

GENERAL INFORMATION

Charging System (Page 2 of 2)

CHARGING SYSTEM - WITH ACTECO ENGINE SYSTEM

- A1 : WITH ACTECO 1.6 - 1.8L ENGINE
- A2 : WITH ACTECO 2.0L ENGINE

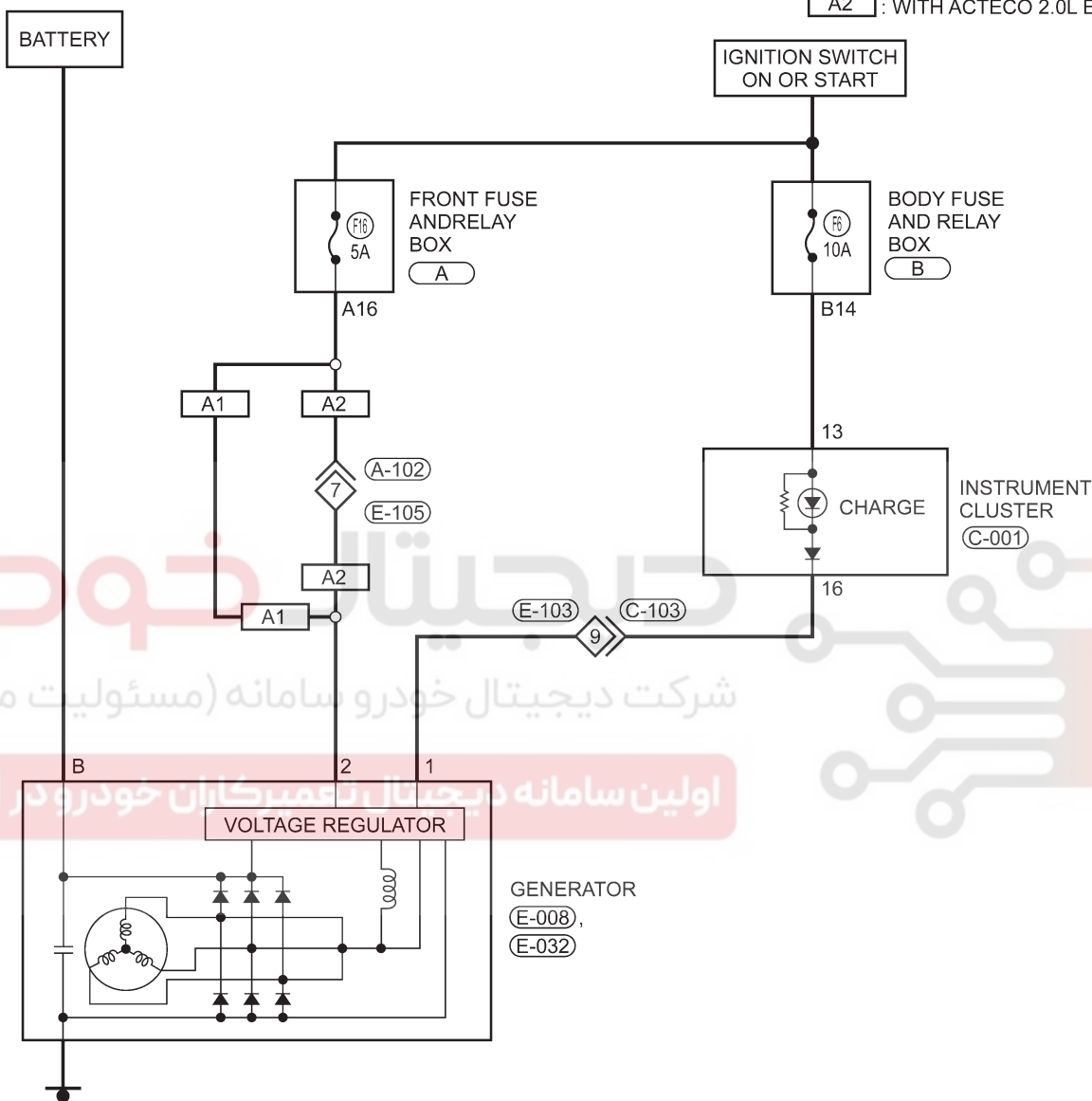

05

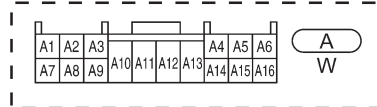
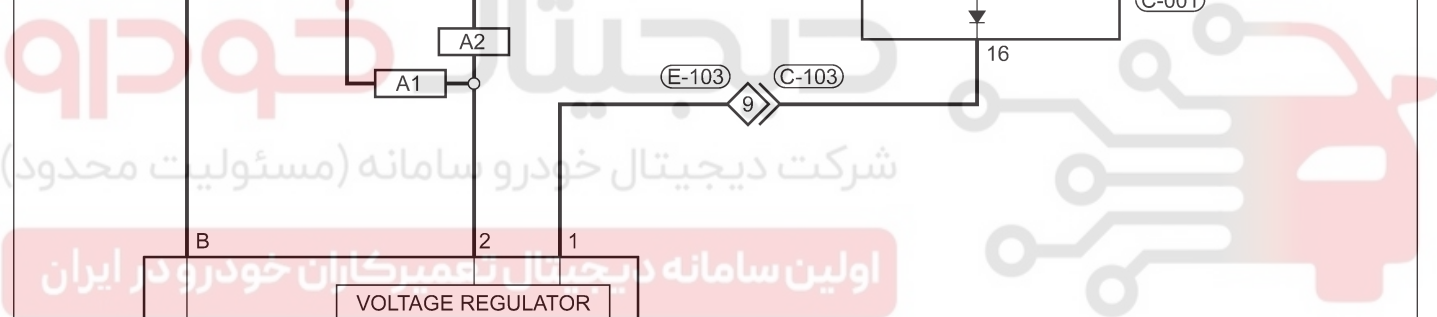

FRONT FUSE AND RELAY BOX

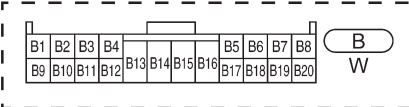

BODY FUSE AND RELAY BOX

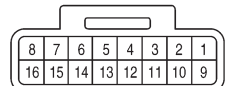

A-102 B

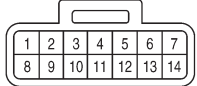

C-103 B

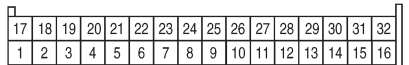

C-001 L

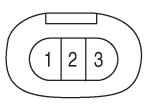

E-008 B

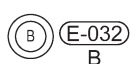

E-032 B