

MFI CONTROL SYSTEM

E88B7CD2

MFI Control System (G6DA-GSL 3.8L) (1)

SD313-1

LAMBDA 3.8L

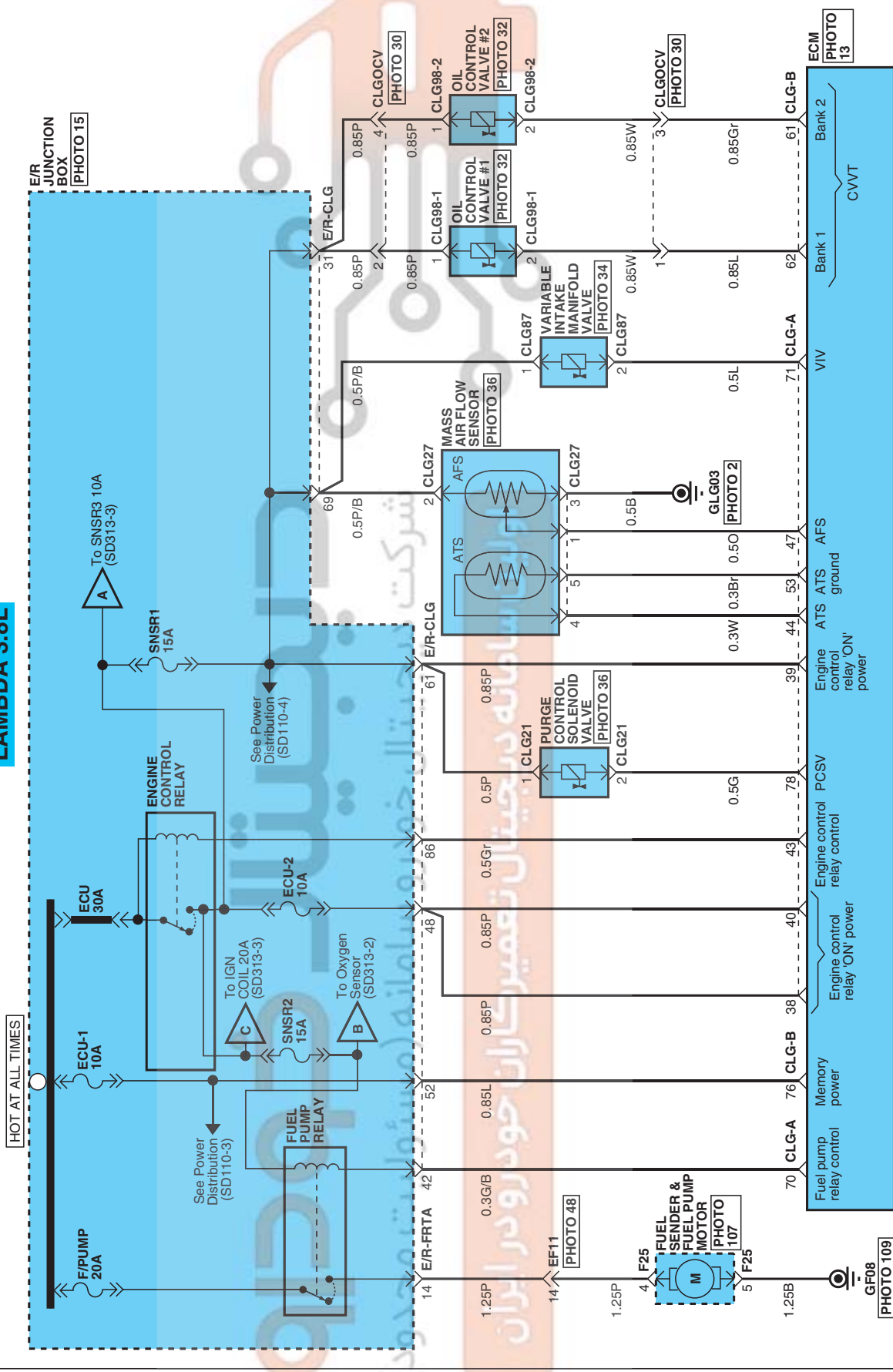

EENS09313A

MFI CONTROL SYSTEM

MFI Control System (G6DA-GSL 3.8L) (2)

SD313-2

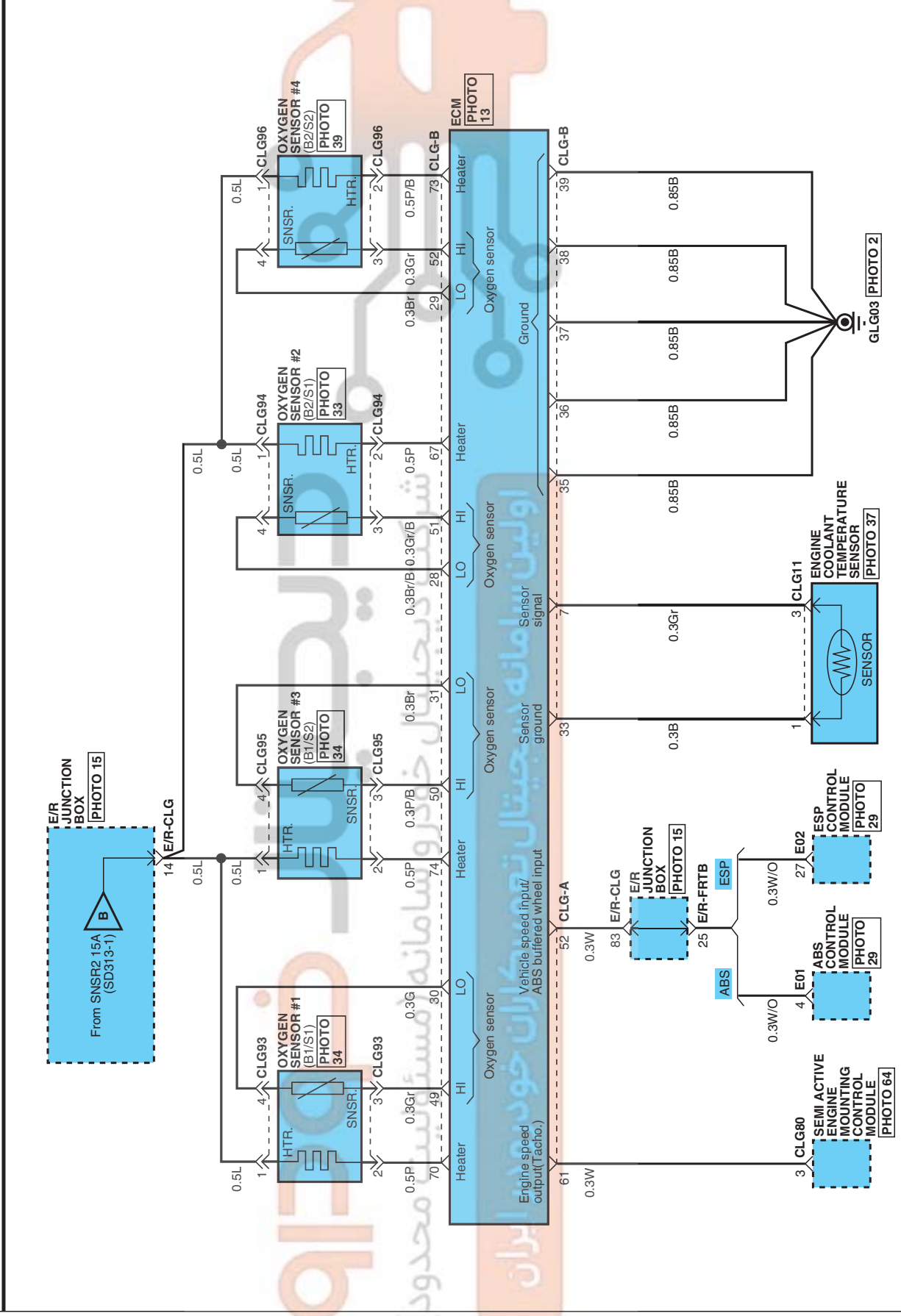

MFI CONTROL SYSTEM

MFI Control System (G6DA-GSL 3.8L) (3)

SD313-3

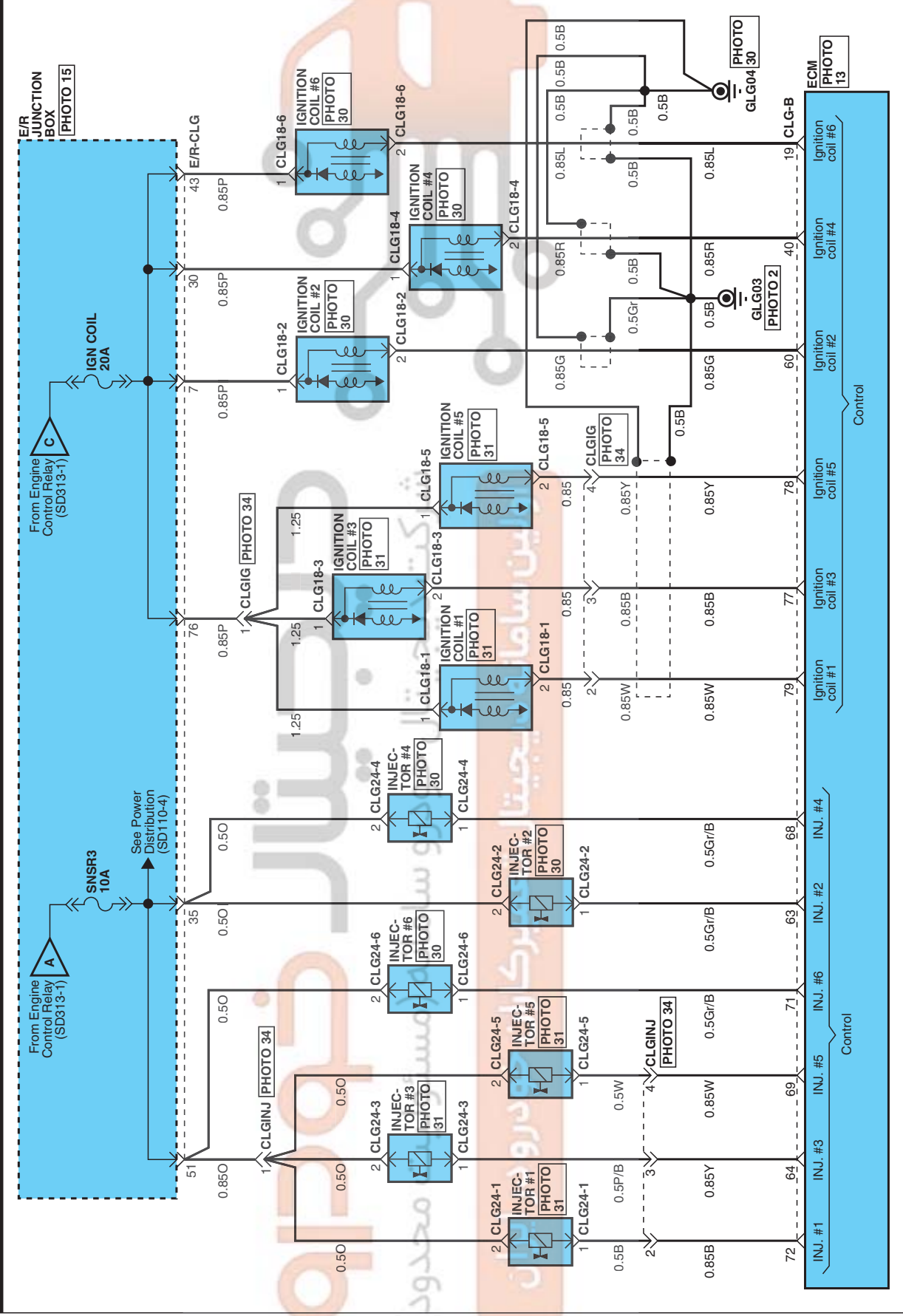

EENS09519CL

MFI CONTROL SYSTEM

MFI Control System (G6DA-GSL 3.8L) (4)

SD313-4

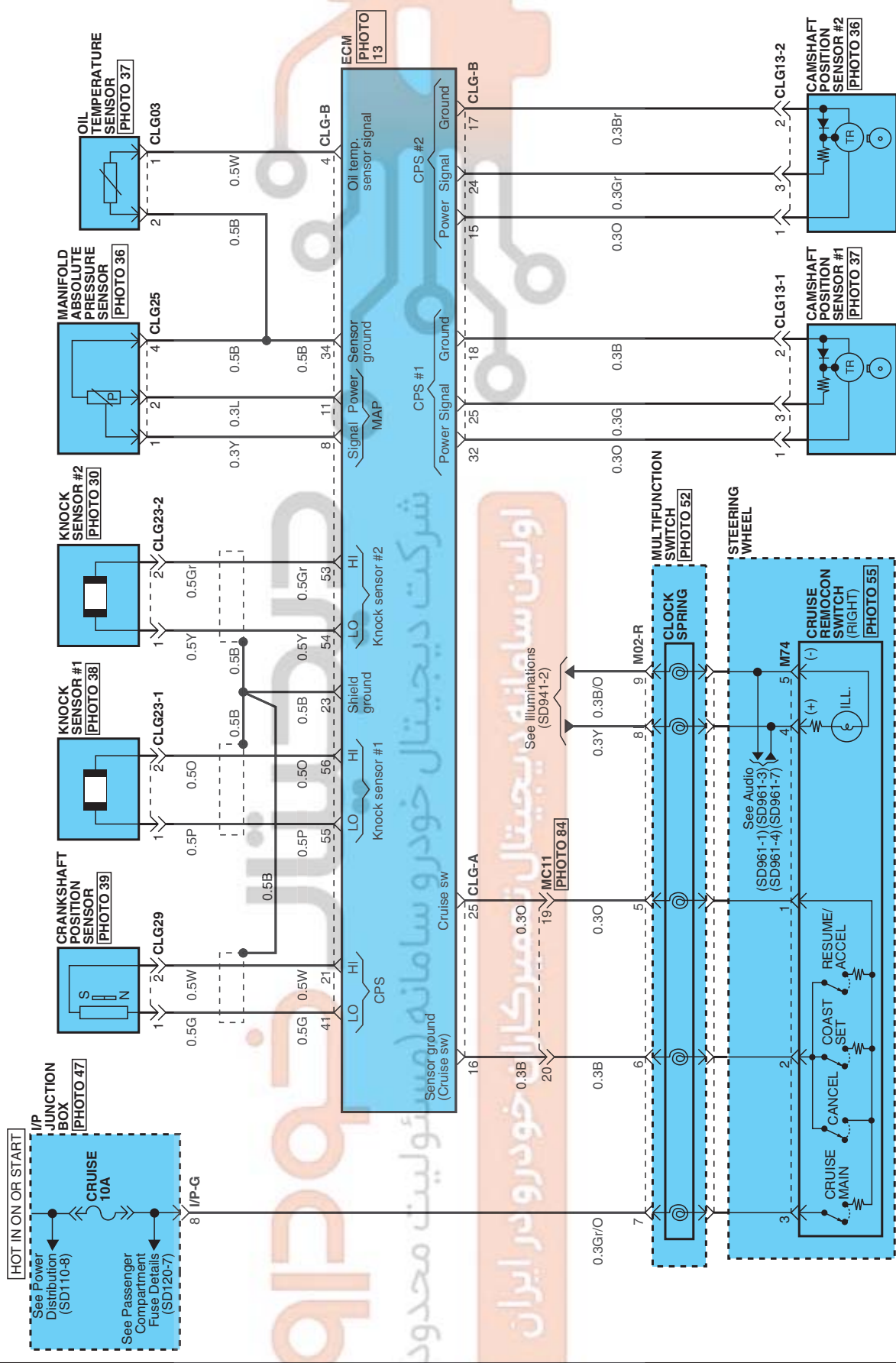

MFI CONTROL SYSTEM

MFI Control System (G6DA-GSL 3.8L) (5)

SD313-5

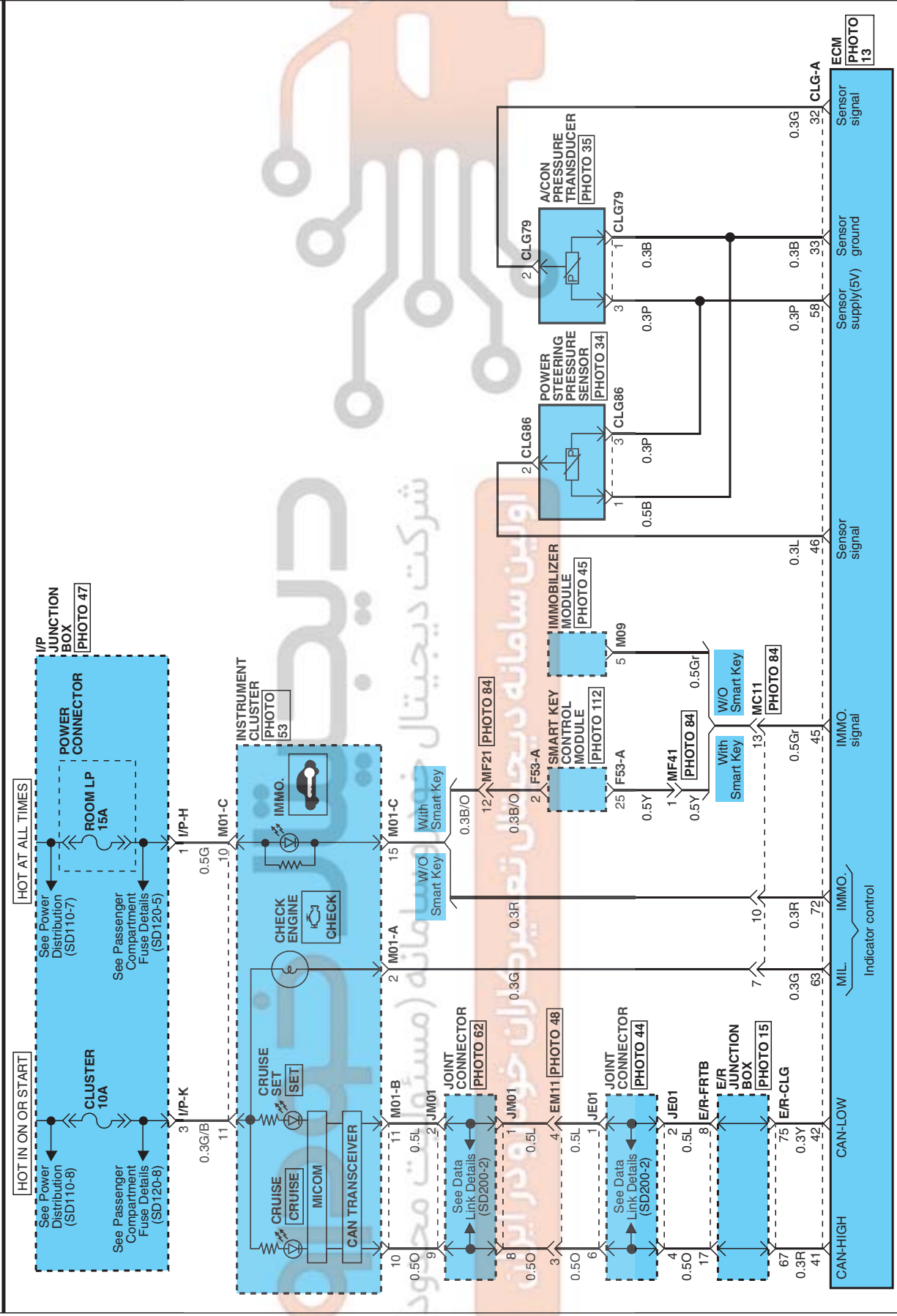

EENS09313EL

MFI CONTROL SYSTEM

MFI Control System (G6DA-GSL 3.8L) (6)

SD313-6

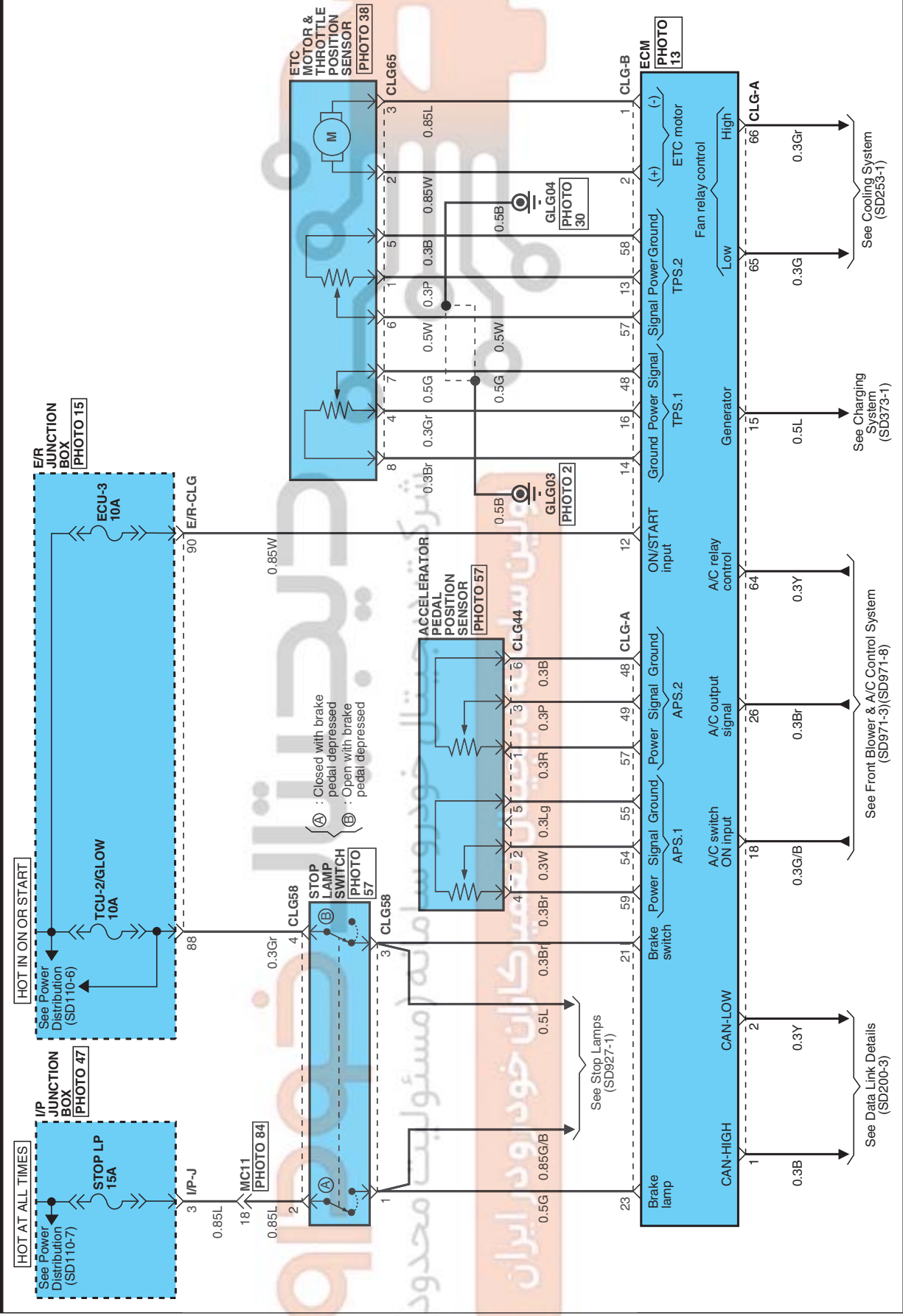

EENS09313FL

MFI CONTROL SYSTEM

MFI Control System (G6DA-GSL 3.8L) (7)

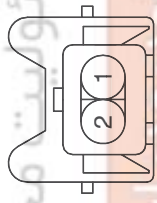
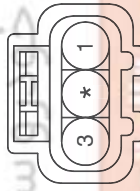
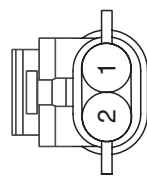
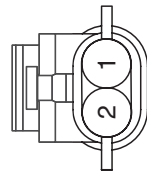
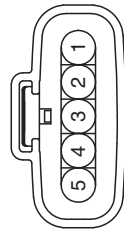
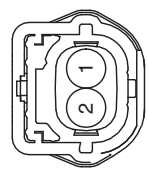
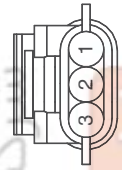
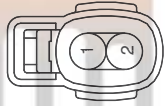
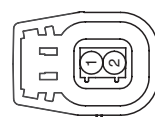
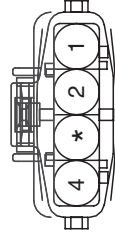
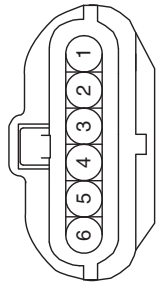
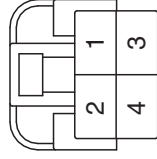

SD313-7

CLG-A	CLG-B
<p>CLG03</p>  <p>AMP_JPT_02F_B_CLIP</p>	<p>CLG11</p>  <p>PKD_ECU_80F_GR_3</p>
<p>CLG21</p>  <p>PKD_MP150_02F_B</p>	<p>CLG23-1,2</p>  <p>PKD_MP150_02F_GR</p>
<p>CLG27</p>  <p>PKD_GT150_06F_B</p>	<p>CLG29</p>  <p>BSH_SENSOR_02F_B</p>
<p>CLG13-1,2</p>  <p>PKD_150WP_03F_B_L</p>	<p>CLG18-1,2,3,4,5,6</p>  <p>KET_090IWP_02F_Gr_VER</p>
<p>CLG24-1,2,3,4,5,6</p> 	<p>CLG25</p>  <p>AMP_JPT_04F_B_BOSCH</p>
<p>CLG44</p>  <p>AMP_070WP_06F_B</p>	<p>CLG58</p>  <p>KET_250DL_04F_W</p>

MFI CONTROL SYSTEM

MFI Control System (G6DA-GSL 3.8L) (8)

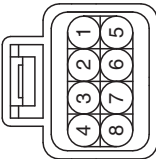
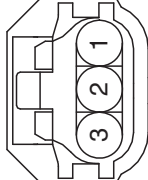
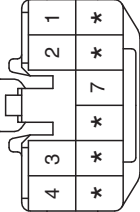
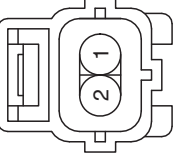
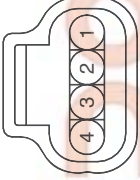
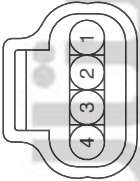
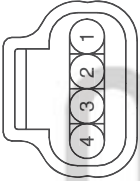
SD313-8

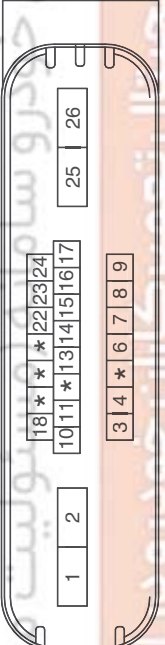
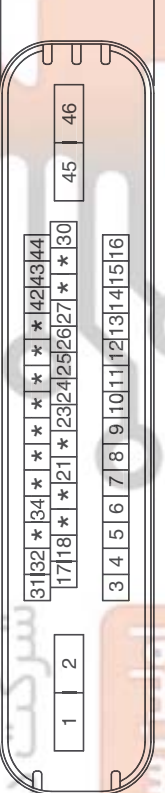
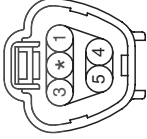
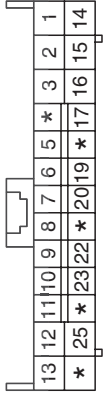
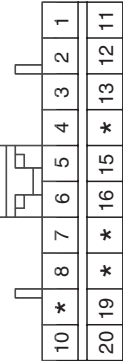
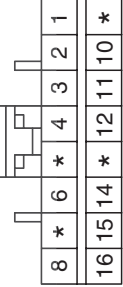
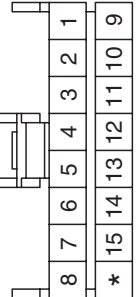
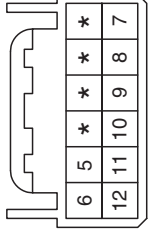
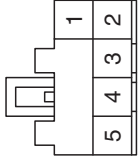
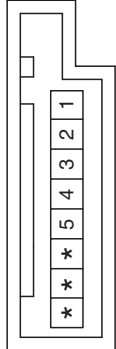
<p>CLG65</p>  <p>PKD_GT150_08F_B</p>	<p>CLG79/CLG86</p>  <p>KET_040_WP_03F_B</p>	<p>CLG80</p>  <p>KET_090IIL_10F_W</p>	<p>CLG87</p>  <p>AMP_EJWP_02F_B</p>
<p>CLG93</p>  <p>PKD_GT150_04F_Gr</p>	<p>CLG94/CLG95</p>  <p>PKD_GT150_04F_B</p>	<p>CLG96</p>  <p>PKD_GT150_04F_Gr</p>	<p>CLG98-1,2</p>  <p>OR02F134</p>
<p>E01</p>  <p>FC1_ABS_26F_B</p>			
<p>E02</p>  <p>FC1_ESP_46F_B</p>			
<p>F25</p>  <p>KET_090IWP_05F_Gr_2</p>	<p>F53-A</p>  <p>AMP_0407_26F_W_HD</p>	<p>M01-A</p>  <p>AMP_040M2_20F_B</p>	<p>M01-B</p>  <p>AMP_040M2_16F_B</p>
<p>M01-C</p>  <p>AMP_040M1_16F_B</p>	<p>M02-R</p>  <p>AMP_025_12F_W</p>	<p>M09</p>  <p>KUM_CDR_05F_W</p>	<p>M74</p>  <p>AMP_1743386-1</p>