

Content

1. Introduction	1	ABS System.....	32
2. Symbol	3	5. Fuse and Relay	33
3. Circuit Diagnosis	4	Engine Compartment Fuse and Relay Box.....	33
Circuit Diagnosis Procedure.....	4	I/P Fuse and Relay Box.....	34
Circuit Diagnosis Device.....	4	6. Ground Distribution	36
Repair Tools.....	5	G01/G03/G04/G11/G12/G13.....	36
Terminal Repair.....	6	G21/G23.....	37
Poor Ground Connection Repair.....	7	G22/G25/G26/G27/G31.....	38
4. Wiring Diagram	8	7. Harness Connector Location View	39
Charging System/Clock/Power.....	9	Engine Harness Connector Location View.....	39
Starting System/Ignition System/Fuel System.....	10	Engine Compartment Harness Connector Location View.....	40
Electronic Control System.....	11	I/P Harness Connector Location View 1.....	41
Cooling System /A/C compressor.....	12	I/P Harness Connector Location View 2.....	42
Air Conditioning/Rear Defroster.....	13	Body Harness Connector Location View.....	43
Cigarette Lighter/Horn.....	14	Door Connector Location View.....	44
Headlamps(DX).....	15	Roof Harness Connector Location View.....	45
Headlamps(LX/EX).....	16	SRS Harness Connector Location View.....	46
Front and Rear Fog Lamp.....	17	8. Ground Point Location View	47
Left and Right Turn Lamp/Hazard Warning Lamp.....	18	G01.....	47
Dome Lamp/Sunroof.....	19	G03/G11/G12/G13.....	48
Door Lamps.....	20	G21/G23.....	49
Width Lamps/Interior Lighting.....	21	G22.....	50
Instrument Cluster(I).....	22	G27.....	51
Instrument Cluster(II).....	23	G25/G26/G31.....	52
CD System.....	24	9. Connector View	53
Power Window.....	25	E1.....	53
Power Rear View Mirror.....	26	EA1-EA2.....	55
Wiper and Washer System.....	27	E2-E3-E4.....	56
Central Lock and Theft Deterrent System.....	28	E5-E6-E7-E8.....	57
Brake Lamp/Reverse Lamp/Reverse Radar System.....	29	E9-E10-E11-E12.....	58
Supplemental Restraint System.....	30	E13-E14-E15-E16.....	59
Driver's Seat Heating System.....	31		

Content

E17-E18-E18-E20-E21.....	60	Body Harness Connector.....	90
E22-E23-E24-E25.....	61	B1-B2-B3-B4.....	90
E26-E27-EC1-EC2.....	62	B5-B6-B7-B8-B9.....	91
Engine Compartment Harness connector.....	63	B10-B11-B12-B13.....	92
U1-U2-U3.....	63	B14-B15-B16-B17-BH1.....	93
U4-U5-U6-U7.....	64	BH2-B20-BD1.....	94
U8-U9-U10-U11.....	65	BD2-BD3-BA.....	95
U12-U13-U14-U15.....	66	BG.....	96
U16-U17-U18-U19-U20-U21.....	67	Door Harness Connector	97
U22-UA-UB1.....	68	D1-D2-D3-D4.....	97
UB2-UB3.....	69	D5-D6-D7.....	98
I/P Harness Connector.....	70	D11-D12-D13-D14.....	99
I1-I2.....	71	D15-D16-D17.....	100
I3-I4-I5-I6.....	72	D21-D22-D23-D24.....	101
I7-I8-I9-I10.....	73	D31-D32-D33-D34.....	102
I11-I12-I13-I14.....	74	DH1-DH2.....	103
I15-I16-I17.....	75	DH3.....	104
I18-I19-I20-I21.....	76	DG-DH4.....	105
I22-I23-I24-I25.....	77	Roof Harness Connector.....	106
I26-I27.....	78	R1-R2-R3.....	106
I28.....	79	RE-RE2.....	107
I29-I30.....	80	SRS Harness Connector.....	107
I31-I32-I33-I34-I35.....	81	S1-S2.....	107
I1A-I1B.....	82	S3-S4.....	108
I1C-I1D-I1E.....	83	SF.....	109
IA1-IA2.....	84	Reverse Radar Harness Connector.....	109
IB1-IB2-IB3.....	85	L1-L2-LH.....	109
ID1-ID2-ID3.....	86	HAVC Harness Connector.....	110
IE-IE2-IF.....	87	A1-A2-A3-A4.....	110
IG-IG2.....	88	A5-A6-A7.....	112
IH1-IH2.....	89	A8-AG.....	113
IH3-IH4.....	90		

Content

10. Abbreviations.....113

دیجیتال خودرو

شرکت دیجیتال خودرو سامانه (مسئولیت محدود)

اولین سامانه دیجیتال تعمیرکاران خودرو در ایران



Introduction

Central Lock and Theft Deterrent System

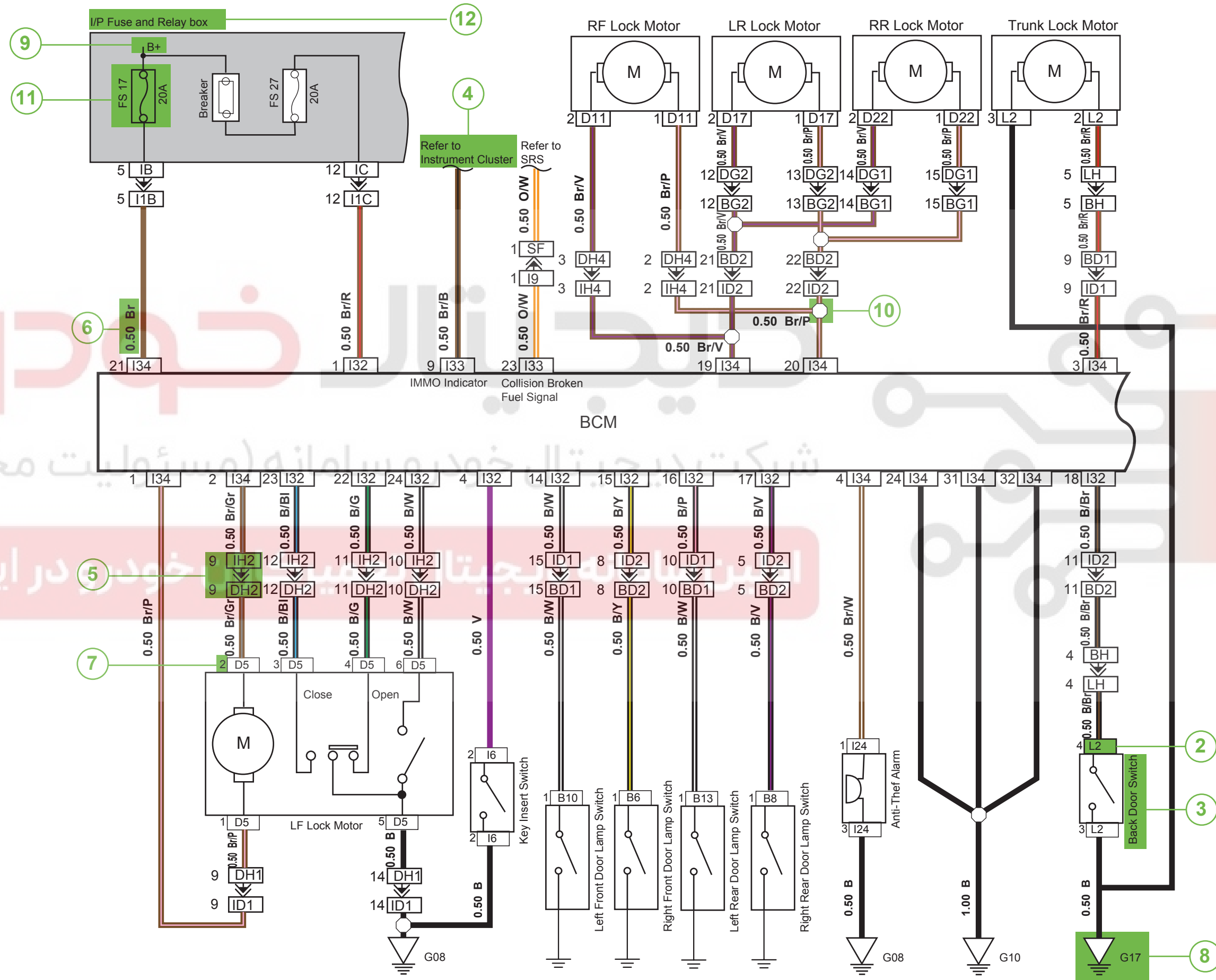

Introduction

1. System name.
2. Harness connector naming.

In this manual, the harness connector naming is based on harness. For example, I/P connector is named as I23. I is the harness code, 23 is the connector number.

The table below lists all harness:

Code	Harness
U	Engine compartment harness
U--	Engine compartment harness connector
E	Engine harness
E--	Engine harness connector
I	Instrument panel harness
I--	Instrument panel harness connector
B	Body harness
B--	Body harness connector
D	Door harness
D--	Door harness connector
S	Airbag harness
S--	Airbag harness connector
L	Back door harness
L--	Bak door harness connector
R	Roof harness
R--	Roof harness connector
A	HVAC harness
A--	HVAC harness connector

Note:

- 1 Door harness includes four door harnesses.
- 2 For hareness connector details, please refer to connector location views.
3. Component name.
4. System information.
5. Harness to harness connector. The character in the box is the connector code.
6. Wire color and diameter. The following table shows the color code.

Color Code	Wire Color	Legend
B	Black	■
Br	Brown	■
Bl	Blue	■
G	Green	■
Gr	Grey	■
O	Orange	■
P	Pink	■
R	Red	■
V	Purple	■
W	White	▬
Y	Yellow	■

If a wire has two colors, the first character shows the background color and the second shows the stripe color, divided by “/”.

For example, **YE/WH** means yellow background color with white stripe.

7. Pin number. The connector pin numbers are mirrored to the ones that connect to them, as shown below:

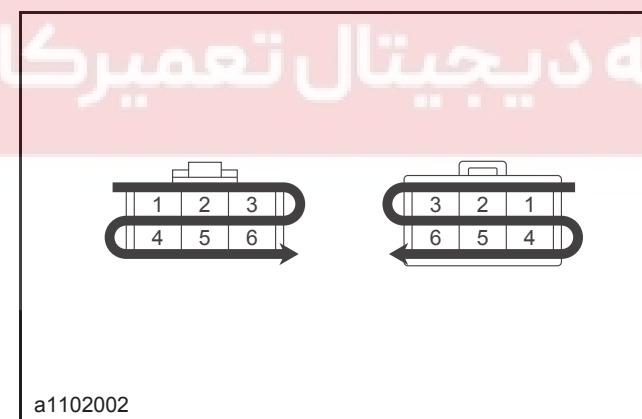

8. Ground number. The ground number starts with G. For ground details, please refer to ground location views.
9. Fuse supply. +B represents battery power supply. ACC represents power supply when ignition switch is at “ACC” position. IG2 represents power supply from terminal 4 when ignition switch is at “ON” position. IG1 represents power supply from terminal 2 when ignition switch is at “ON” position.

Note: The difference between IG1 and IG2 is that there is power supply output from IG1, but not from IG2 when the ignition switch is at “ST” position.

10. Splice

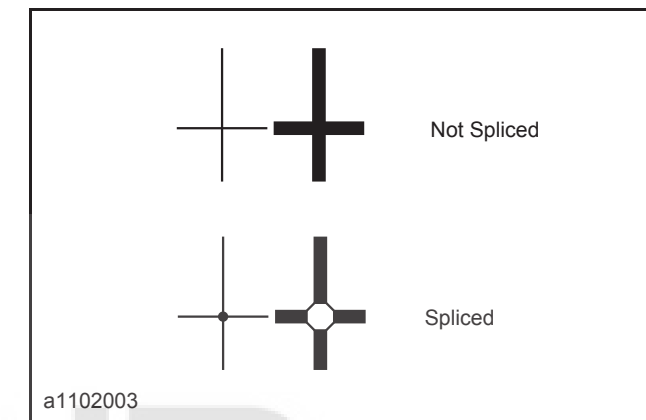

11. Fuse number consists of fuse code and a sequential number.

12. Grey shade means fuse and relay box.

Symbol

	Ground		Relay-Normally Closed		Battery
	Temperature Sensor		Relay-Normally Open		Capacitor
	Solenoid		Double Throw Relay		Cigarette Lighter
	Solenoid		Resistor		Antenna
	Light Load Fuse		Potentiometer		Switch-Normally Open
	Moderate Load Fuse		Rheostat		Switch-Normally Closed
	Heavy Load Fuse		Ignition Coil		Double Throw Switch
	Heater		Knock Sensor		Ignition Switch

	Diode		Bulb		UTP (Unshielded Twisted Pair)
	Photodiode		Wire Direction		Starter
	Light Emitting Diode		Horn		Fan Assembly
	Motor		Clock Spring		Oxygen Sensor
	Limit Switch		Airbag		Low Speed Fan Relay B
	No Splice		Splice		

a1104002

Circuit Diagnosis

Circuit Diagnostic Procedure

Refer to the following procedure for the circuit diagnosis:

1. Confirm the Fault

To do the proper repair, confirm the fault described by the customer firstly. Inspect the relevant component carefully and make record. DO NOT disassemble the component before confirmation of the fault scope and causes.

2. Read the Wiring Diagram and Analyze the Causes.

Make a complete analysis on the faulty components from power supply to ground according to the sub-system wiring diagram and determine the repair solution. If can not determine the repair solution, please read the system description in the "Description and Operation" in the workshop manual to clear the working principle. And inspect other circuits that has common part with the faulty circuit, for example, the fuse, ground, switch, etc. Inspect the circuit not covered in step 1. If other components on the common circuit work properly, it means the fault exists in its own circuit. Otherwise, the fuse or ground might has faults.

3. Inspect the Circuits and Components.

Always use the wiring diagram together with workshop manual and refer to the diagnostic procedure for the relevant circuits or components in the workshop manual. For the circuit with a control module, fully use diagnostic tools to do the test. Effective diagnosis should be a logical and reasonable operation. Fully use the diagnostic procedures in the workshop manual and start the inspection from the most likely causes and the compents be easiest to inspect.

4. Repair

Repair the faulty circuit. Refer to the wiring diagram and workshop manual for fault treatment. For example, the treatment on bad connection to ground and the harness connector.

5. Confirm the Fault Removed.

After repair, confirm the fault removed and all functions work properly. For the fuse blown fault, check all the relevant circuits.

Circuit Diagnostic Device

1. Voltmeter and Test Light

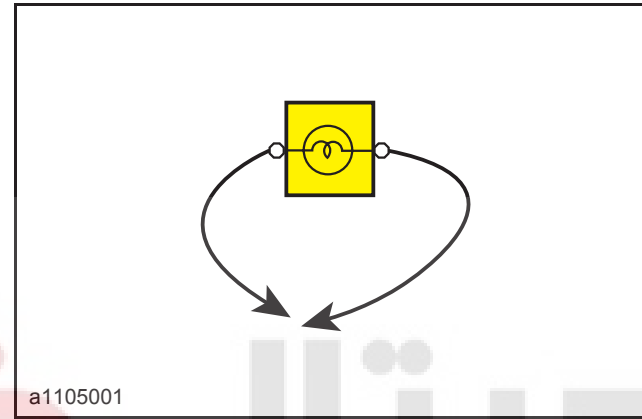

a1105001

Use test light or voltmeter to check the circuit status.

Test light comprises a pair of wires and a 12V bulb. When inspecting, connect one wire to the ground and the other one to the measurement point. If the bulb is lit, it means the measurement point has power supply.

Warning : DO NOT use test light to test the control module voltage. To do so, it could damage the circuit inside the control module. Please use a voltmeter with 10M Ω or higher internal impedance (e.g. to test the ECM voltage.).

Voltmeter has the same connection method as the test light, but voltmeter can display the voltage value of the circuit. Use a voltmeter with high impedance to test the voltage. If the circuit has poor connection, the voltmeter may show the normal value, but the voltage can not drive the load successfully.

2. Test Light with Self-supply and Ohmmeter

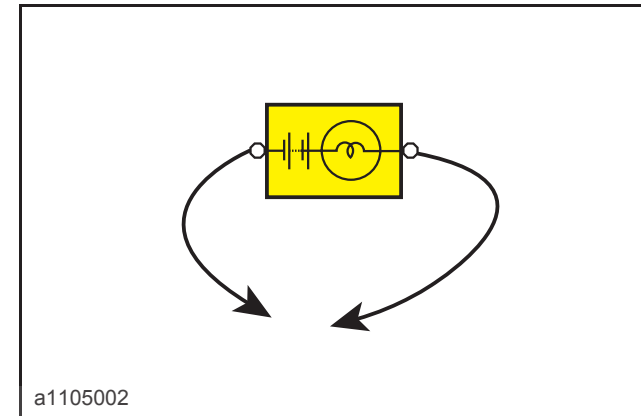

a1105002

Use test light with own 12V power supply or ohmmeter to test the circuit continuity. Test light comprises a bulb, battery and a pair of wires. The bulb will be lit when the two wires contacted. Before test, disconnect the battery negative and pull out the fuse of the circuit to be tested. To test the circuit continuity, contact two wires to the two measurement points. If the bulb is lit, it means the circuit is continuous.

Warning : DO NOT use test light with self-supply to test the control module. To do so, it could damage the circuit inside the control module. Please use a ohmmeter with 10M Ω or higher internal impedance.

Ohmmeter has the same usage method as voltmeter, but ohmmeter can show the impedance value. The lower impedance, the better continuity.

3. Jumper with Fuse

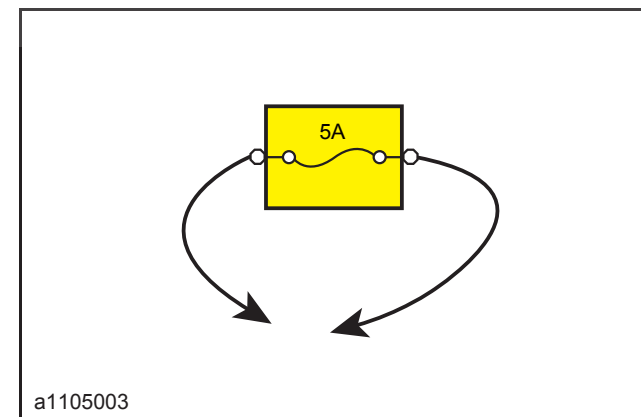

a1105003

Use jumper to test a broken point for open loop circuit (circuit broken). The jumper

should be in tandem with the circuit to be tested.

Warning : To protect the circuit, DO NOT use the fuse with higher rated capacity than the circuit to be tested. DO NOT use the jumper as the input or output signal when a control module like ECM, TCM is in the circuit. To do so, it could damage the circuit inside the control module.

Fault Test

1. Voltage Test

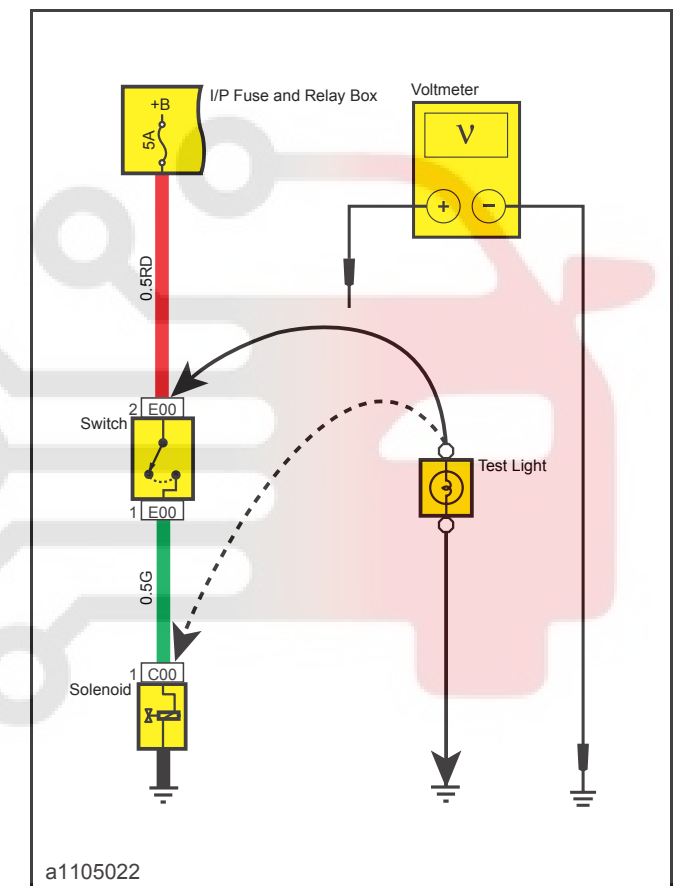

a1105022

Voltage test process is to test the voltage at a certain point. When testing the connector terminals, insert the positive probe into the wire instead of breaking the harness.

- 1 When testing the voltage with test light or voltmeter, connect the negative wire of the test light or the negative probe of the voltmeter to the ground.
- 2 Connect the other wire of the test light or the positive probe of the voltmeter to the place to be tested.

Circuit Diagnosis

3 It means circuit fault if light is not lit. If using voltmeter and voltage display is lower than the rated value with more than 1V, it means the circuit fault.

2. Power Test

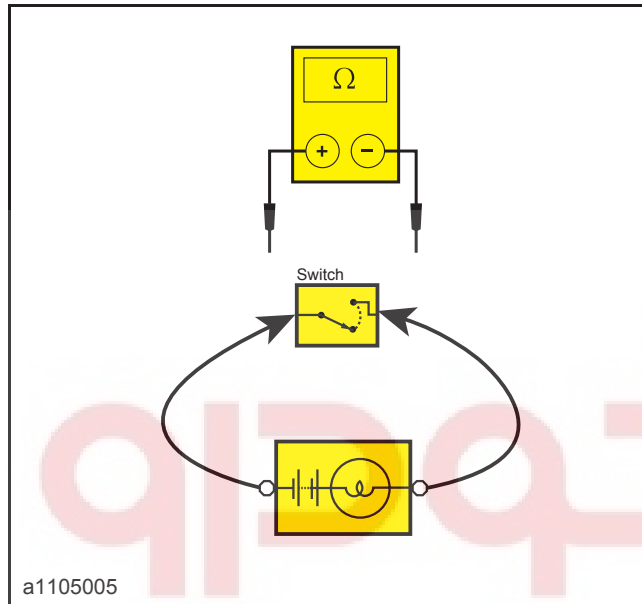

- 1 Disconnect the battery negative.
- 2 Connect one of the wire of the test light with self-supply or the probe of the ohmmeter to the component to be tested. If using ohmmeter, please contact the two probes each other and use reset button to adjust the ohmmeter to zero.
- 3 Connect the other wire of the test light or probe of the ohmmeter to the other side of the load to be tested.
- 4 If the bulb is lit, it means the circuit is continuous. If using ohmmeter, the impedance value should be very small or close to 0Ω.

3. Short Circuit Test

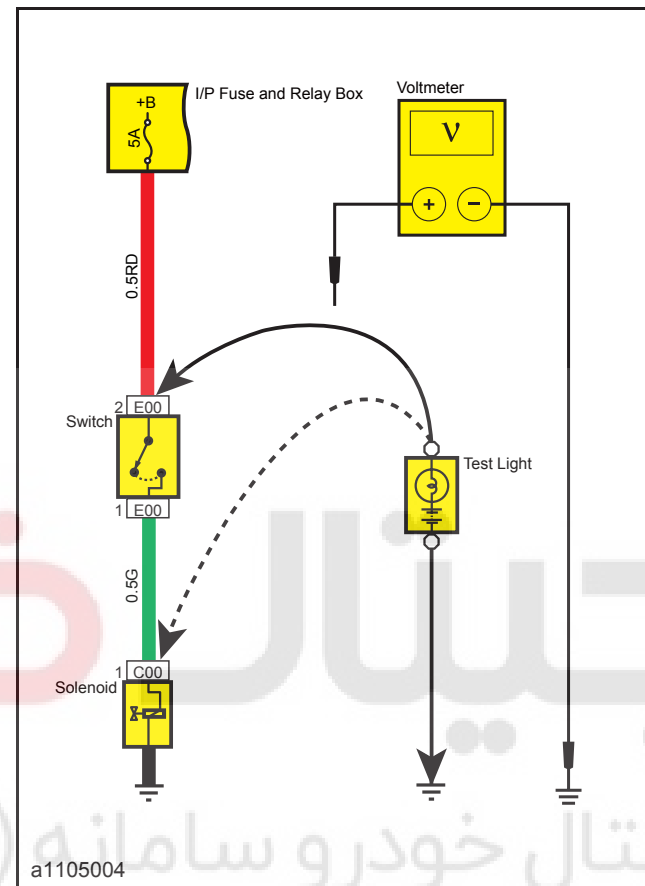

- 1 Disconnect battery negative.
 - 2 Connect one of the wire of the test light with self-supply or the probe of the ohmmeter to the outlet terminal of the fuse.
 - 3 Connect the other wire of the test light or probe of the ohmmeter to the ground.
 - 4 Disconnect all the loads to the fuse.
- Note:** If not disconnect all the loads to the fuse, when testing the low impedance circuit like lights, the ohmmeter will always display the low impedance value. This will cause wrong judgement.
- 5 Do the careful test from the place closest to the fuse.
 - 6 If the bulb is lit or ohmmeter has value display less than 5 Ω, it means the short circuit to the ground.

4. Voltage Drop Test

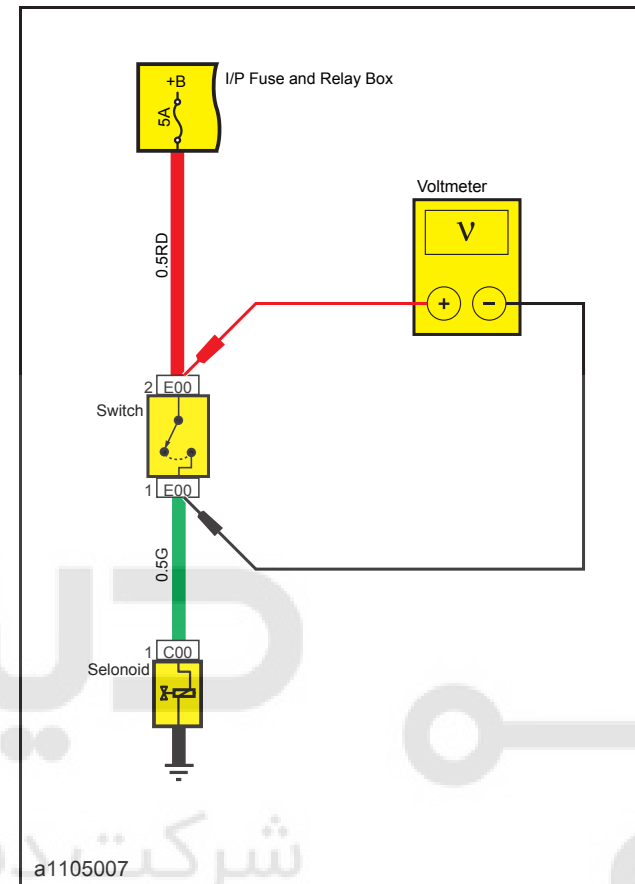

This is to test the voltage drop along the wire, connector or switch.

- 1 Connect the positive probe of the voltmeter to the end of the circuit close to the battery (connector or switch side).
- 2 Connect the negative probe to the other end of the circuit (the other side of the connector or switch).
- 3 Disconnect switch or connect it.
- 4 The voltmeter will display the voltage drop between the two test points.
- 5 If the drop is more than 0.1 V (less than 50 mV for 5 V voltage circuit), it means the circuit fault. Check loose, oxidation or corrosion circuit.

Repair Tools

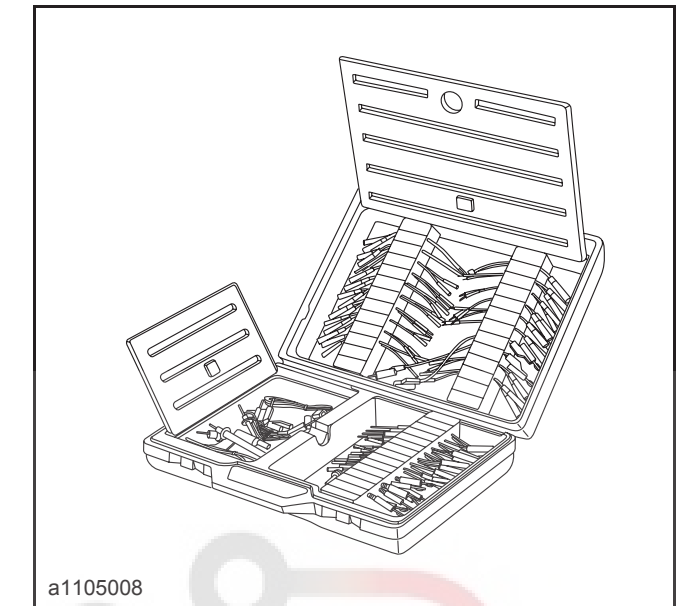

1. 5 KΩ Rheostat

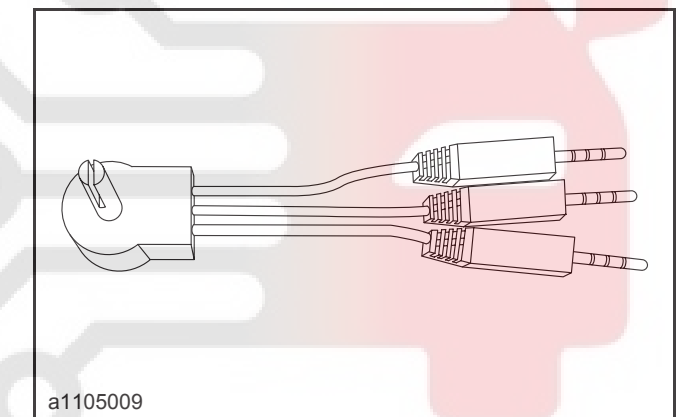

It can simulate ohm-type sensor signals, like coolant temperature sensor, air intake temperature sensor, etc. And help to make quick adjustment on the performance of the component.

2. LED Test Light

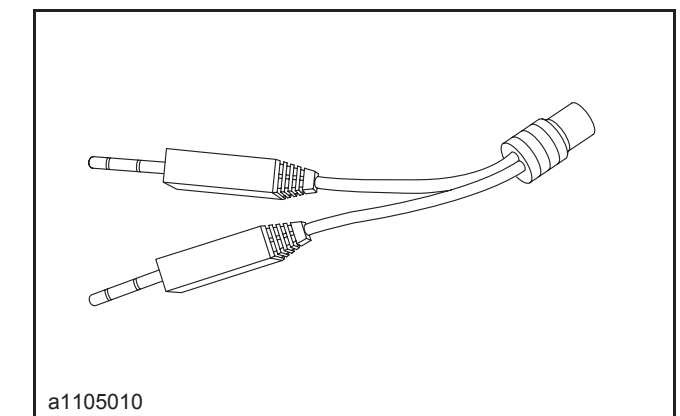

Circuit Diagnosis

Bi-direction two-color LED light can change its color when exchanging the positive and negative. This feature can be used to test the PWM control signals of Hall sensor.

3. Airbag Test Tool

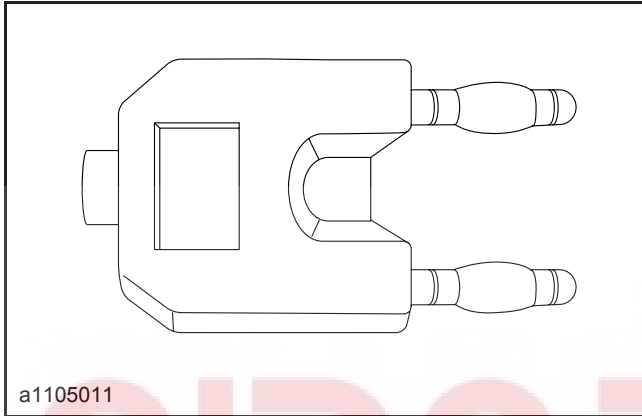

Before installing a new airbag, plug this tool to the airbag system, and use diagnostic tools to test the airbag system to confirm it works properly. After that, remove the airbag test tool and install the new airbag. This process can guarantee a safe airbag operation.

4. Probe

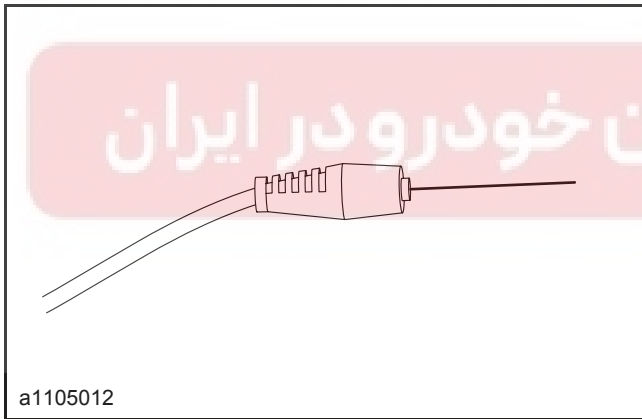

When testing a system component, insert this tool into the connector from the back and do not need to break the harness.

5. Terminal Repair Tool

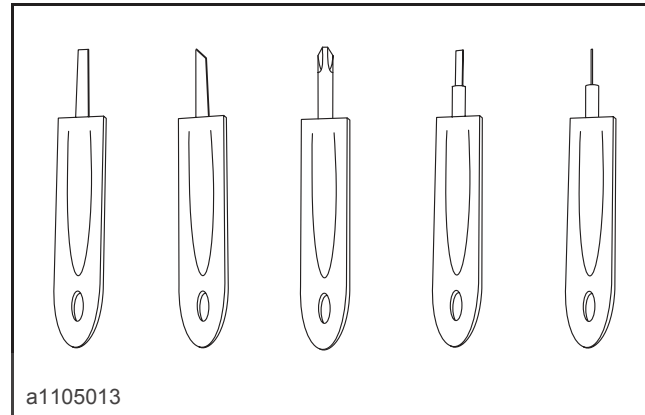

When repairing the terminals, use this tool to separate them from the connector.

Terminal Repair

1. Remove the terminal pin.

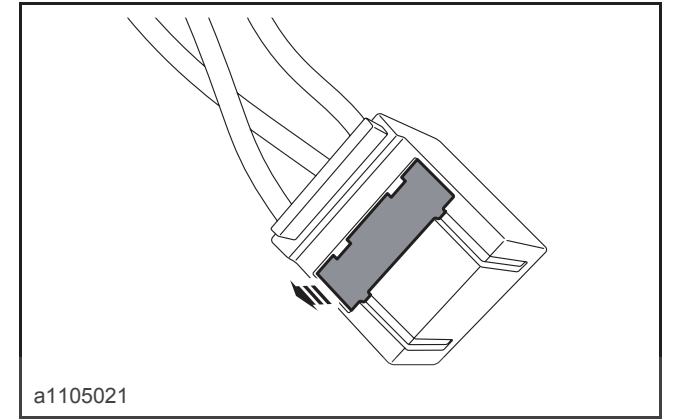

2. Fix the clip with terminal repair tool.

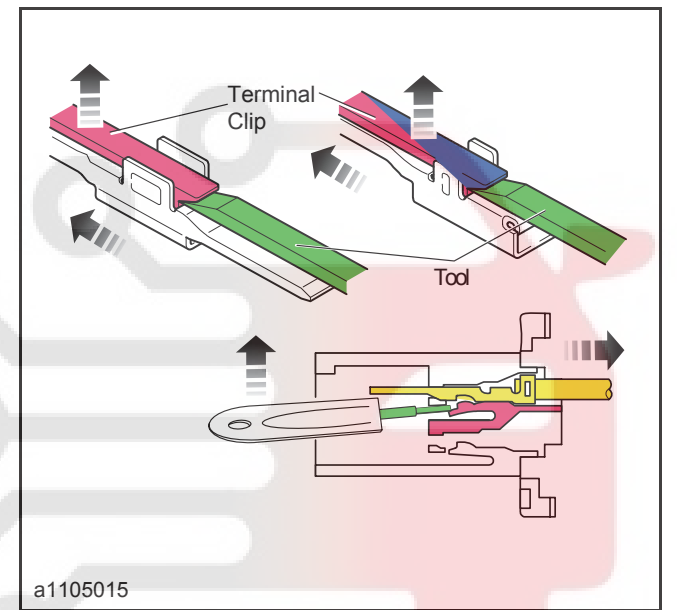

3. Pull out the terminal from the rear of connector.

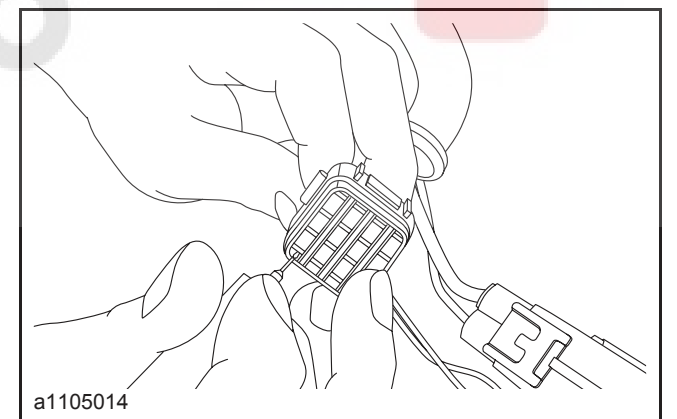

Circuit Diagnosis

4. Clean and repair the terminals.

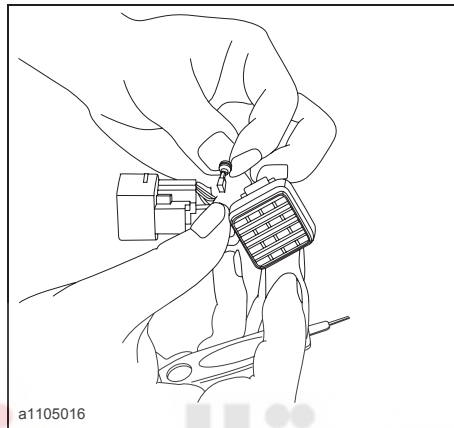

a1105016

Poor Ground Connection Repair

1. Remove the ground bolt.

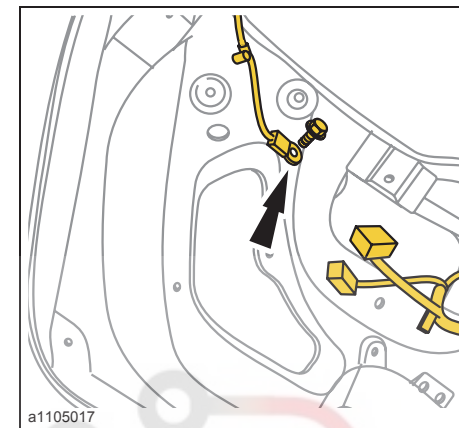

a1105017

2. Clean the two surfaces (both bolt side and car contact side) of the copper ring with grit cloth until the oxide completely cleared.

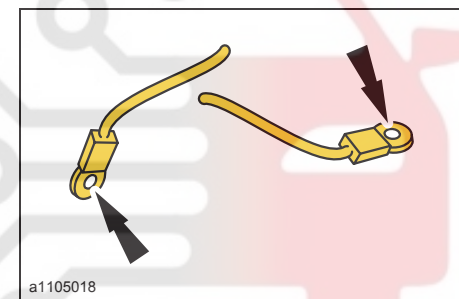

a1105018

3. Clean the ground surface on the car with grit cloth until it completely clean.

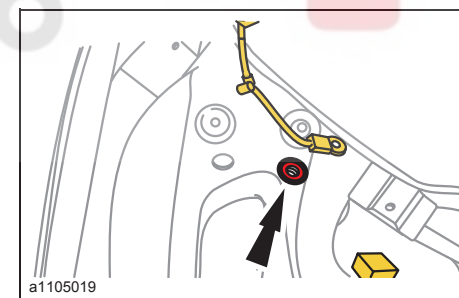

a1105019

دیجیتال خودرو
 شرکت دیجیتال خودرو سامانه (مسئولیت محدود)
 اولین سامانه دیجیتال تعمیرکاران خودرو در ایران

Circuit Diagnosis

4. Install the harness and the bolt. Tighten to specified torque.

Torque: M6 Bolts 8 Nm

M8 Bolts 20 Nm

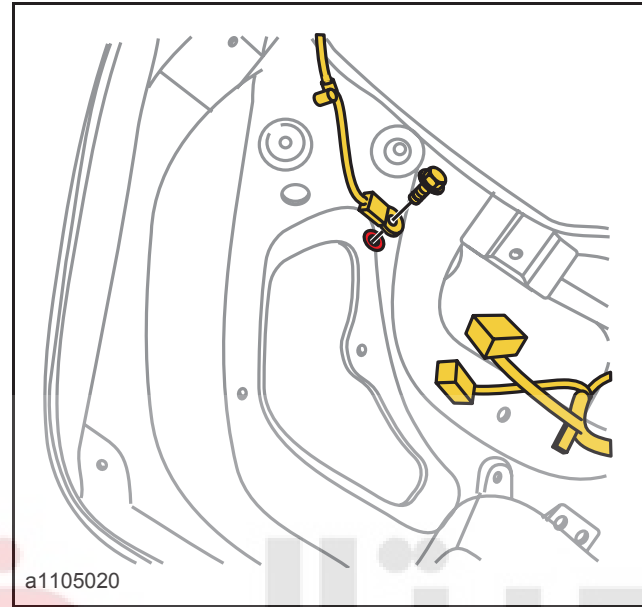

دیجیتال خودرو

شرکت دیجیتال خودرو سامانه (مسئولیت محدود)

اولین سامانه دیجیتال تعمیرکاران خودرو در ایران

Charging System/Clock/Power

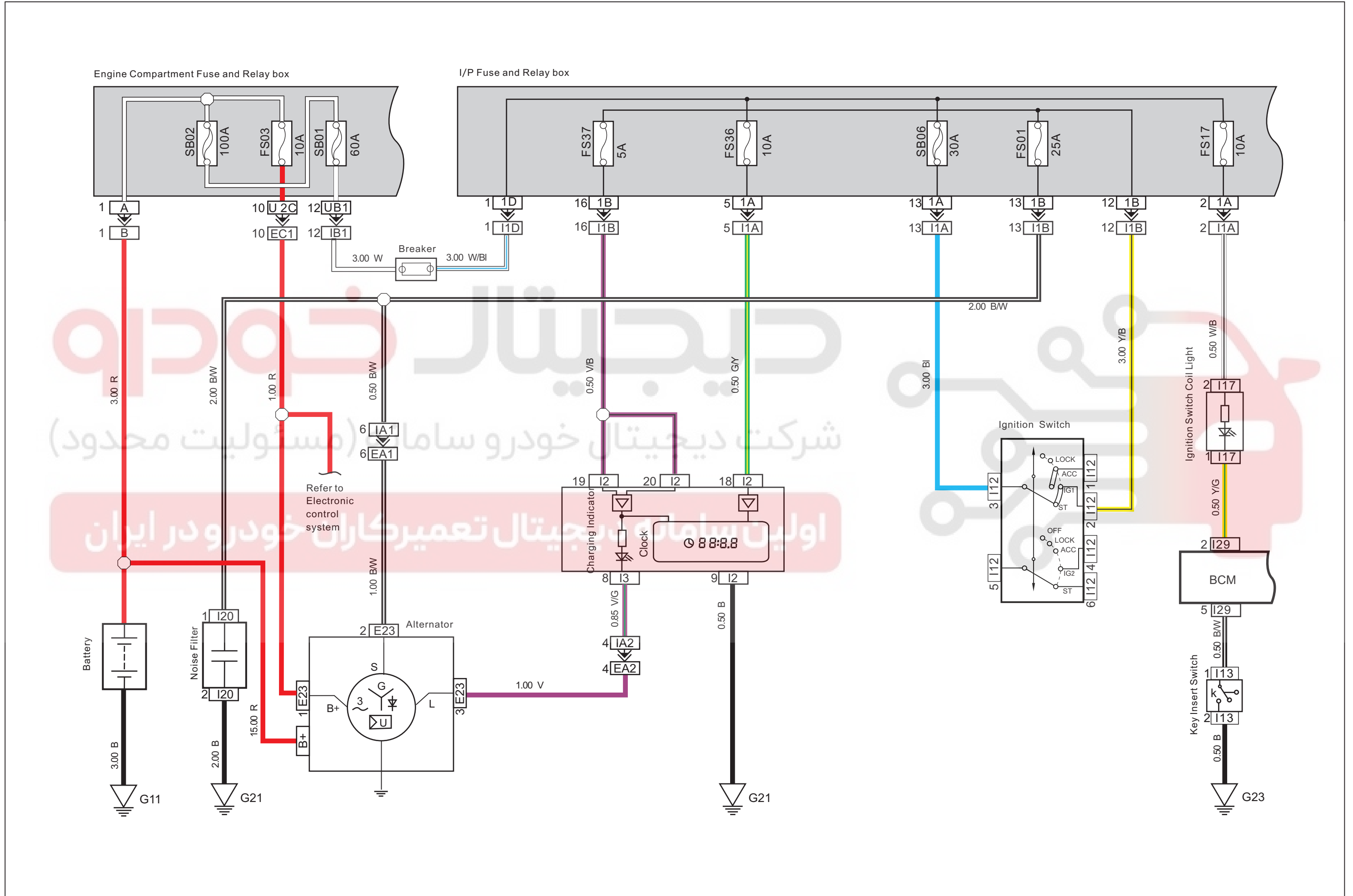

Starting System/Ignition System/Fuel System

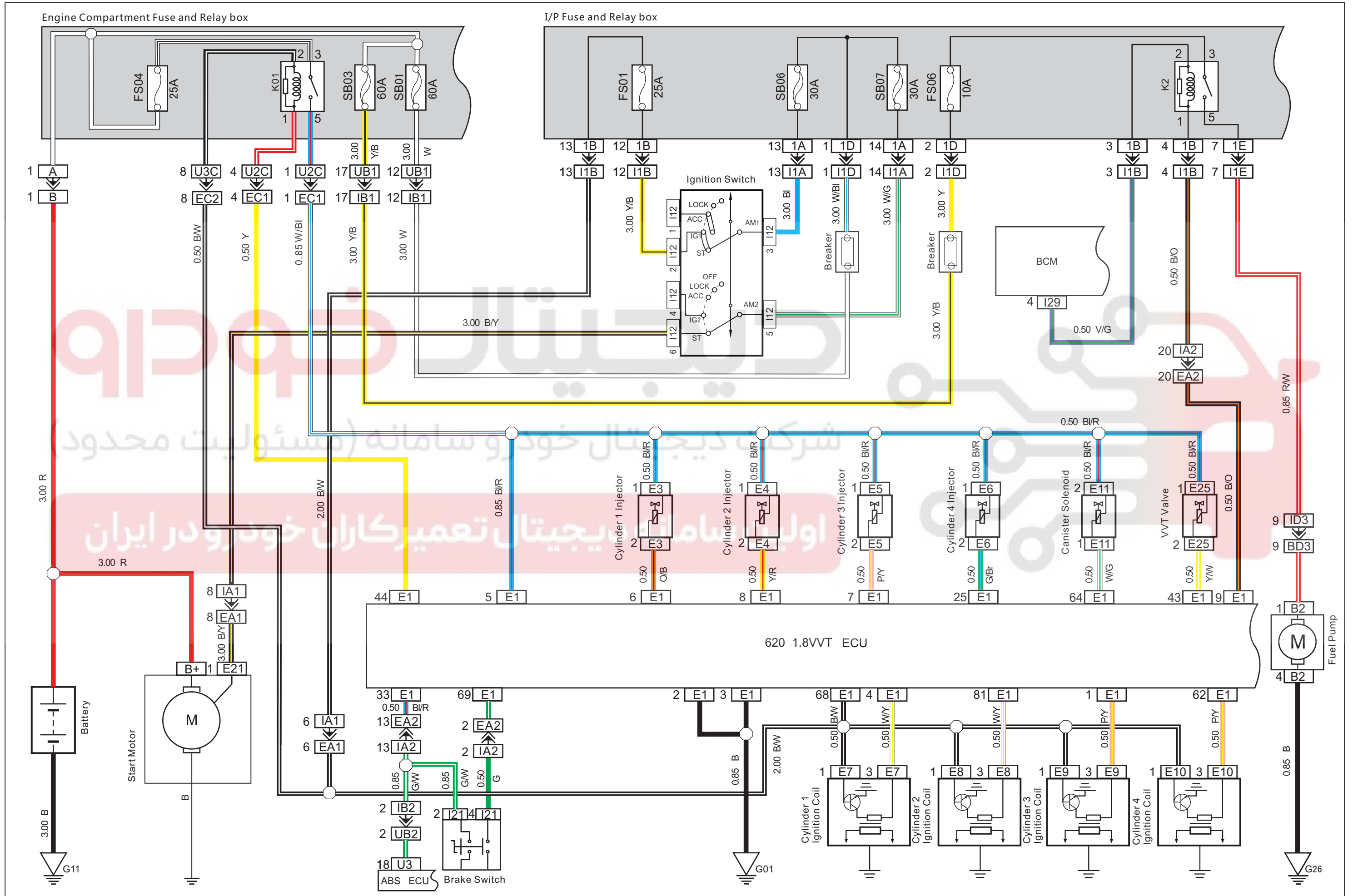

Electronic Control System

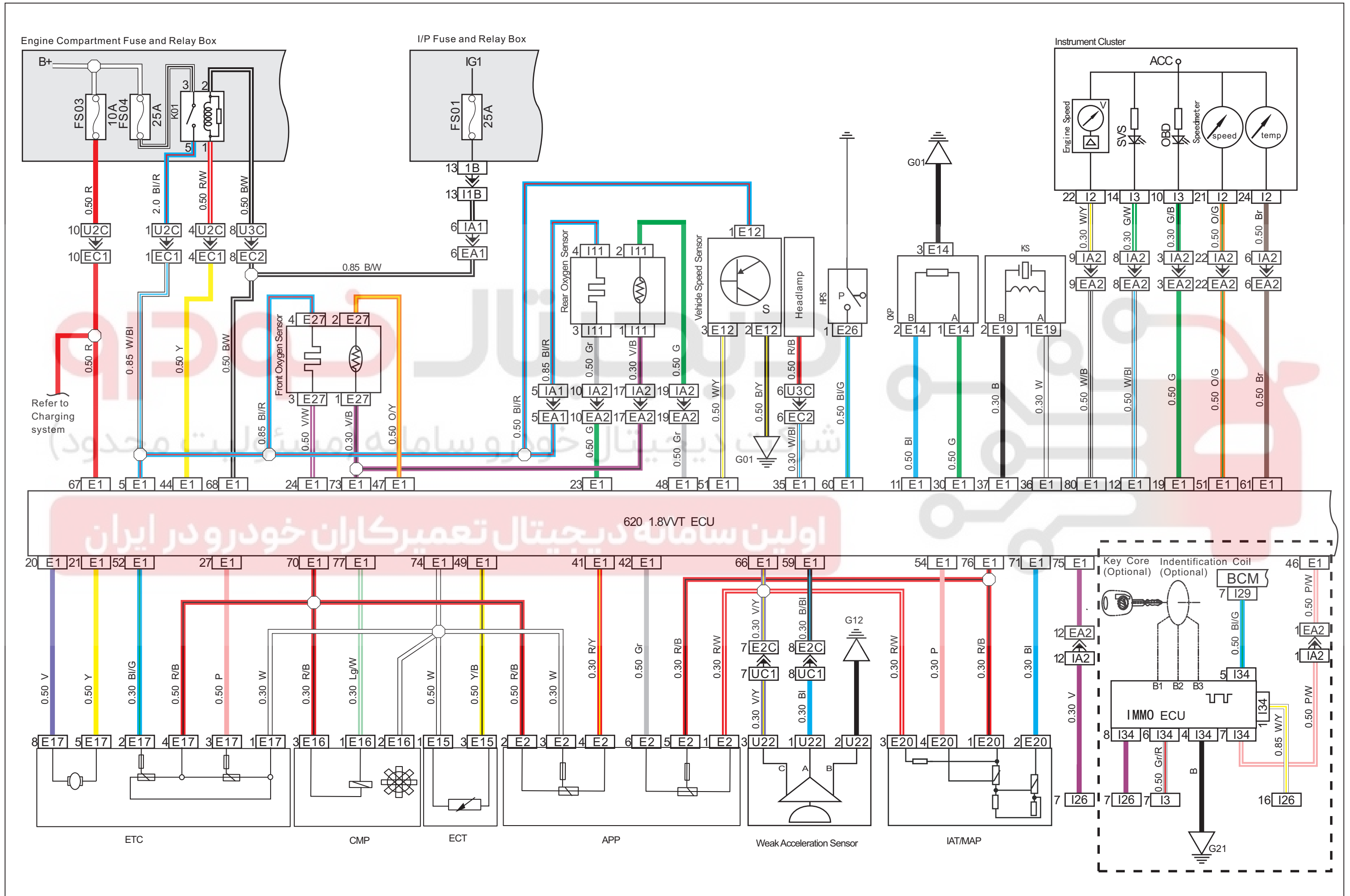

Cooling System/A/C Compressor

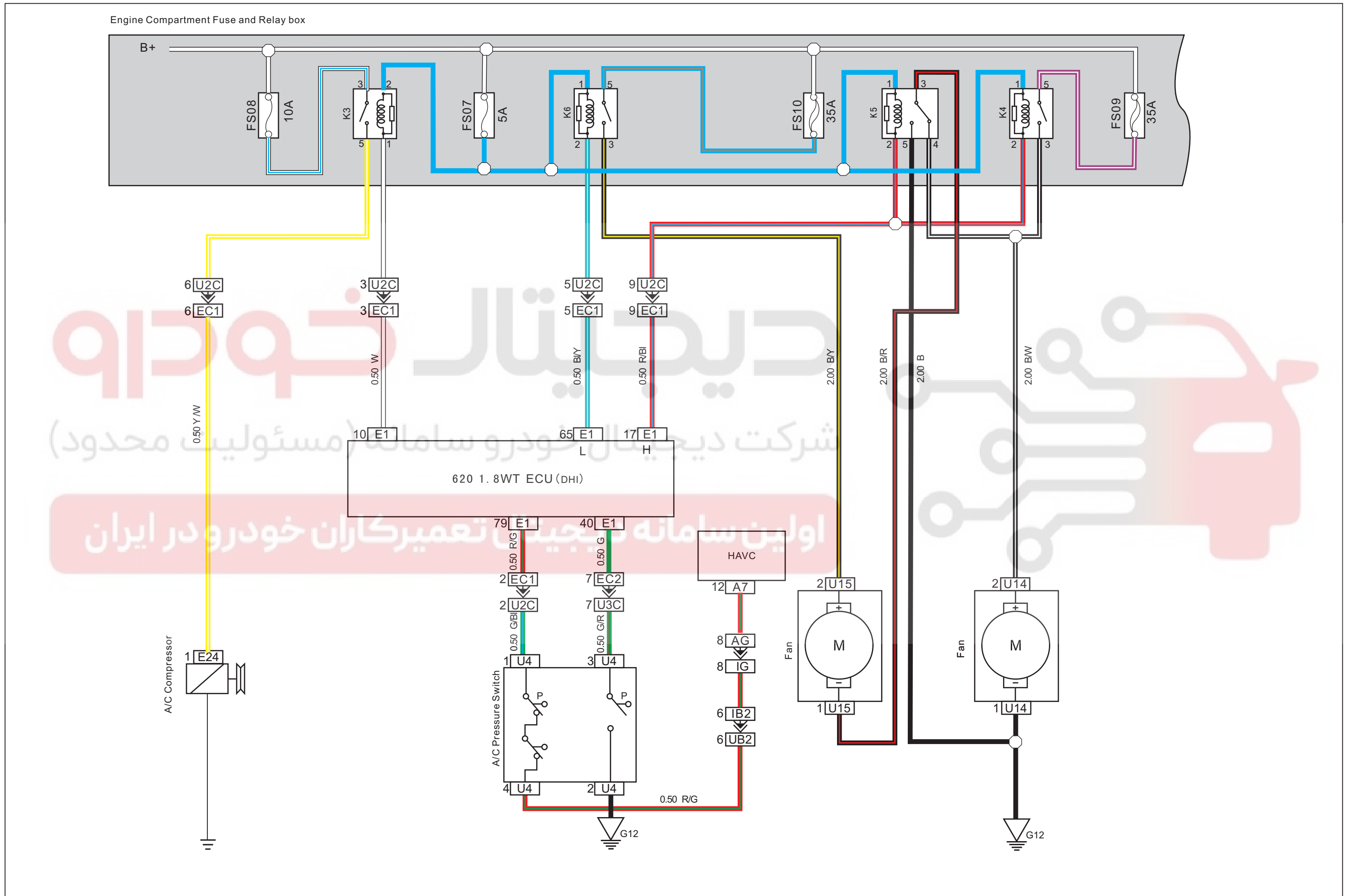

Air Condition/Rear Defroster

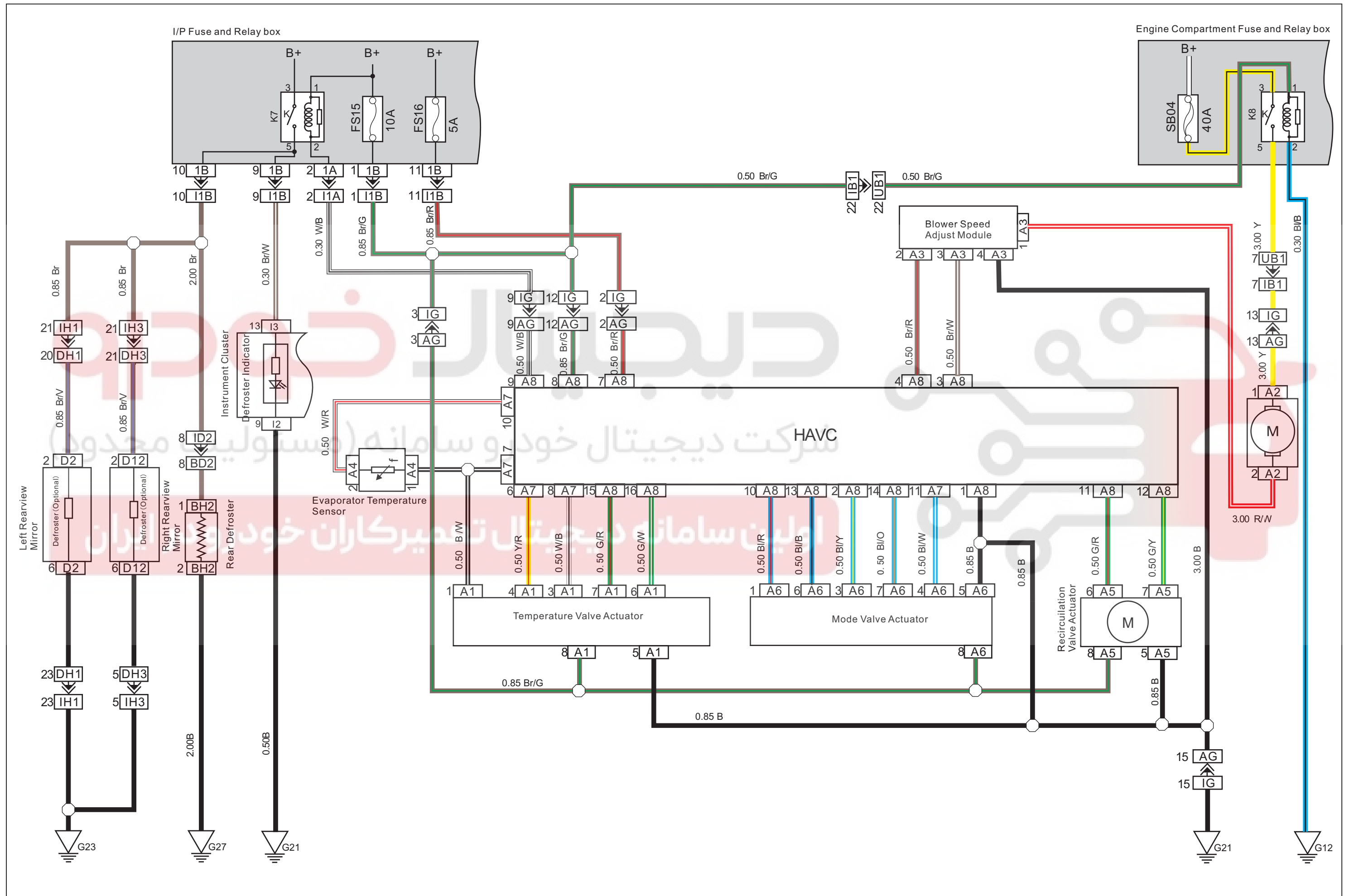

Cigarette Lighter/Horn

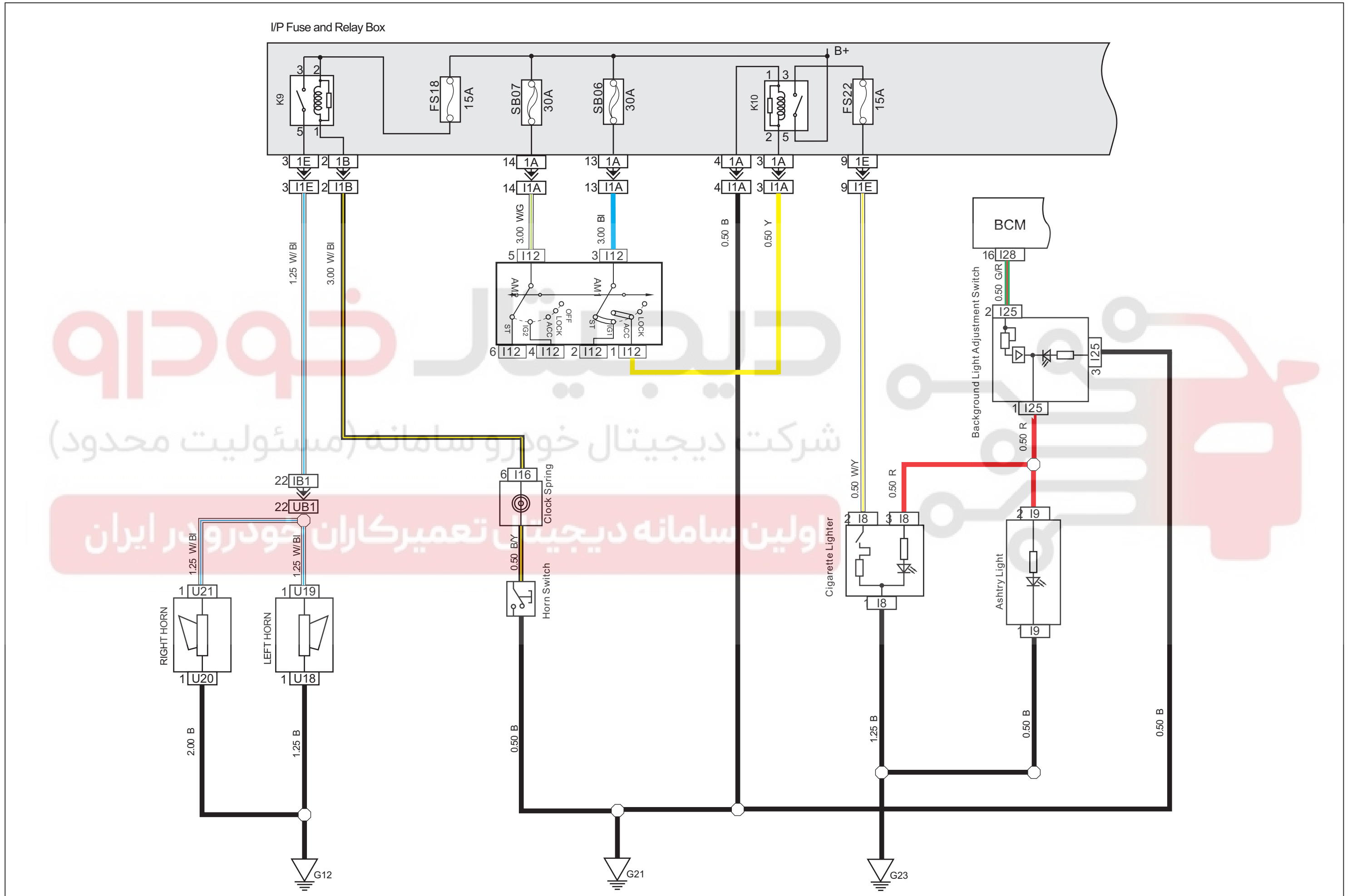

Headlamps (DX)

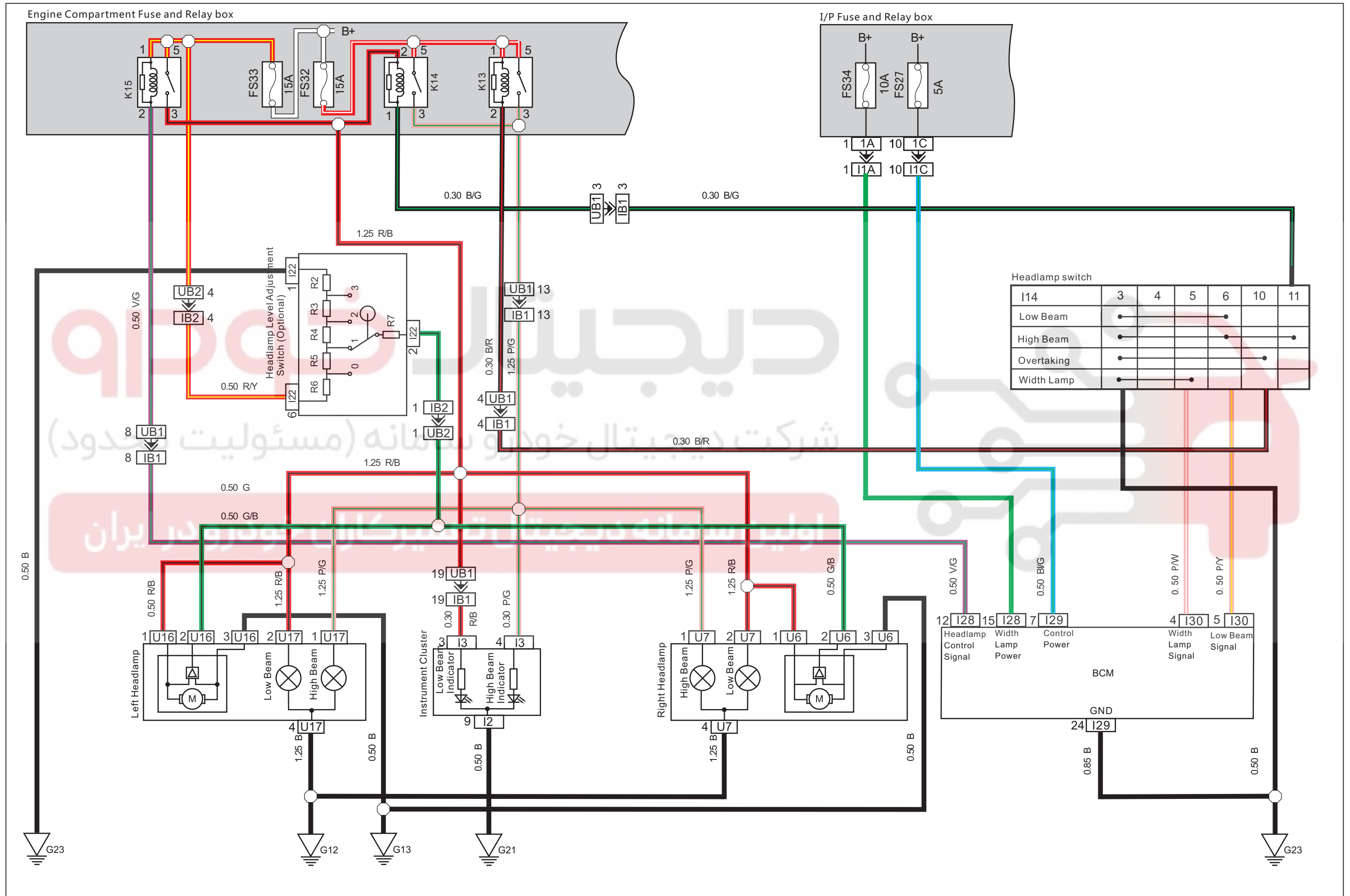

Headlamp switch

I14	3	4	5	6	10	11
Low Beam	•	•	•	•		
High Beam	•			•	•	•
Overtaking	•				•	
Width Lamp	•	•				

Headlamps (LX/EX)

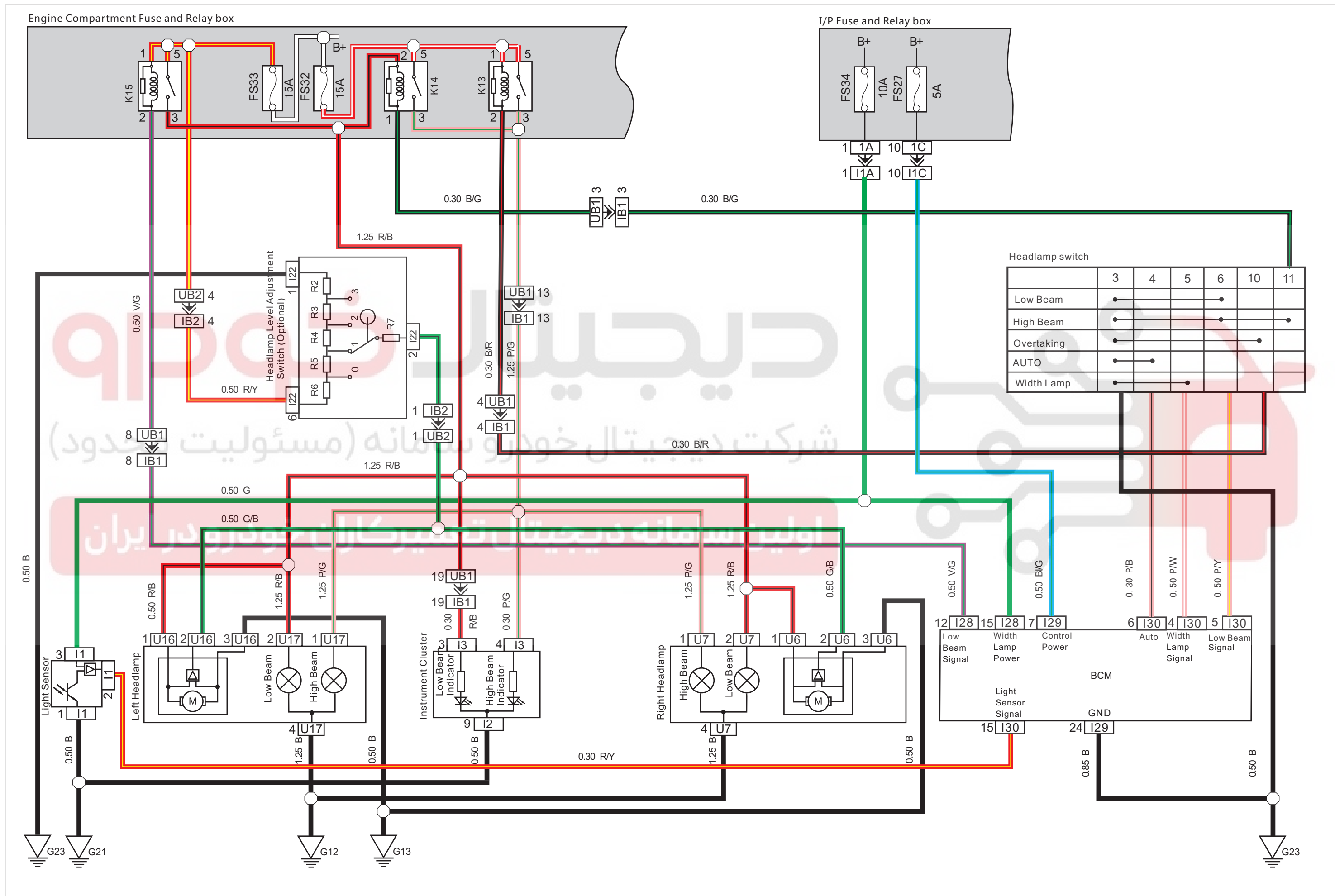

	3	4	5	6	10	11
Low Beam	•			•		
High Beam	•			•	•	•
Overtaking	•				•	
AUTO	•	•				
Width Lamp	•		•			

Front and Rear Fog Lamp

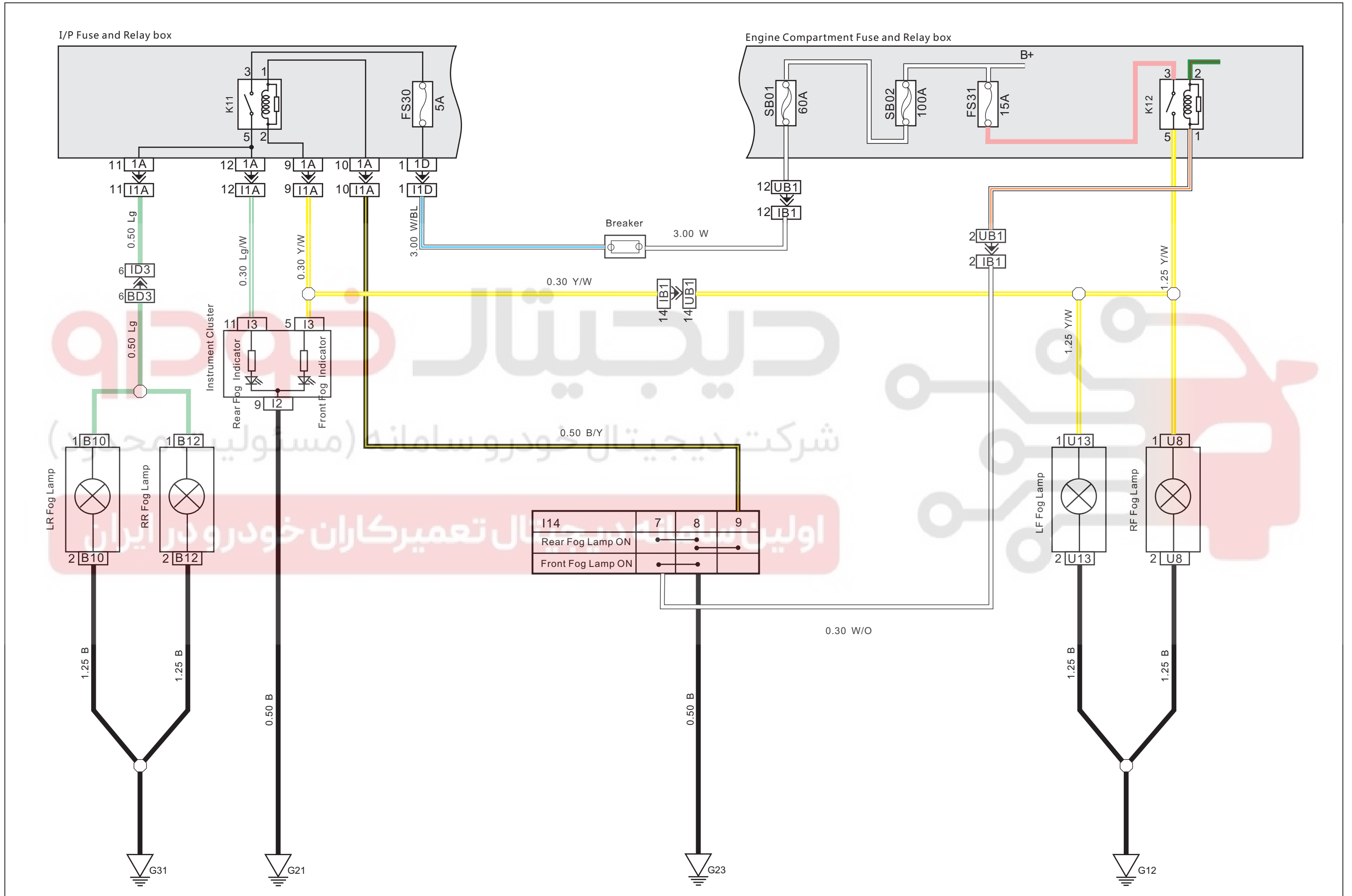

Dome Lamp/ Sunroof

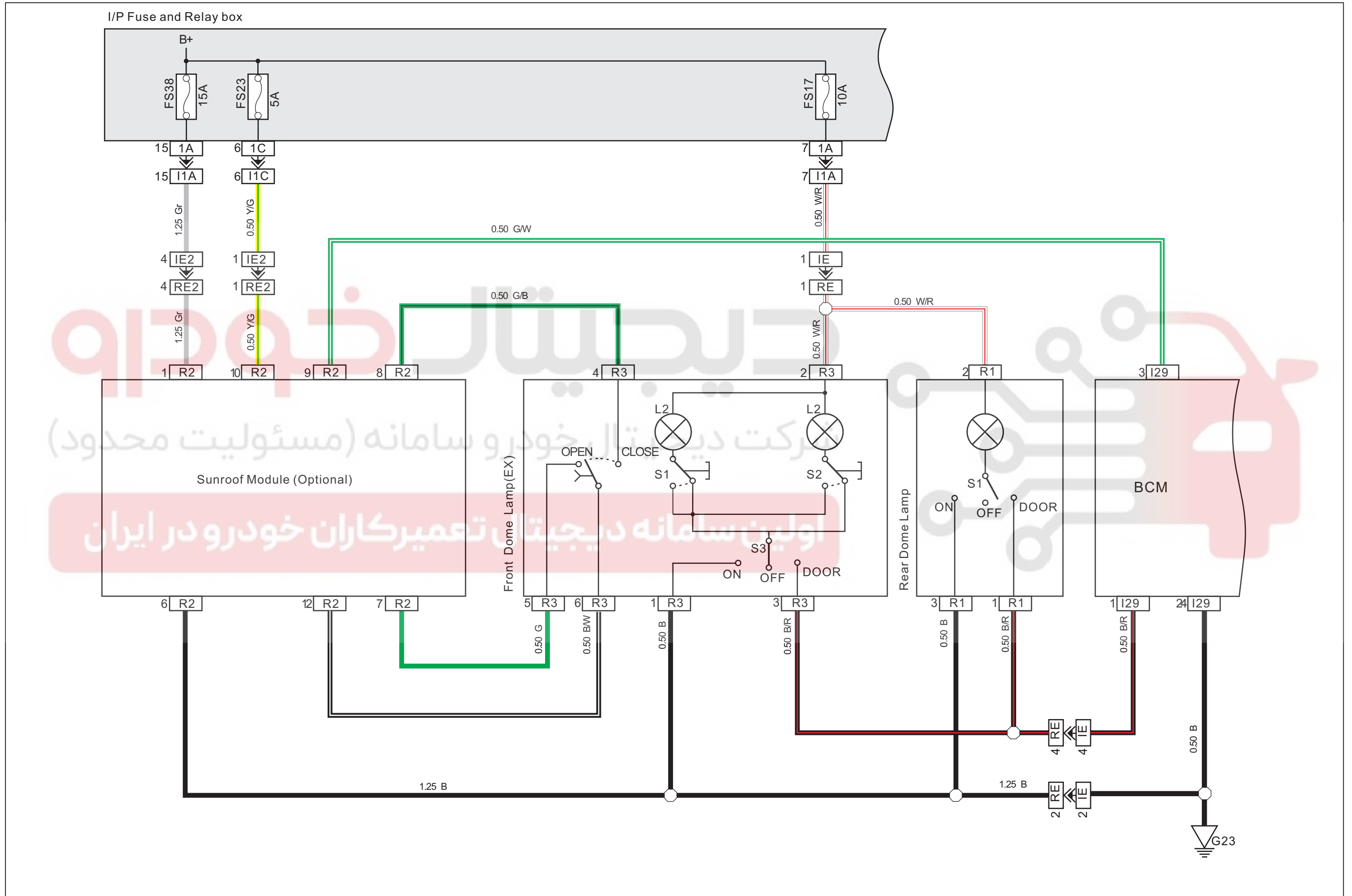

Door Lamps

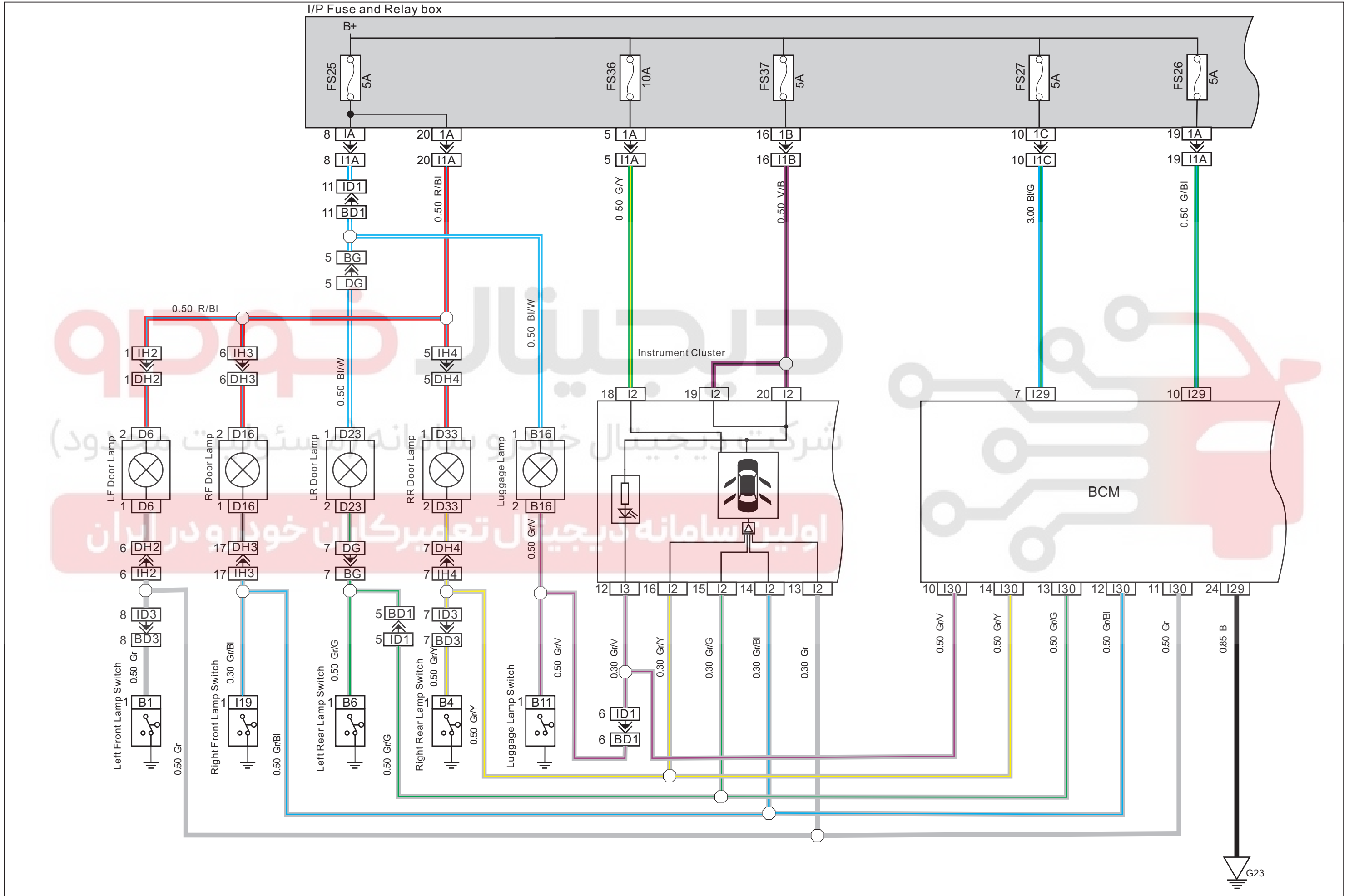

Width Lamps/Interior Lighting

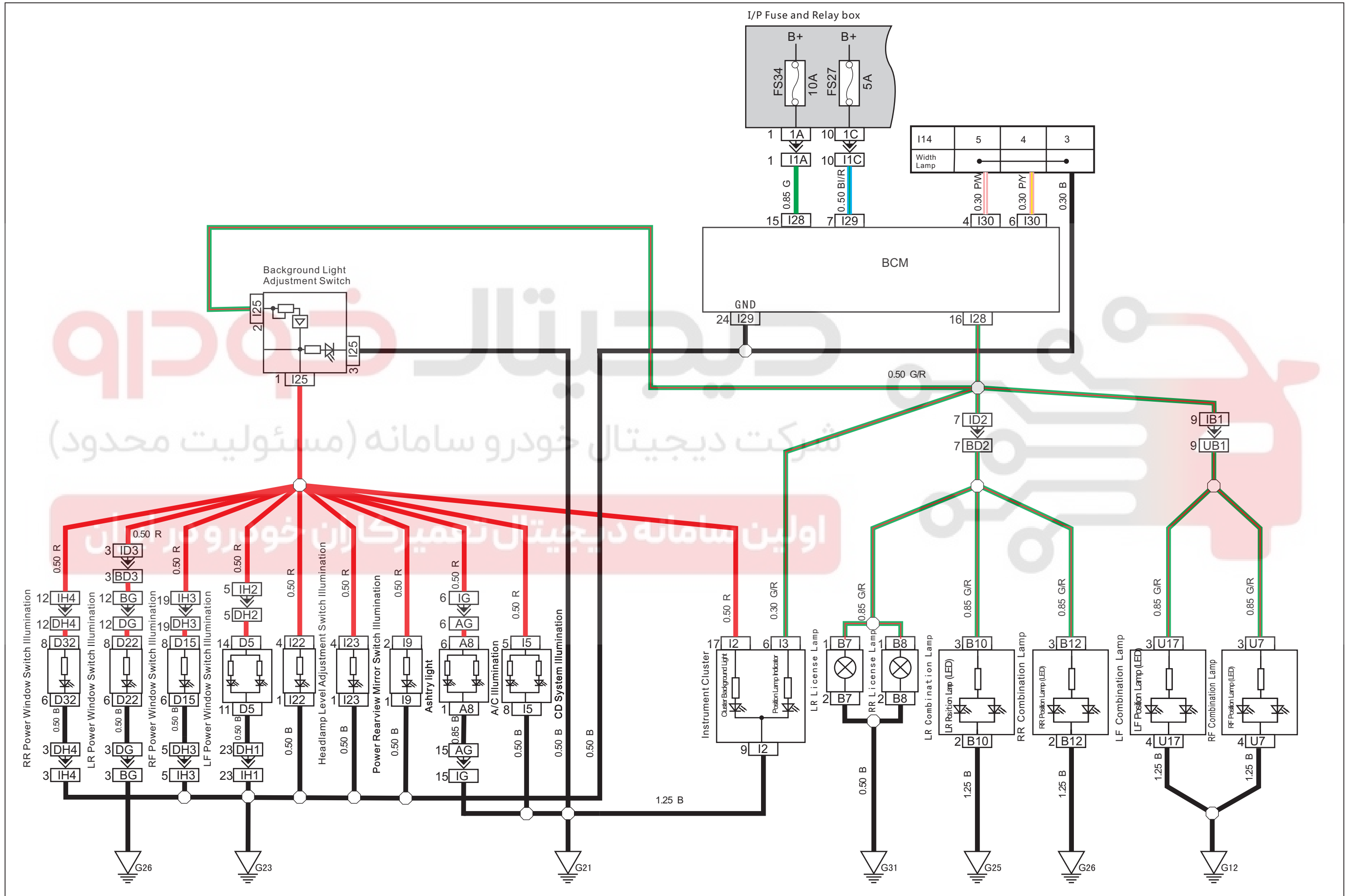

Instrument Cluster (I)

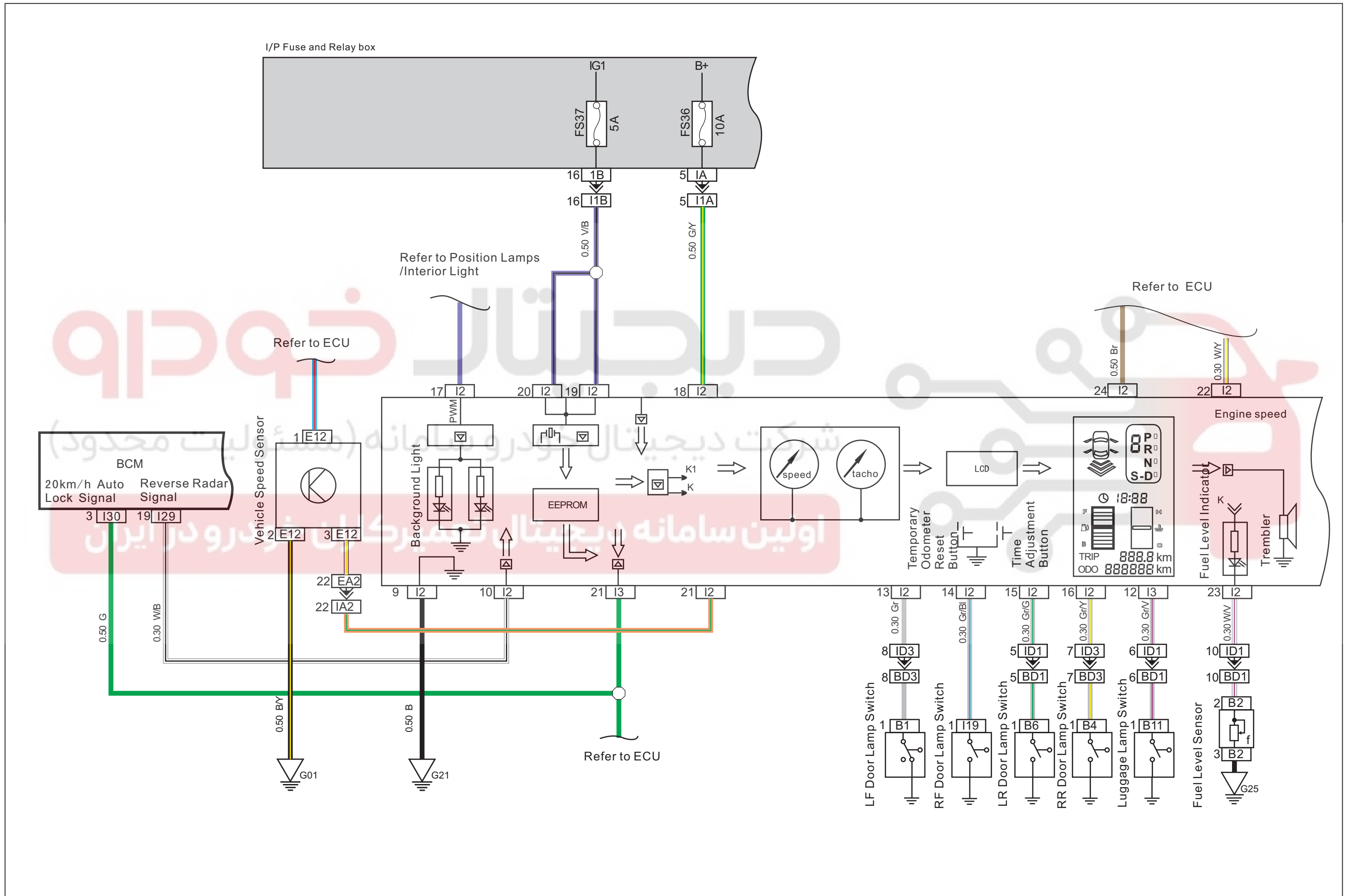

Instrument Cluster (II)

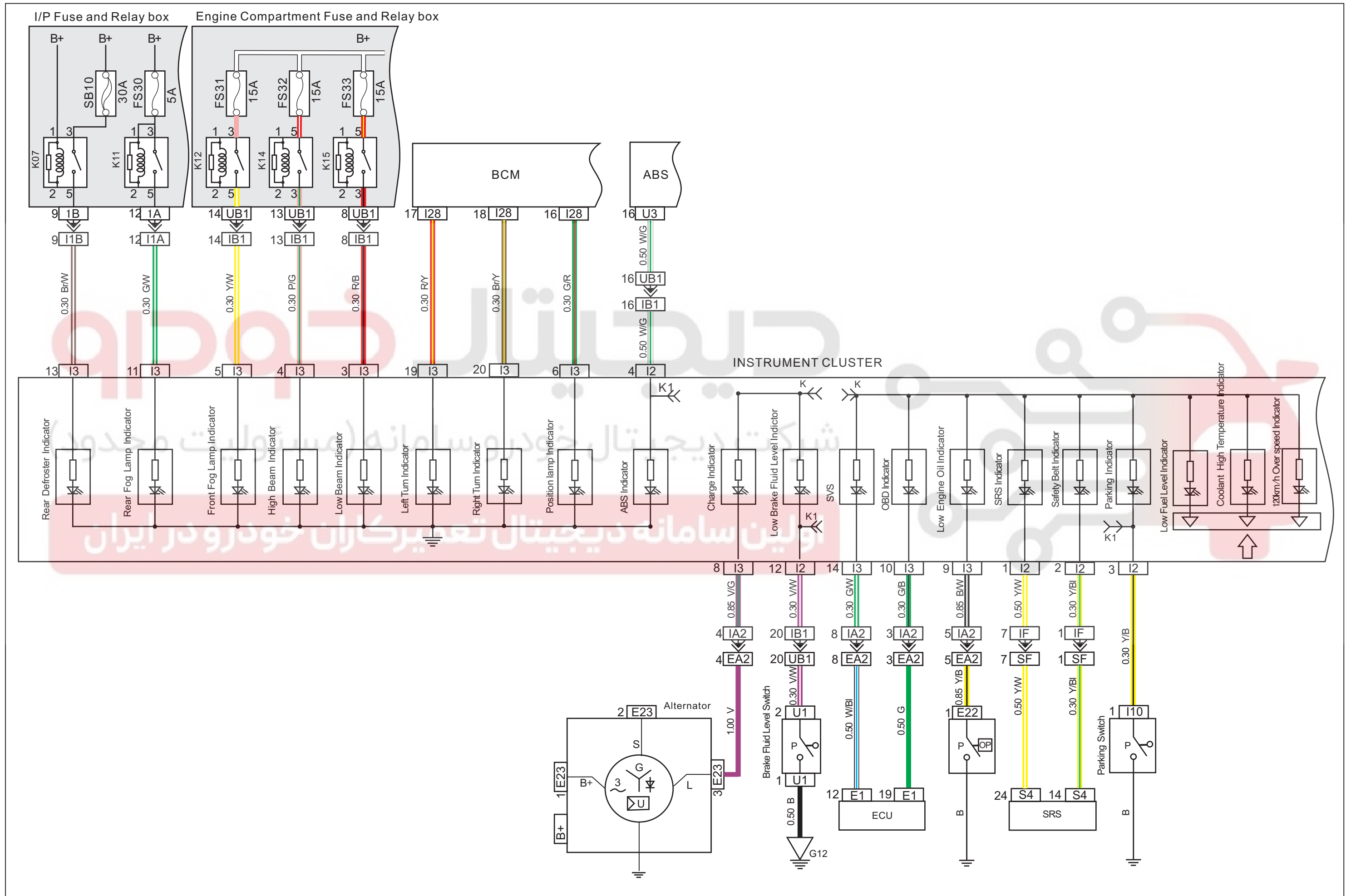

CD System

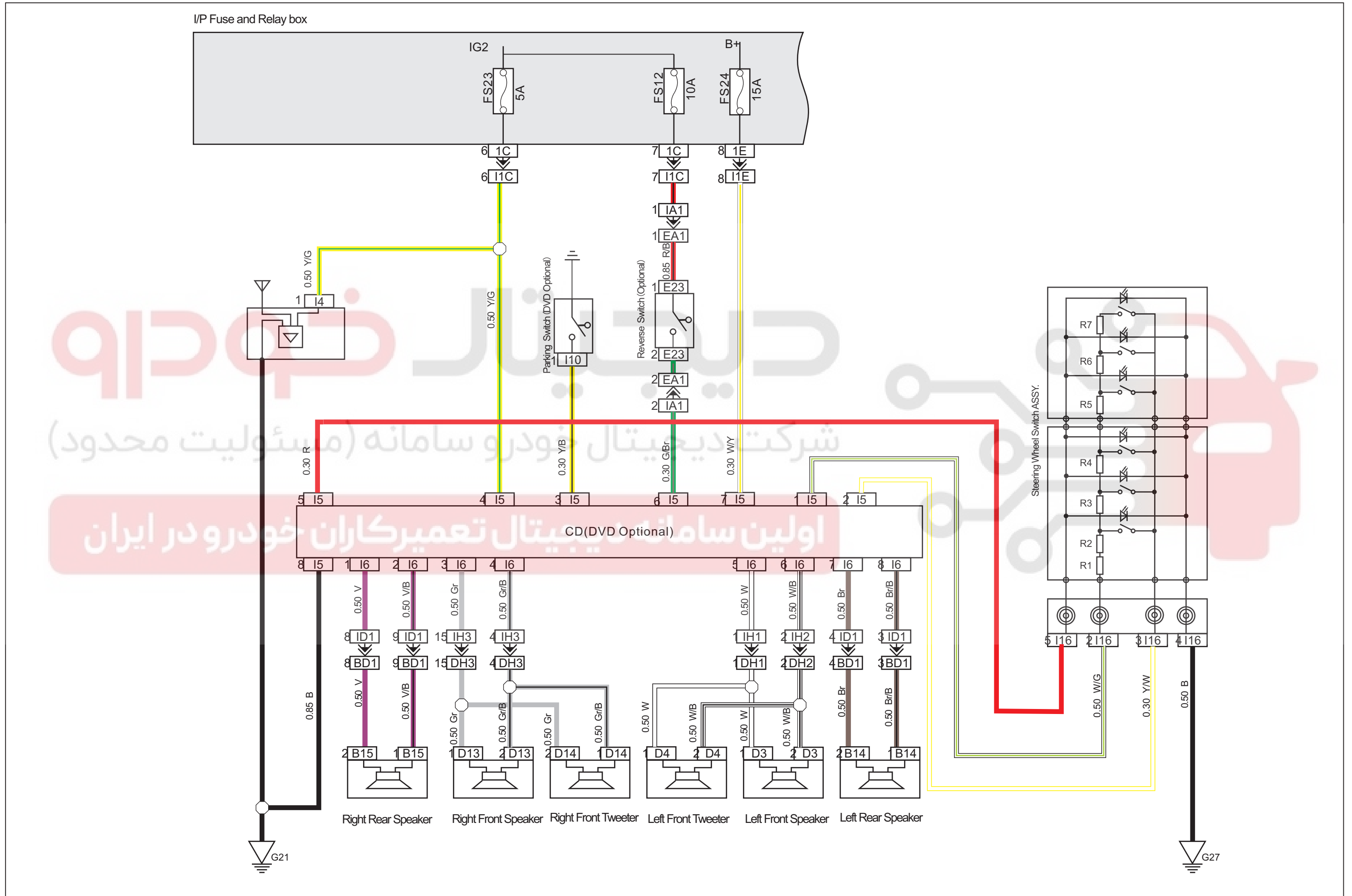

Power Window

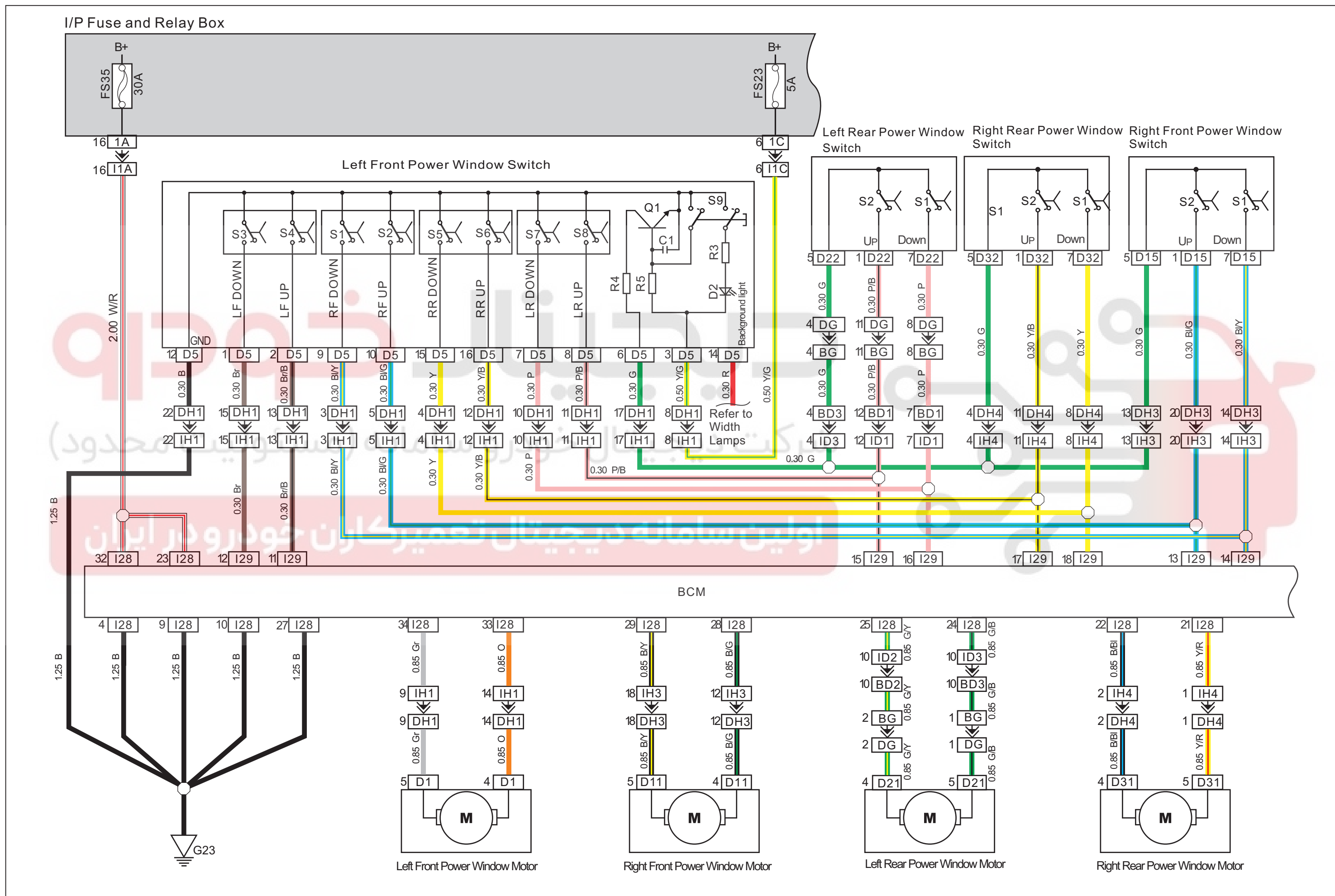

Power Rearview Mirror

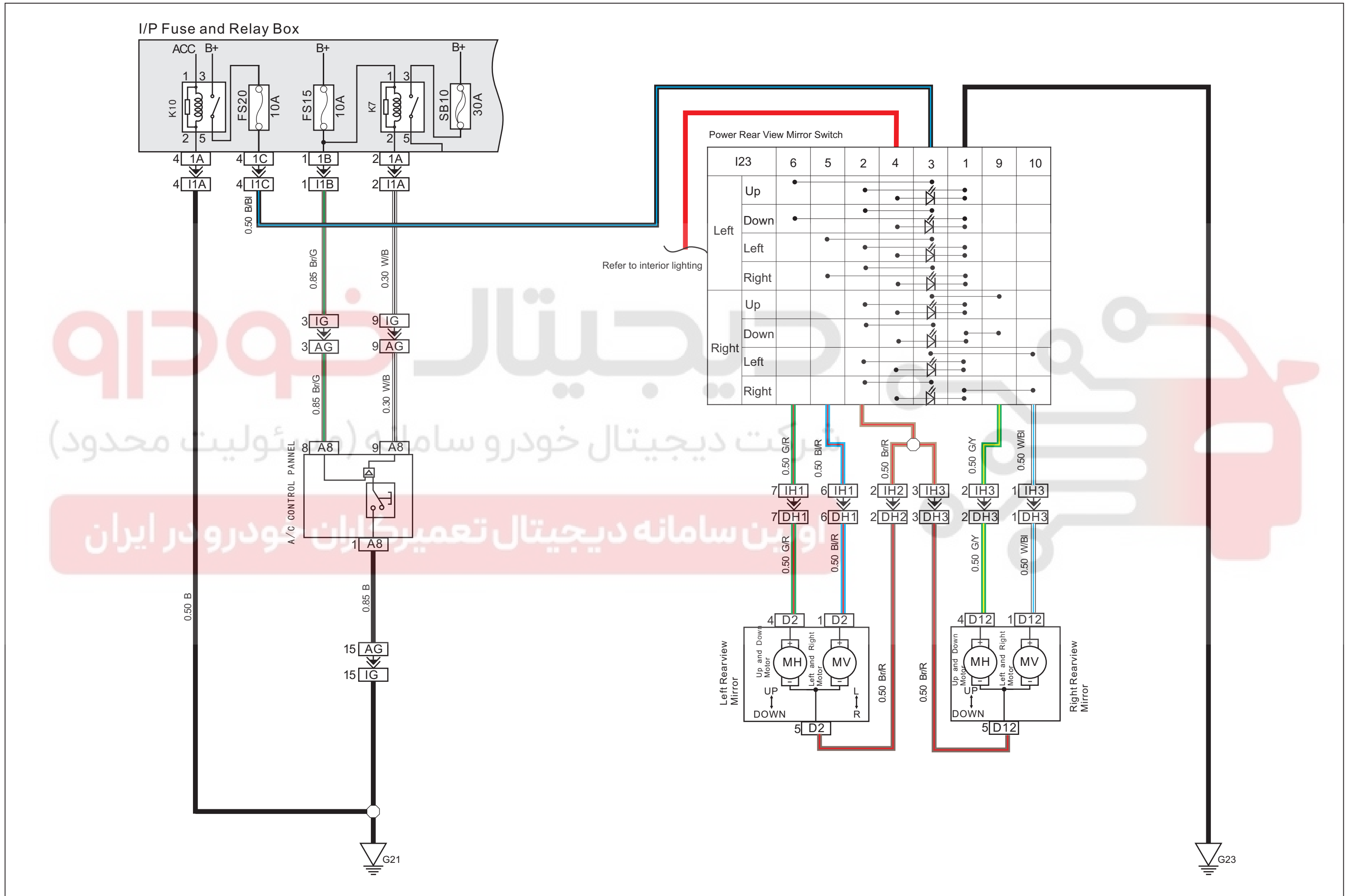

Wiper and Washer System

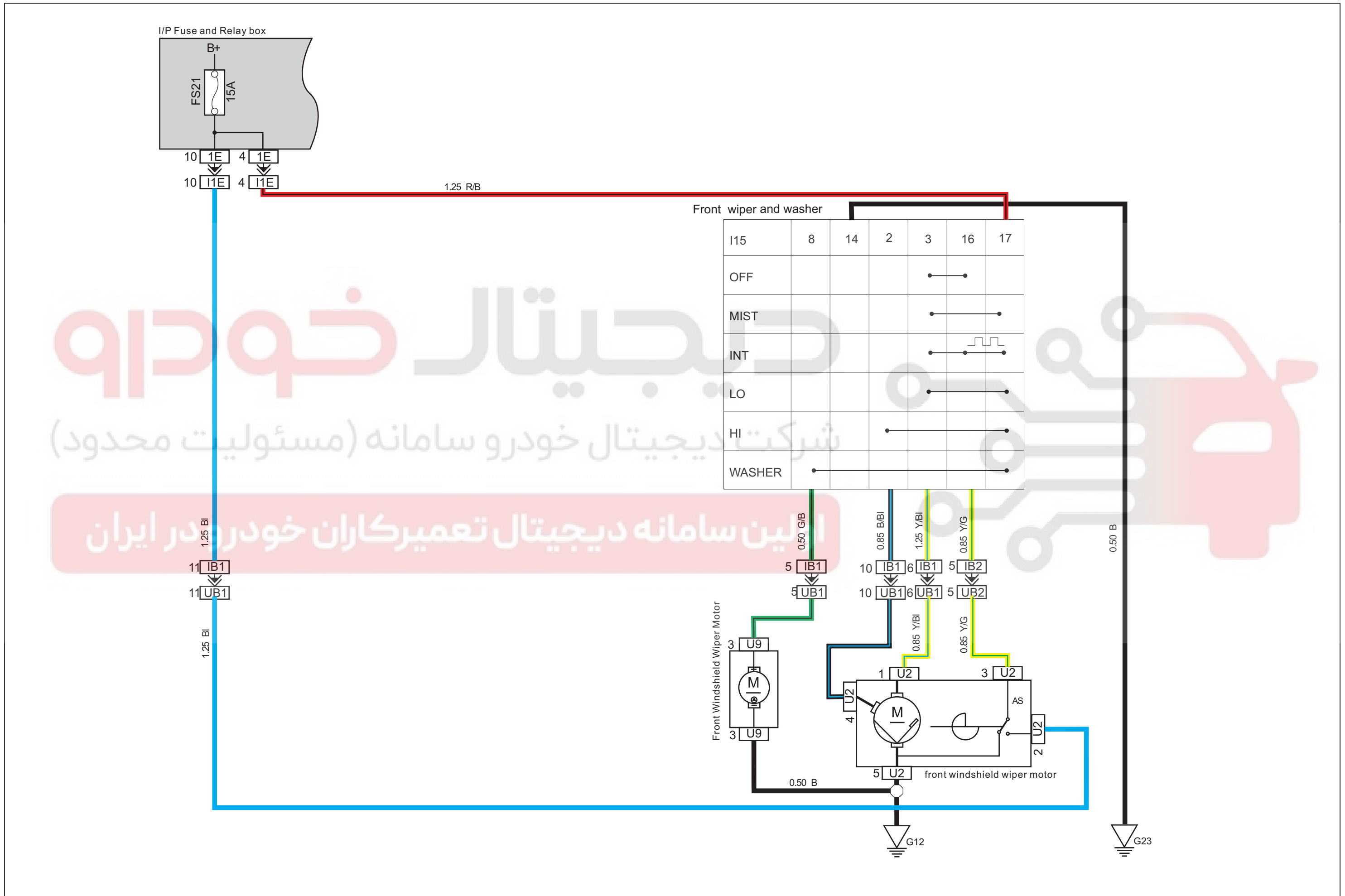

دیجیتال خودرو

شرکت دیجیتال خودرو سامانه (مسئولیت محدود)

این سامانه دیجیتال تعمیرکاران خودرو در ایران

Supplemental Restraint System

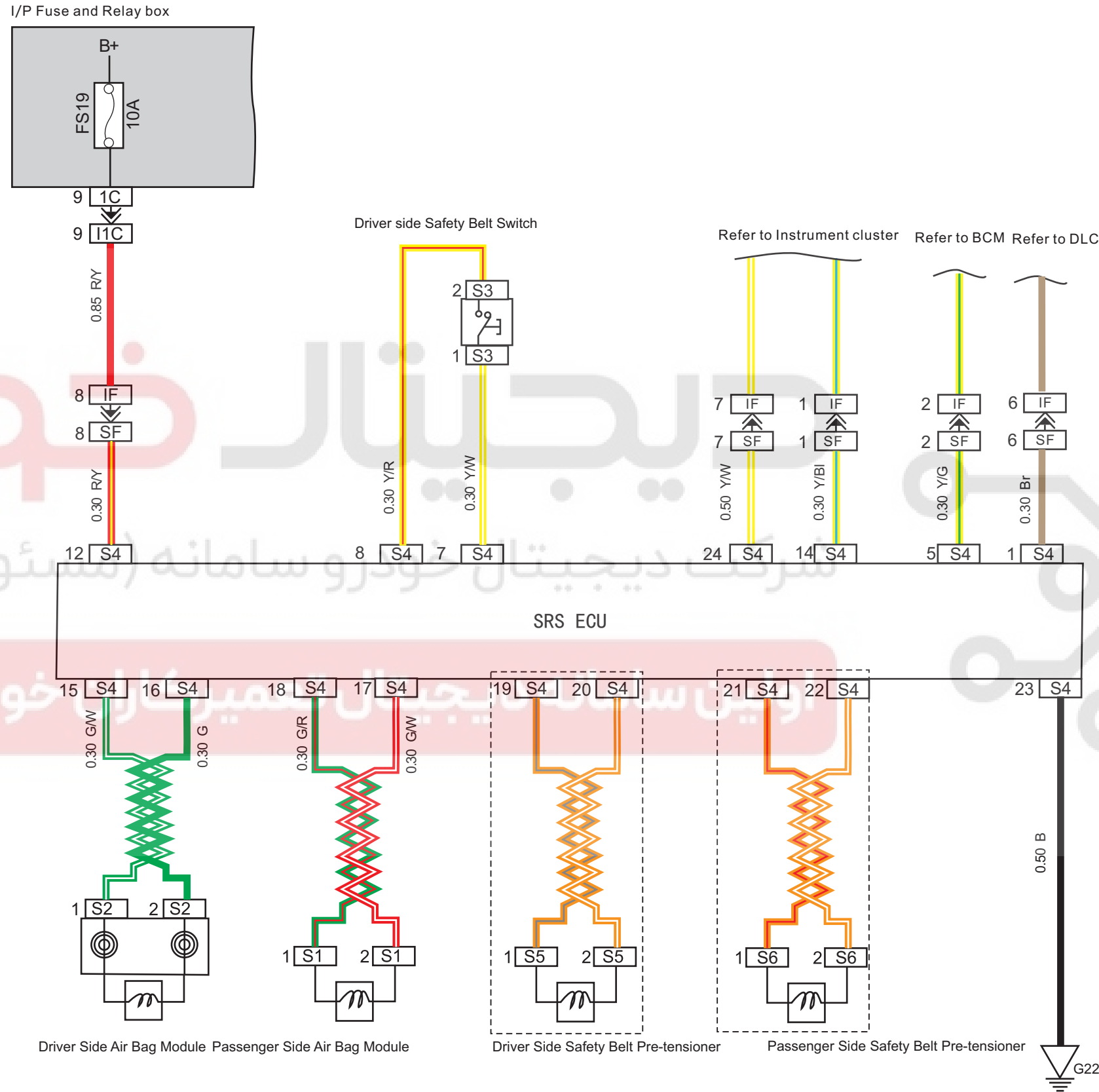

Brake lamp/Reverse Lamp/Reverse Radar System

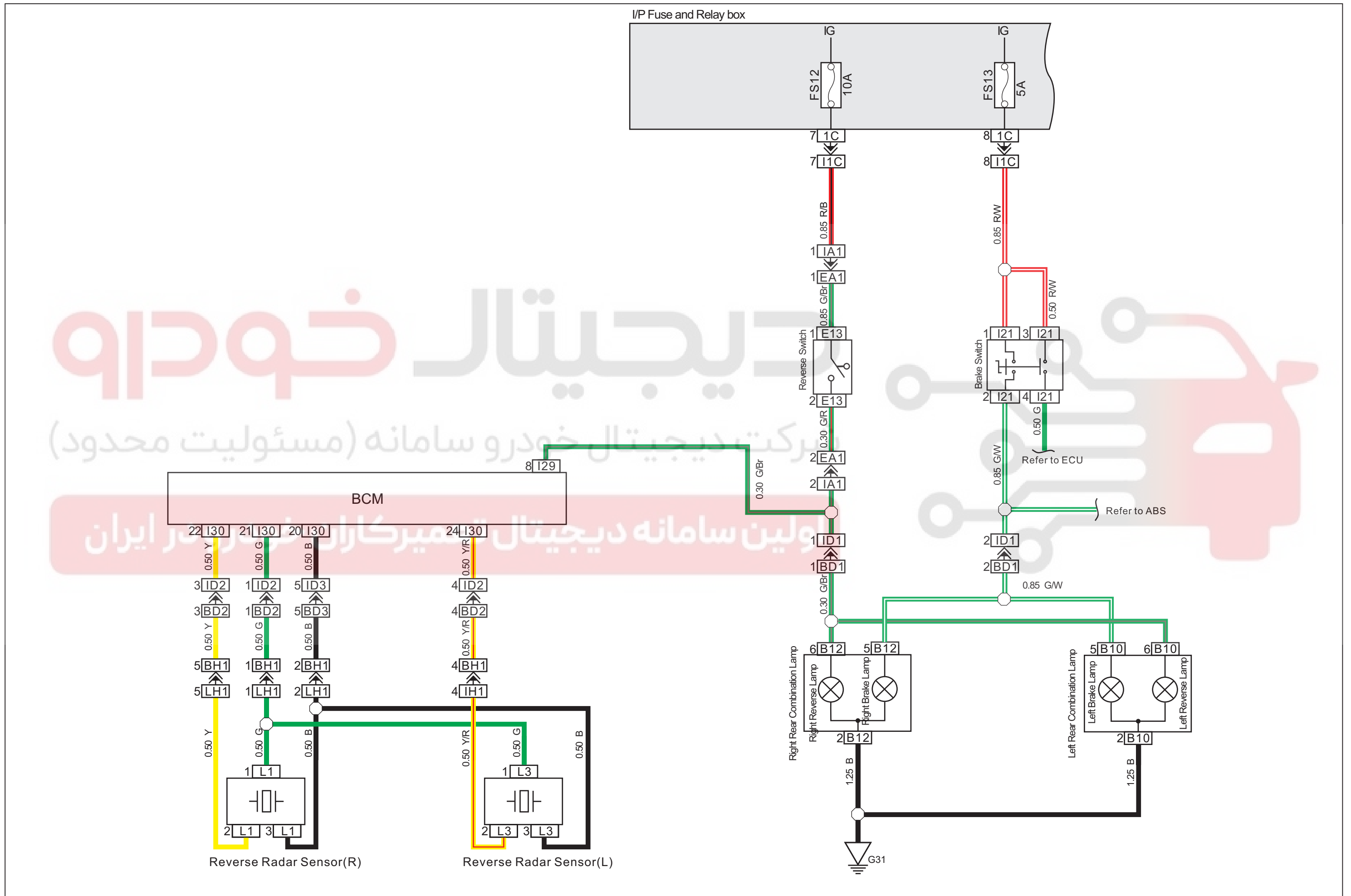

Driver's Seat Heating System (For Russian)

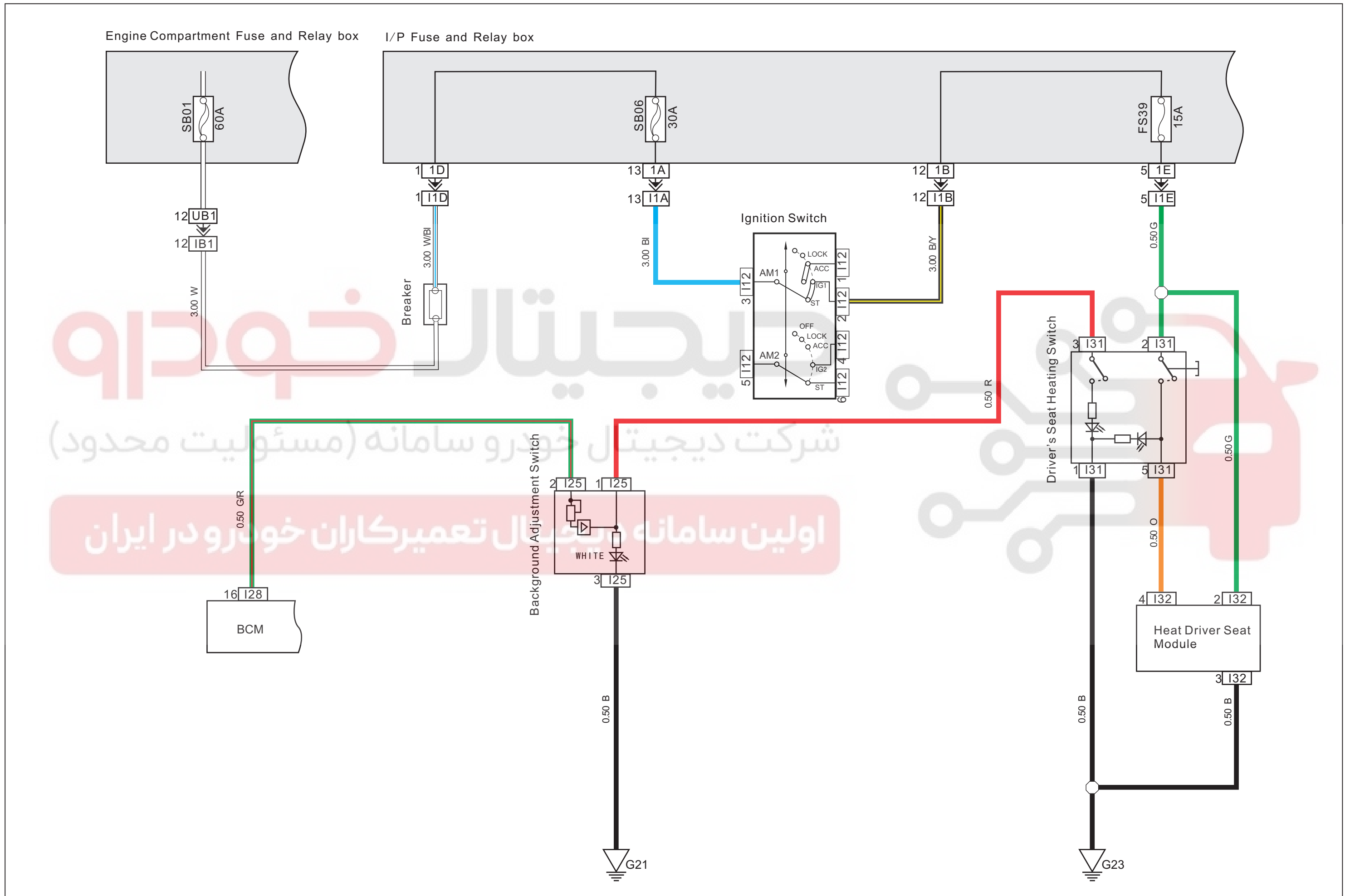

دیجیتال خودرو

شرکت دیجیتال خودرو سامانه (مسئولیت محدود)

اولین سامانه دیجیتال تعمیرکاران خودرو در ایران

ABS System

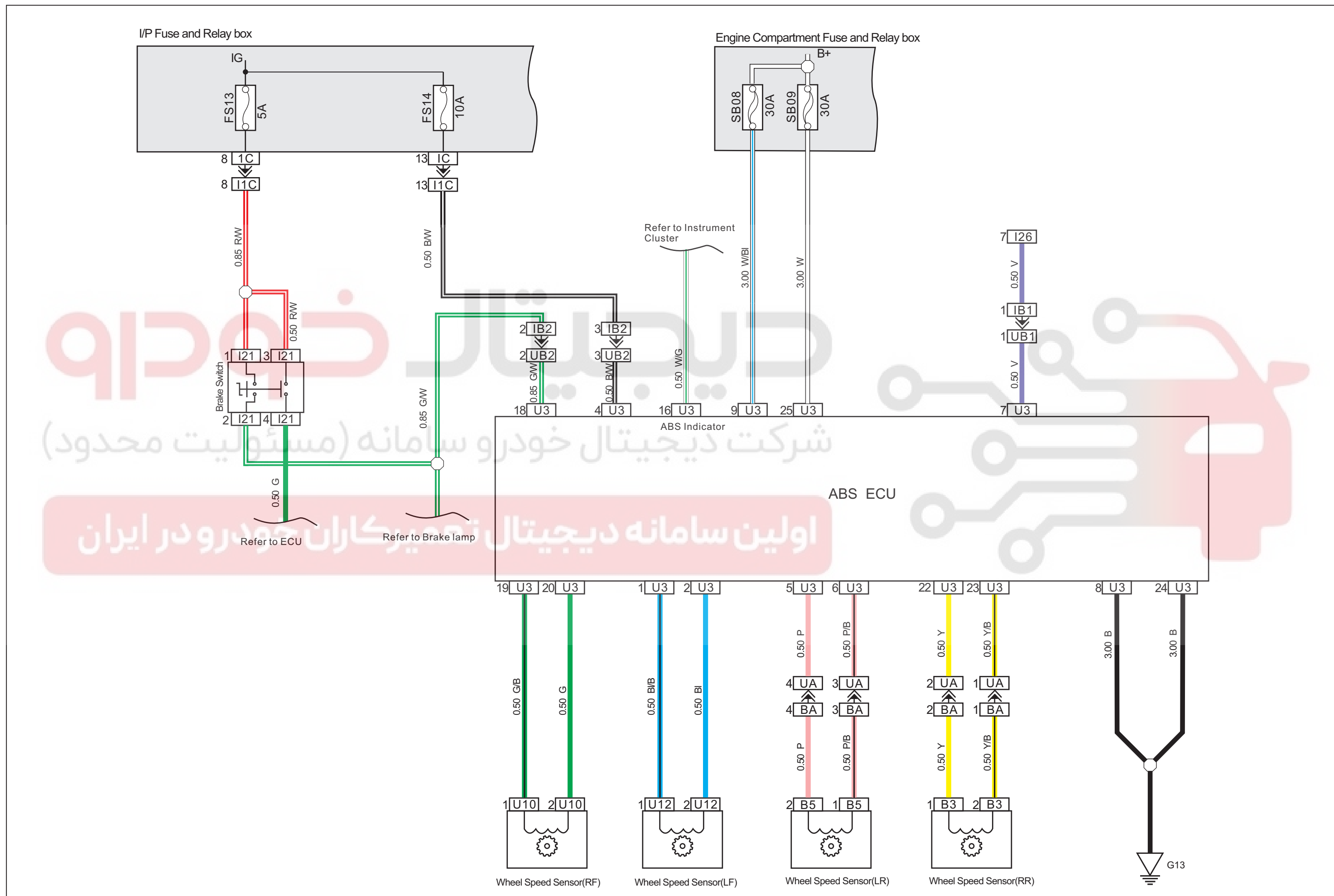

Fuse and Relay

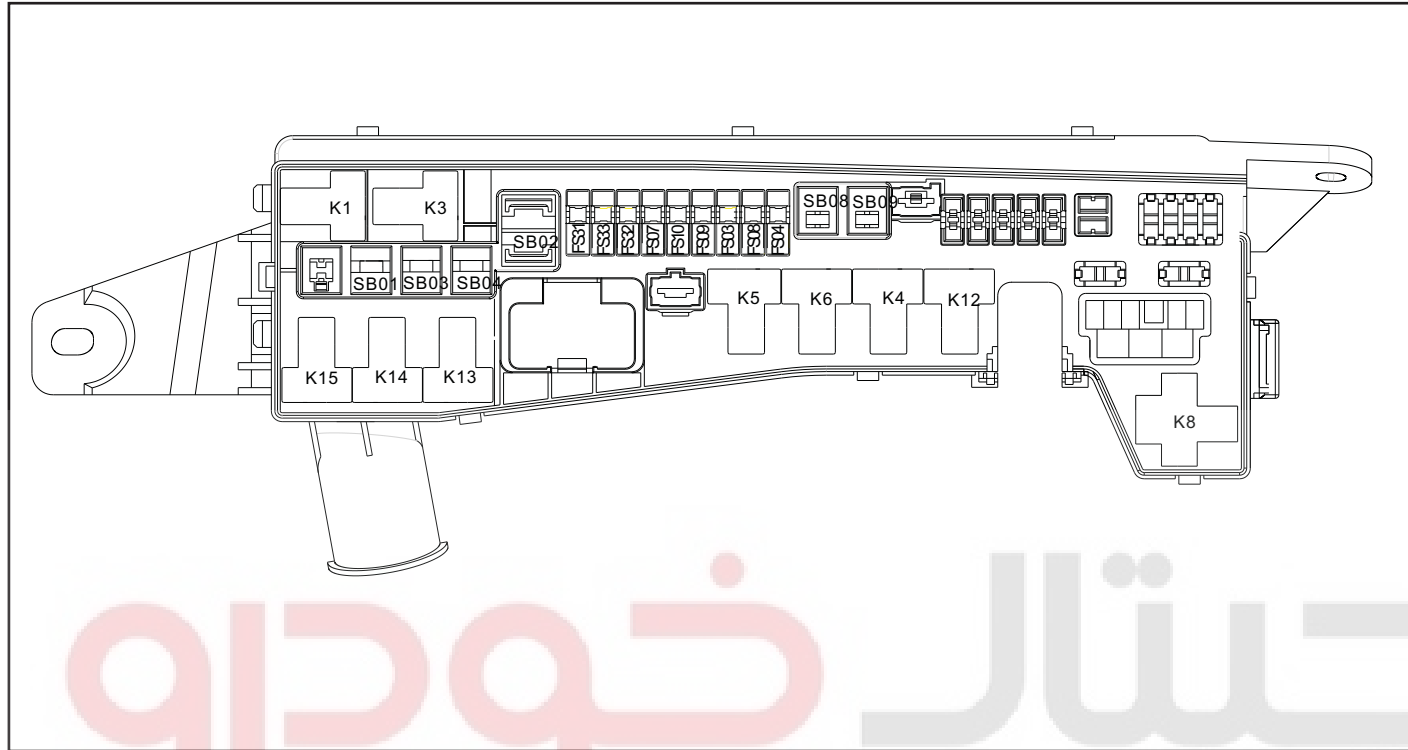

Fuse

Code	Application	Rated Current(A)	Description
SB01	Dashboard box	60	
SB02	B Terminal	100	
SB03	ACCY PWR	60	
SB04	Blower	40	
SB08	ABS	30	
SB09	ABS	30	
FS03	Engine ECU	10	
FS04	Main Relay	25	
FS07	Control Fan	5	
FS08	ACC	10	
FS09	HI_SPD Fan	35	
FS10	LW_SPD Fan	35	
FS31	FR Fog	15	
FS32	HI Beam	15	
FS33	LW Beam	15	

Relay

Code	Application	description
K1	Main relay	
K3	ACC	
K4	Hi-speed relay	
K5	Speed regulation	
K6	Fan Low Speed	
K8	Blower	
K12	FR fog	
K13	Overtaking Lamp	
K14	High Beam	
K15	Low Beam	

Fuse and Relay

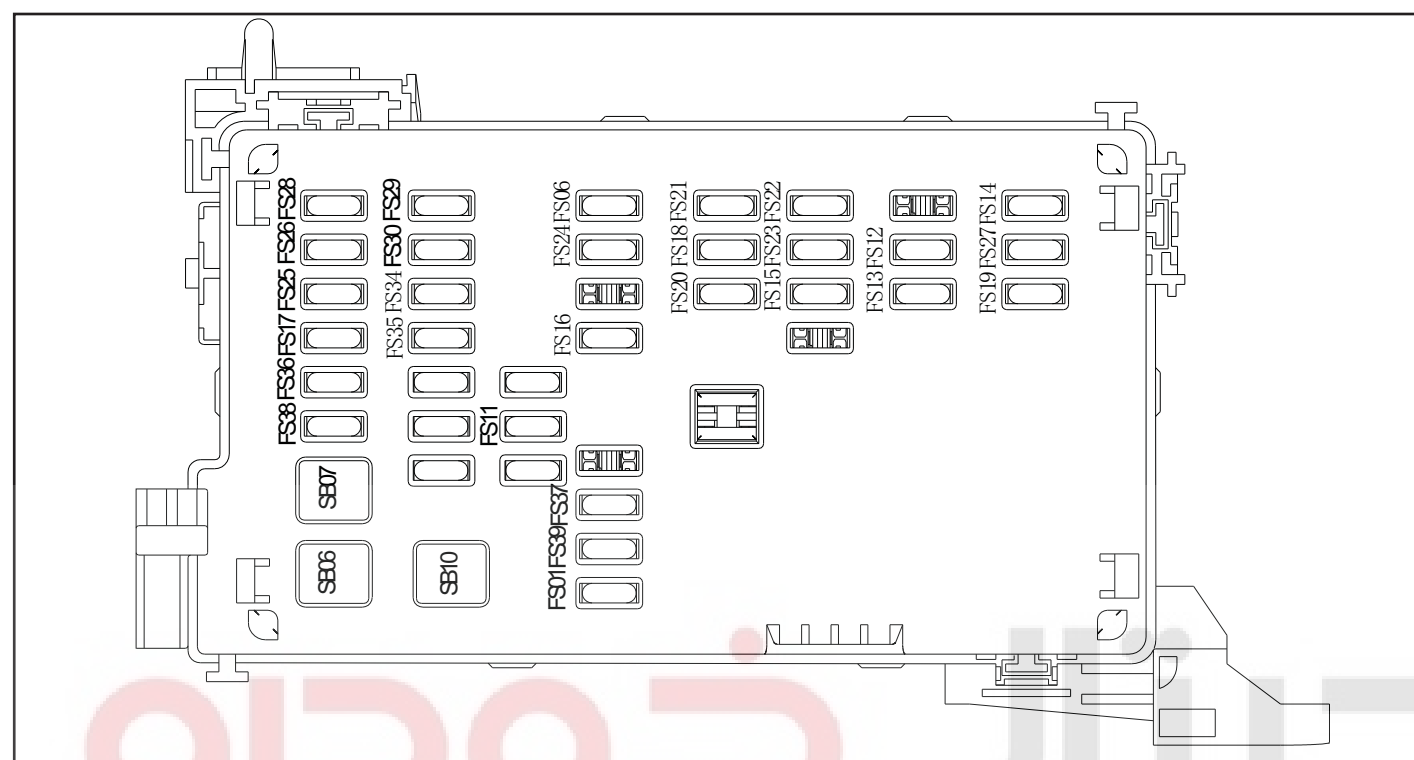

Fuse

Code	Application	Rated Current(A)	description
FS24	V/A Power/Diagnostic	15	
FS25	Door lamp/LUG lamp	5	
FS26	BCM power B+	5	
FS27	BCM control	5	
FS28	Concentrated control lock power	10	
FS29	Turn lamp/Hazard lamp	15	
FS30	RR fog	5	
FS34	Position lamp	10	
FS35	Power window	30	
FS36	COMB. instrument B+	10	
FS37	COMB. Instrument IGN/Diagnostic	5	
FS38	Sunroof power	15	
FS39	Driver seat heater	15	



Ground Distribution

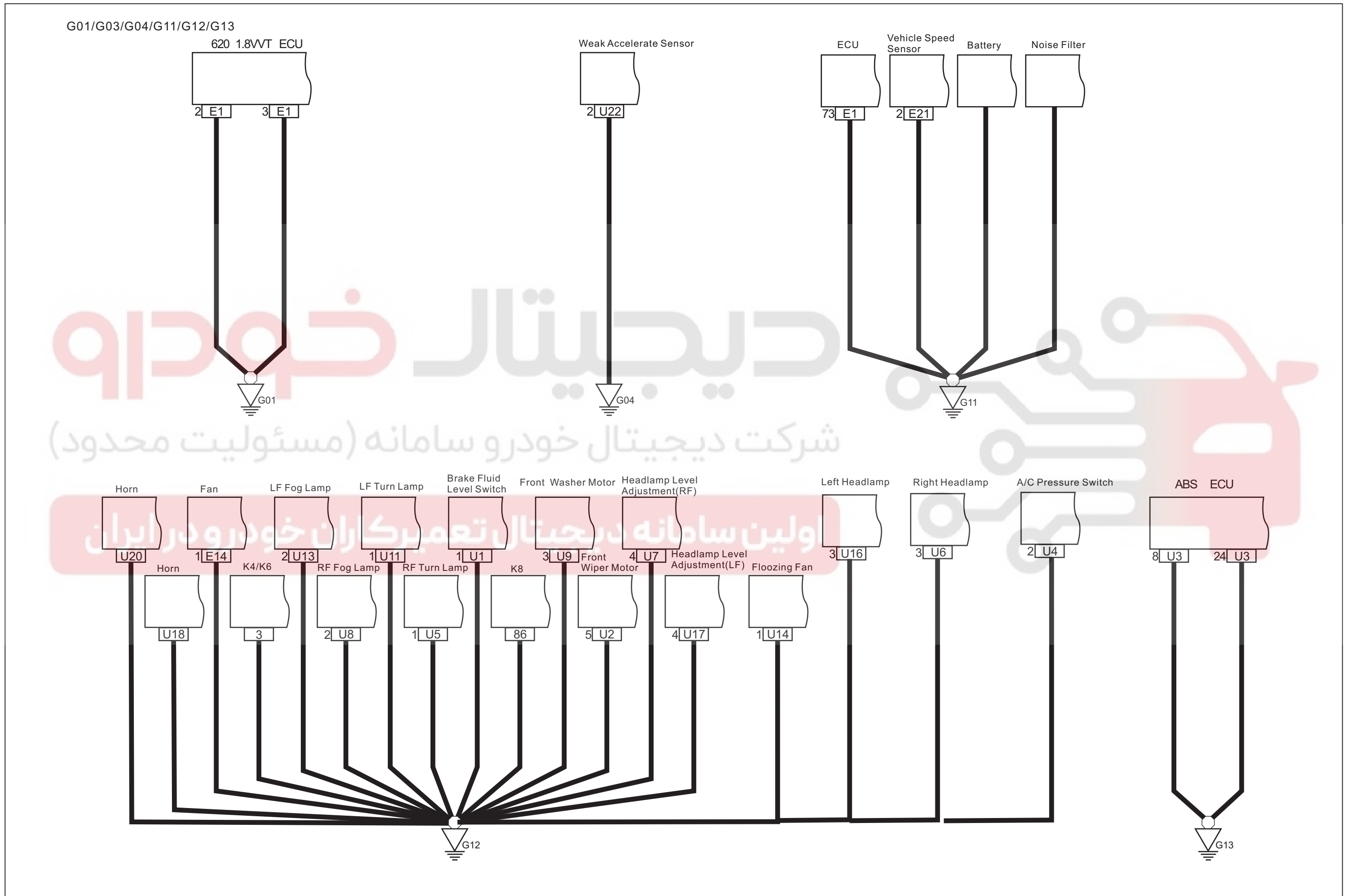

Ground Distribution

G21/G23

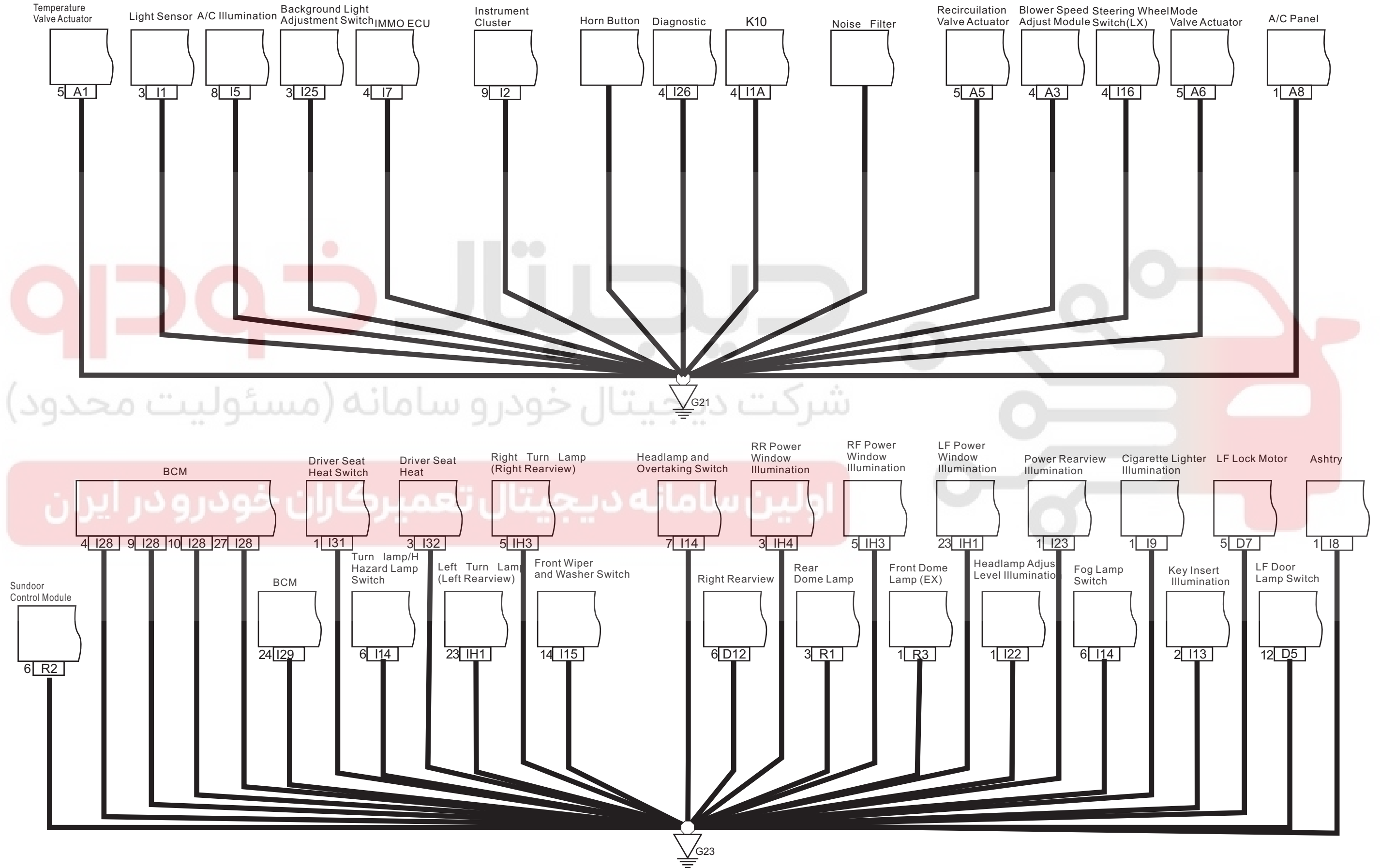

شرکت دیجیتال خودرو (مسئولیت محدود)

اولین سامانه دیجیتال تعمیرکاران خودرو در ایران

Ground Distribution

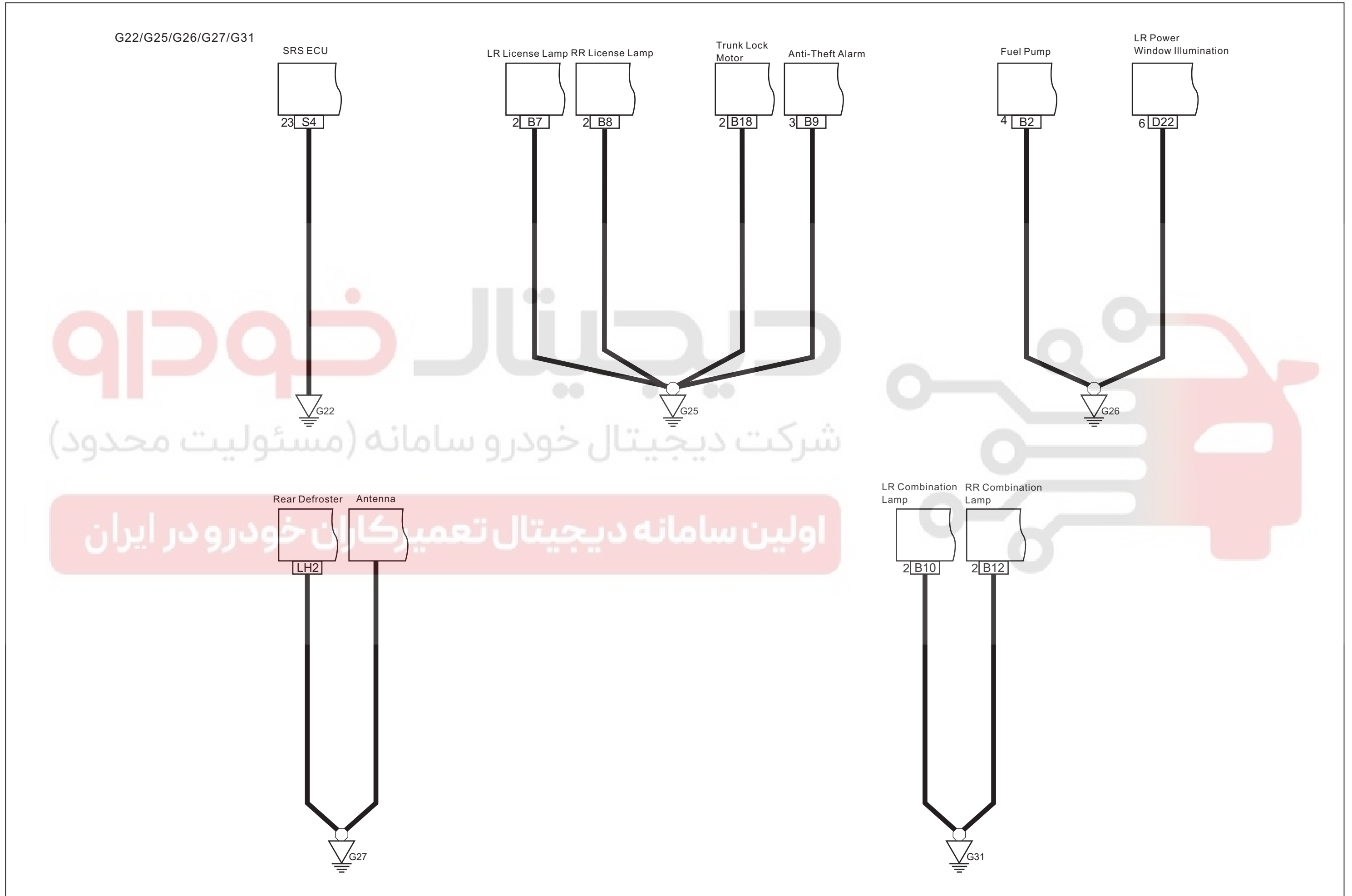

Harness Connector Location View

Engine Harness Connector Location View

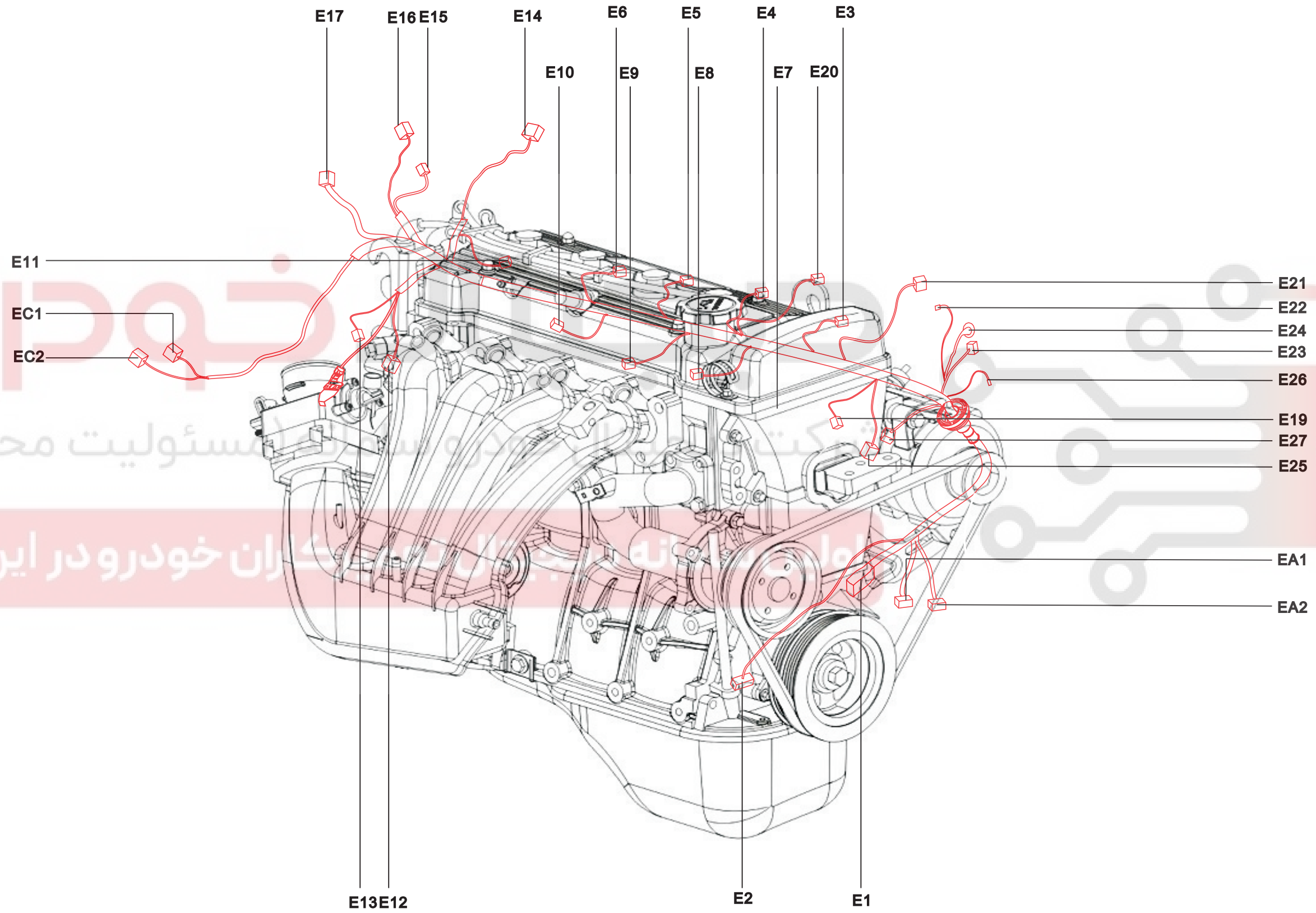

Harness Connector Location View

Engine compartment Harness Connector Location View

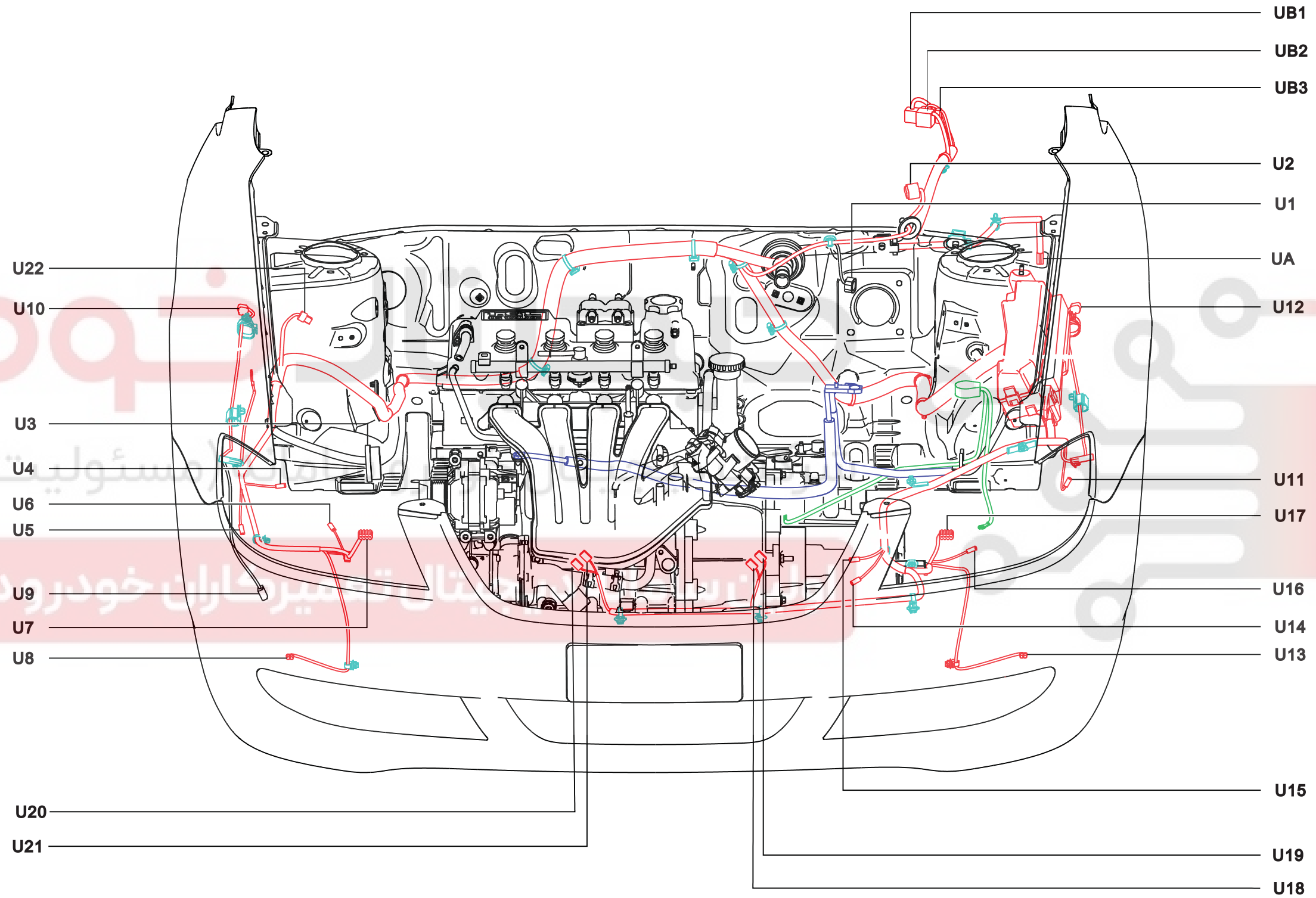

Harness Connector Location View

I/P Harness Connector Location View

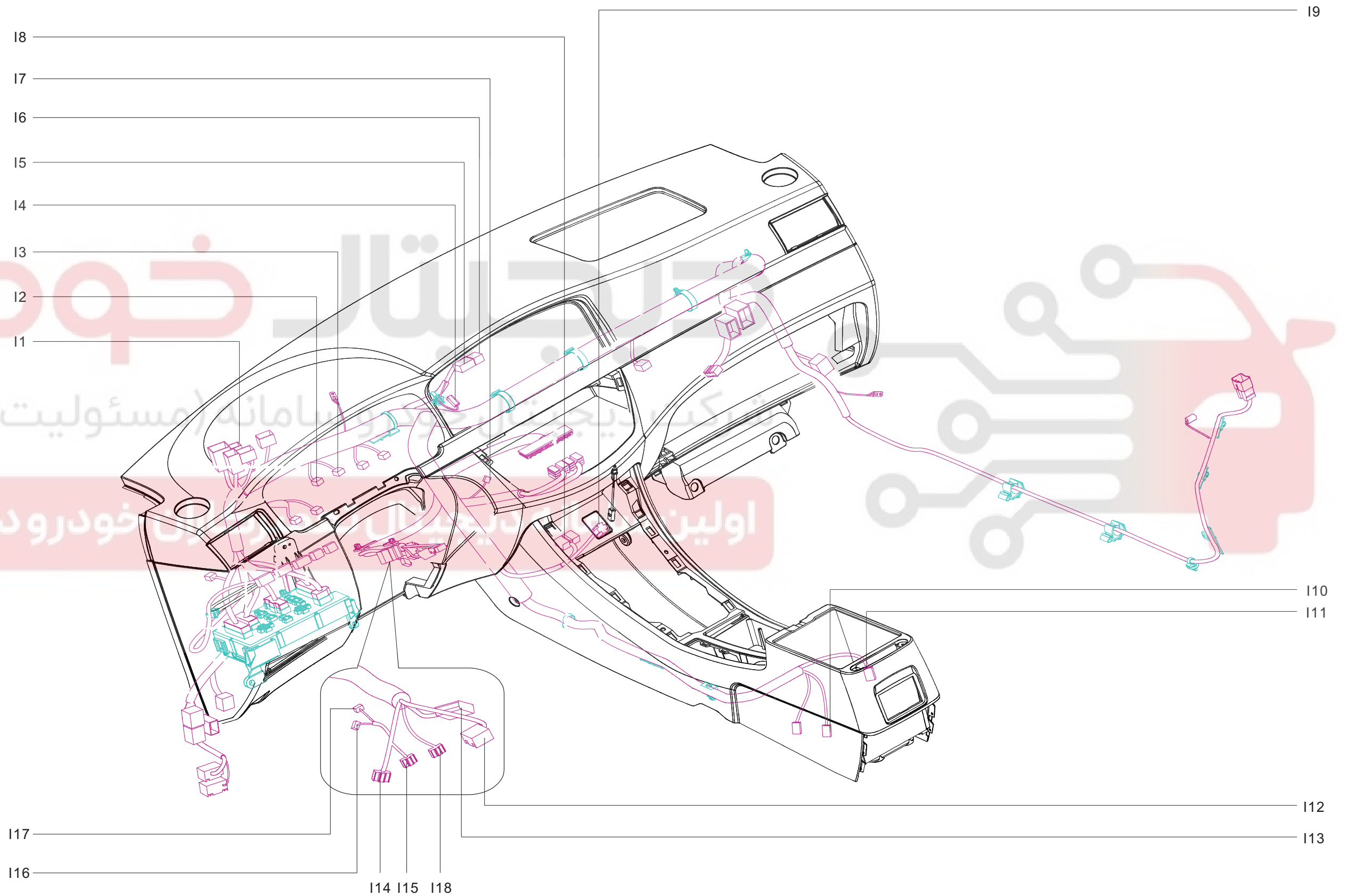

Harness Connector Location View

I/P Harness Connector Location View

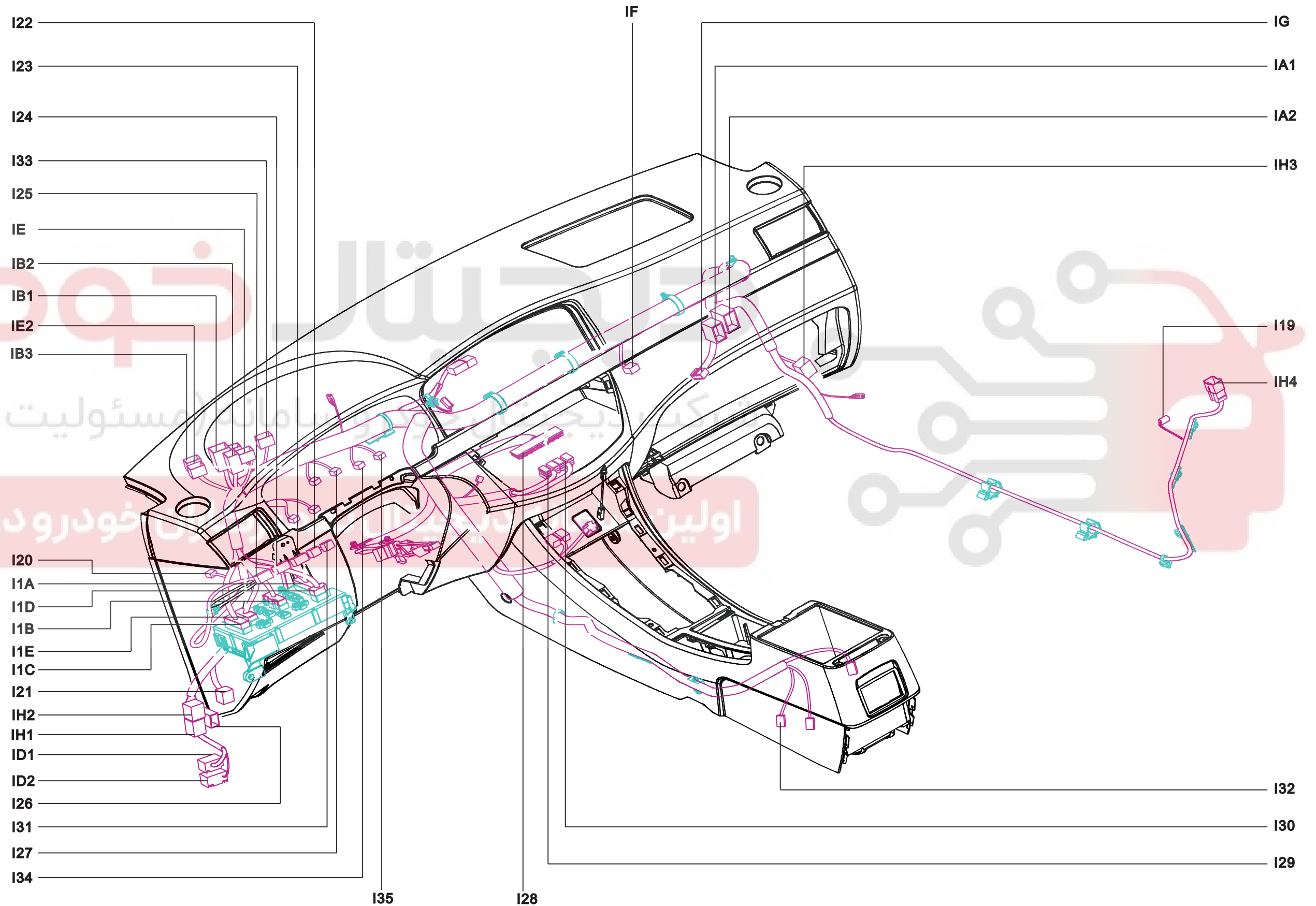

Harness Connector Location View

Body Harness Connector Location View

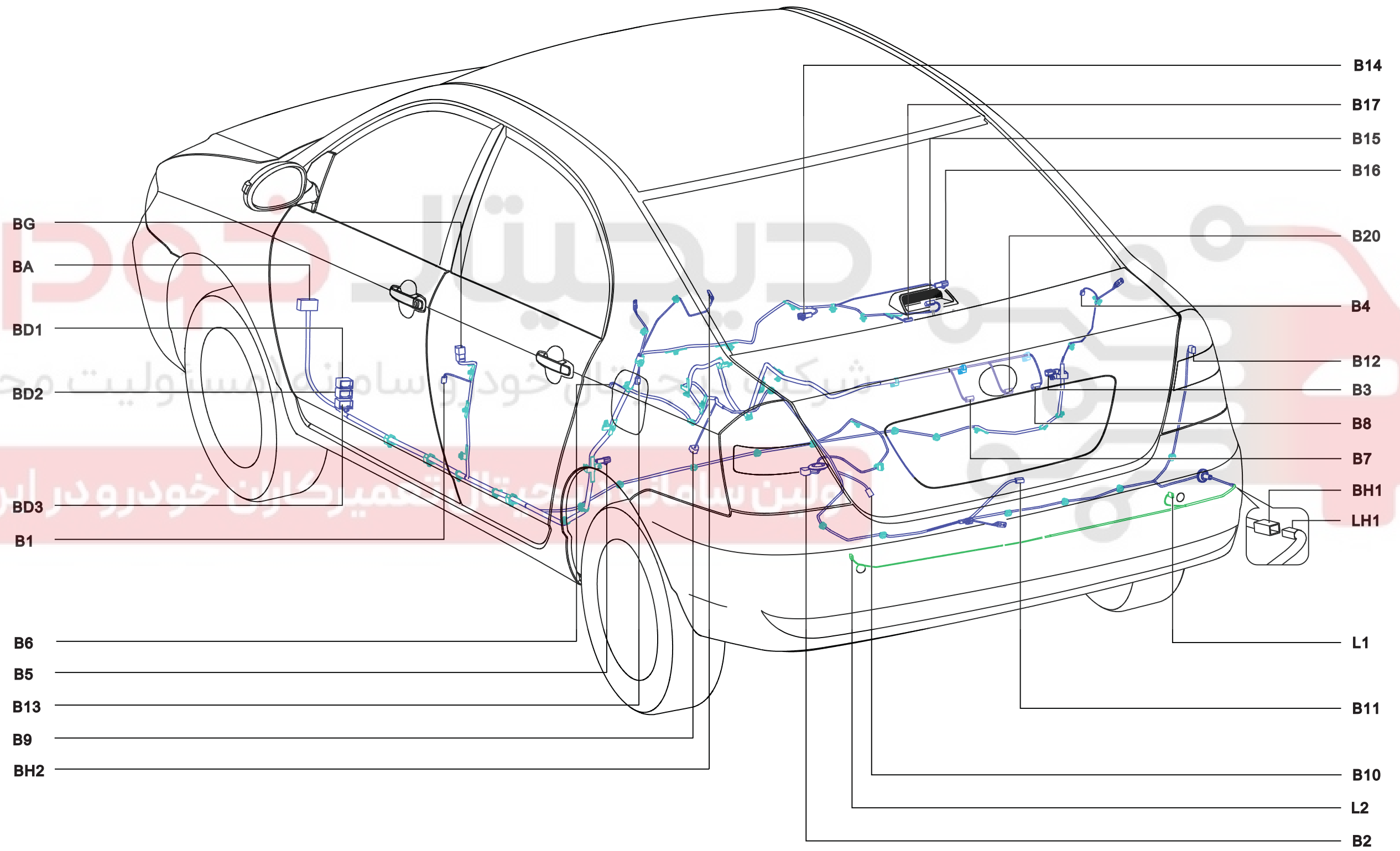

Harness Connector Location View

Door Harness Connector Location View

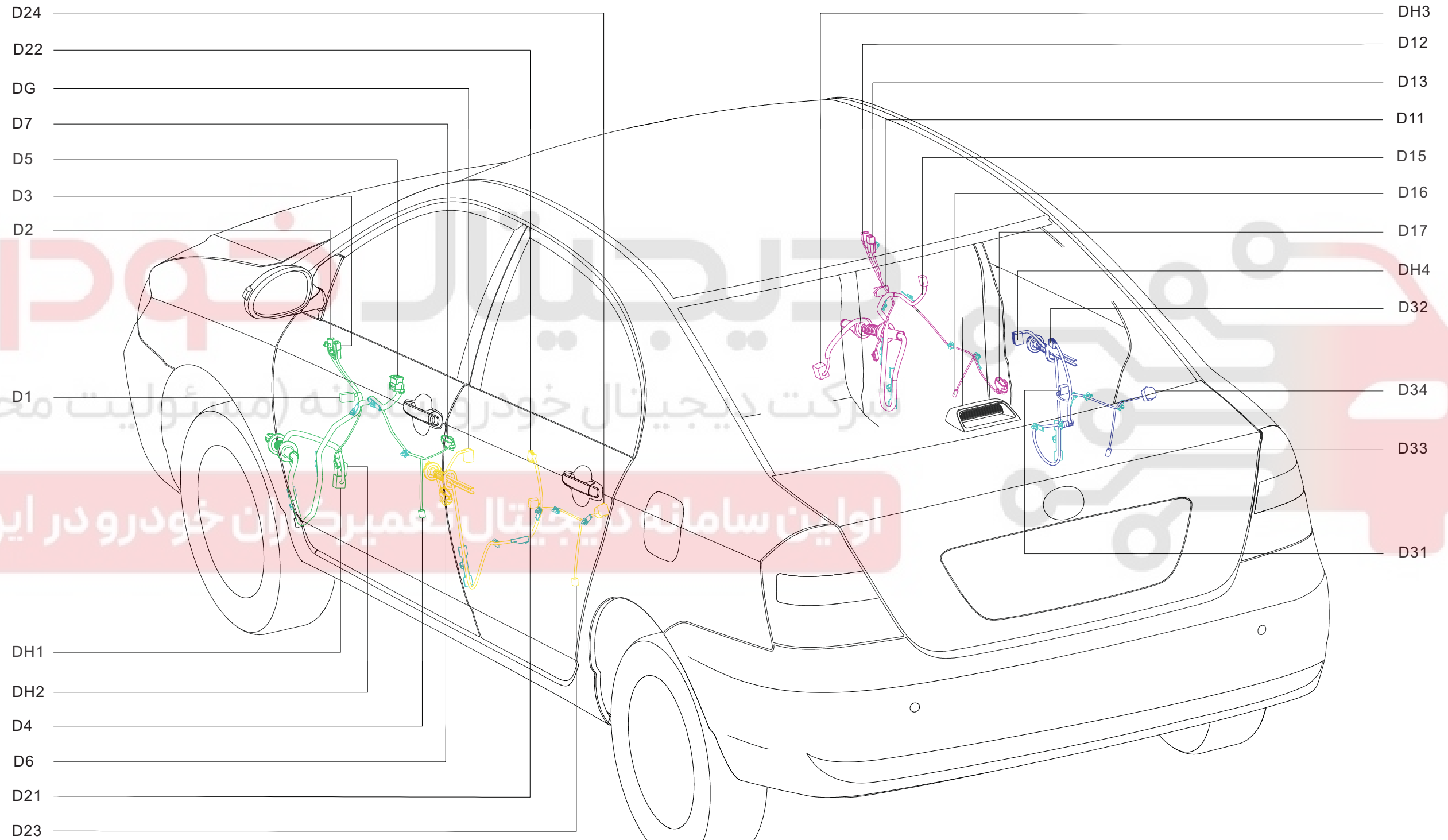

Harness Connector Location View

Roof Harness Connector Location View

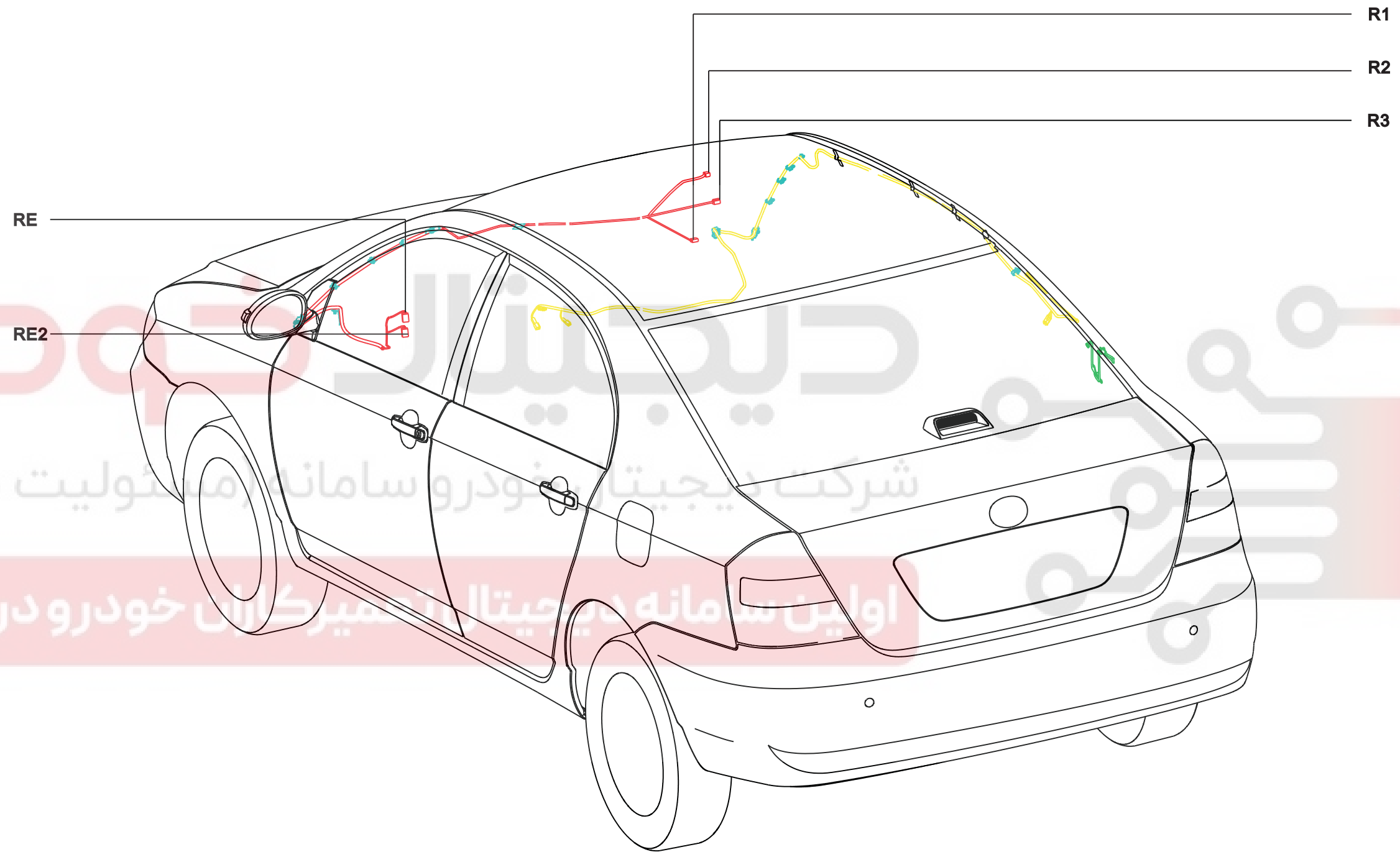

Harness Connector Location View

SRS Harness Connector Location View

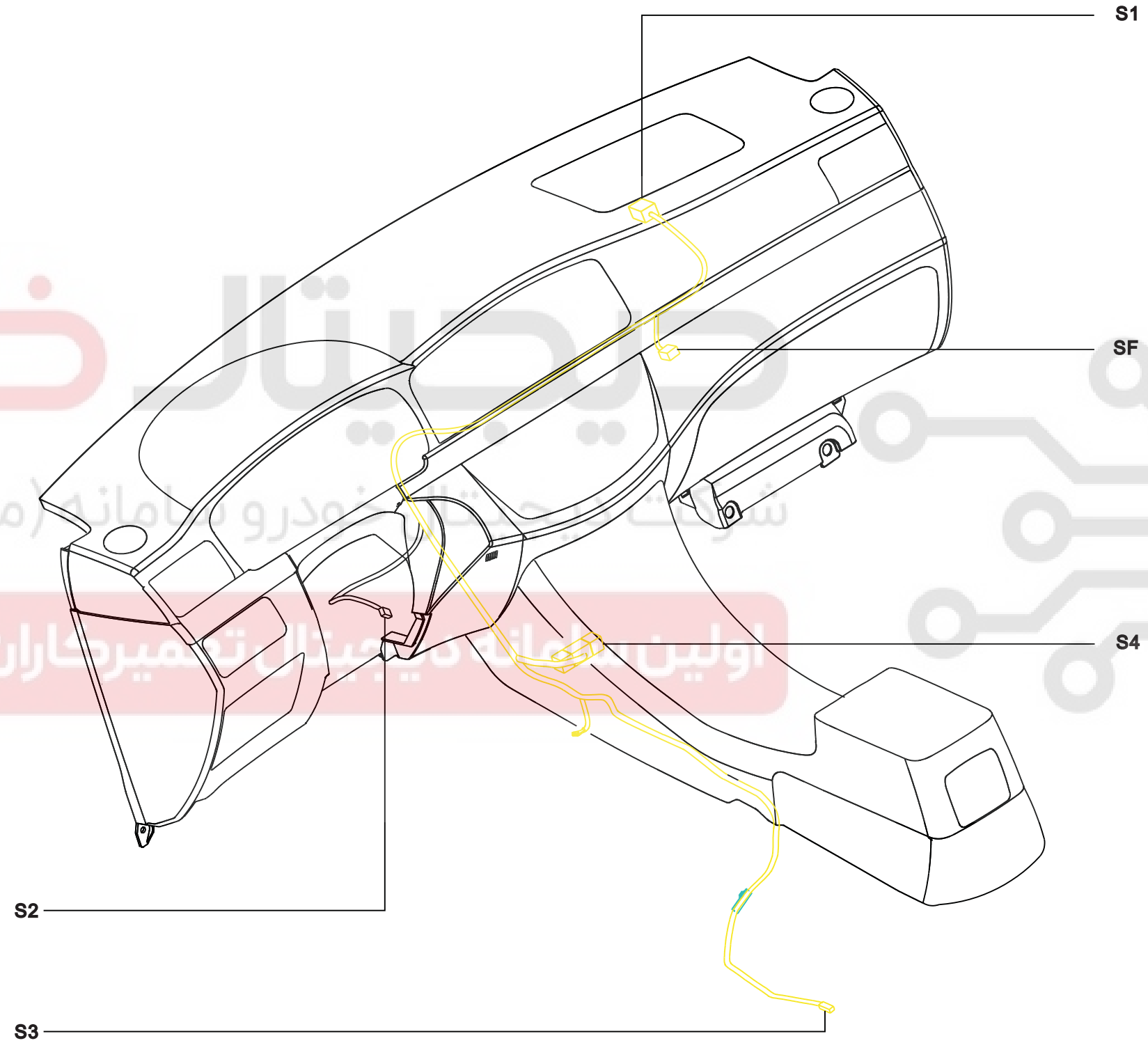

Harness Connector Location View

G01

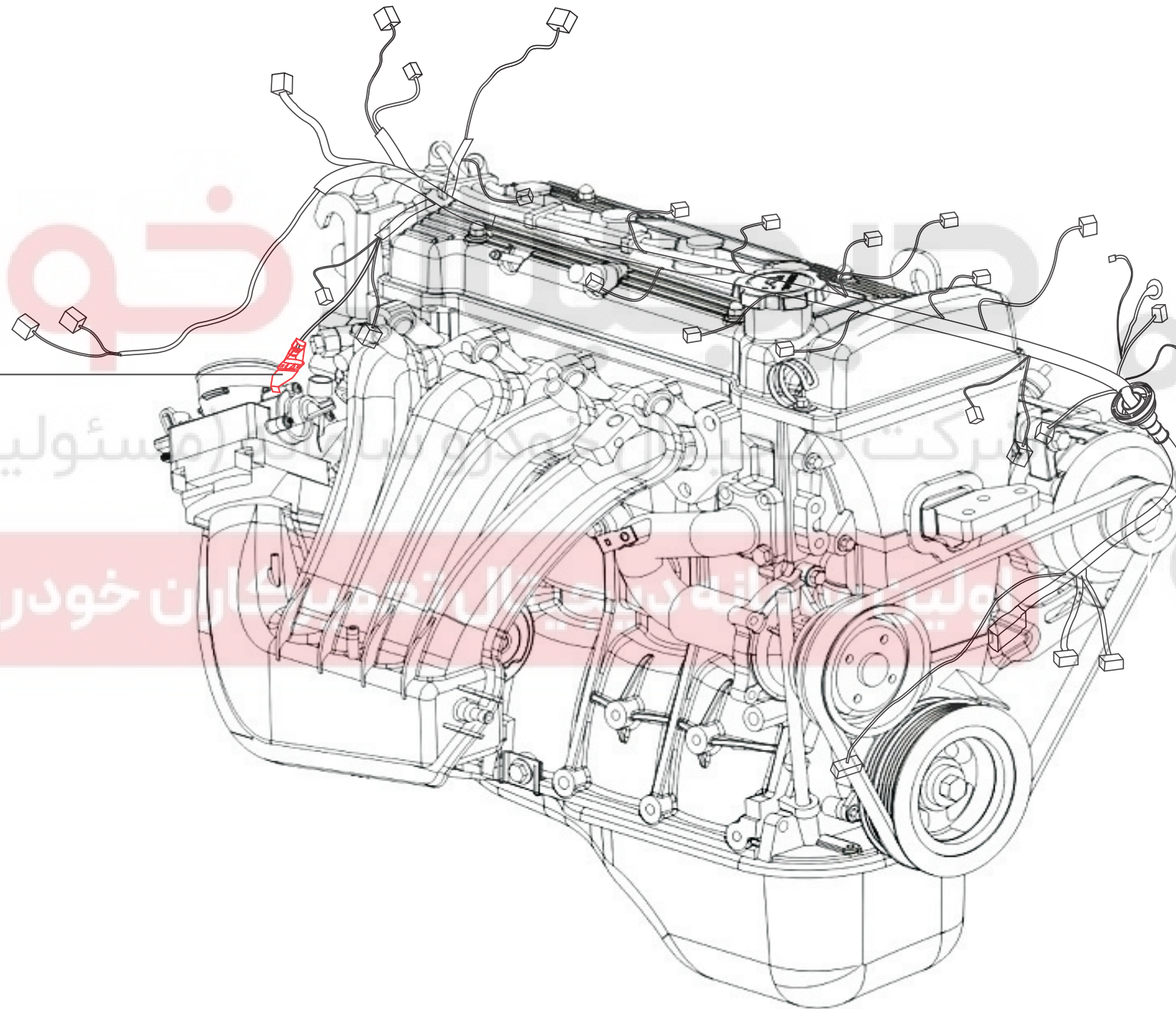

Harness Connector Location View

G03/G11/G12/G13

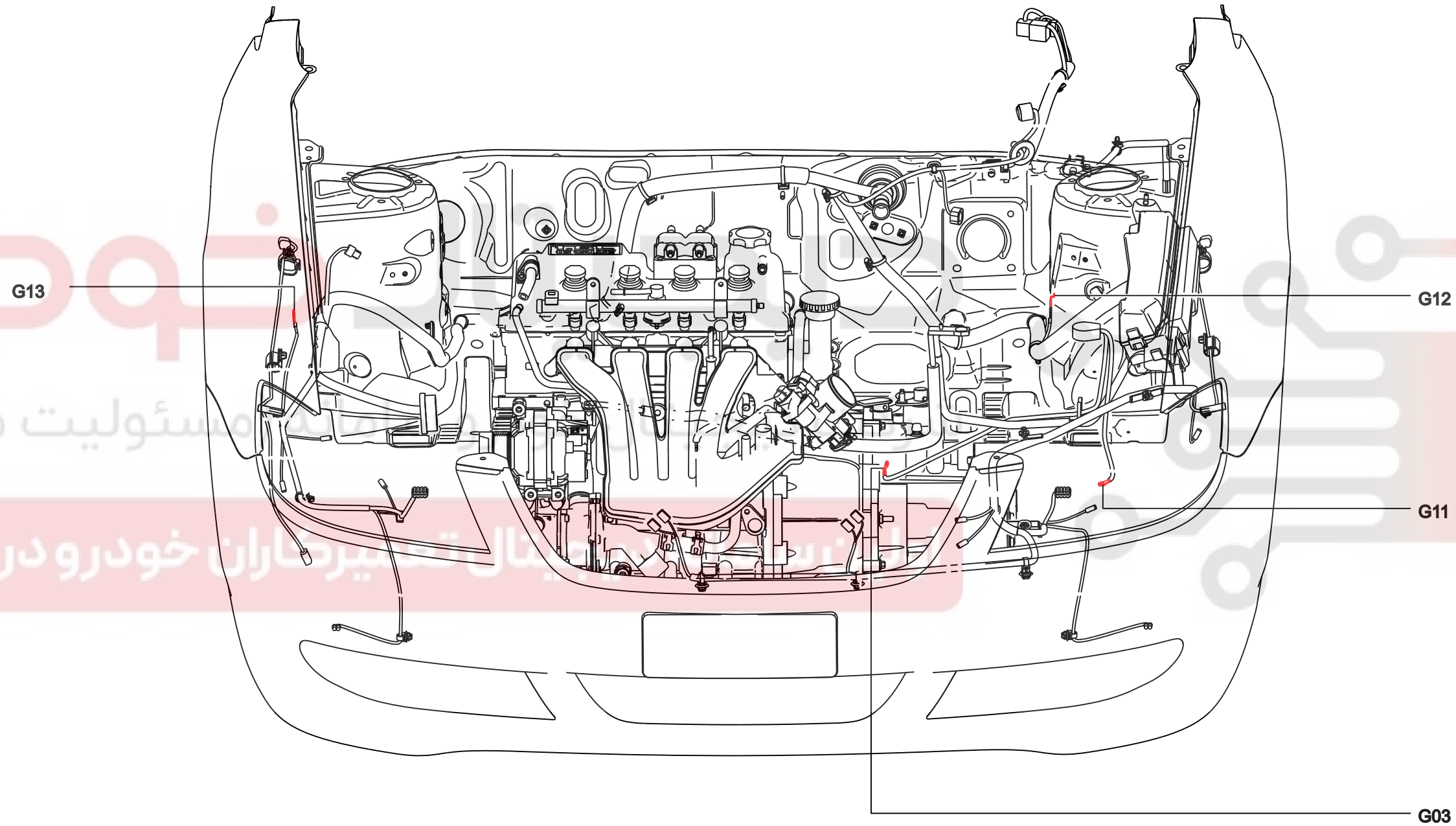

Harness Connector Location View

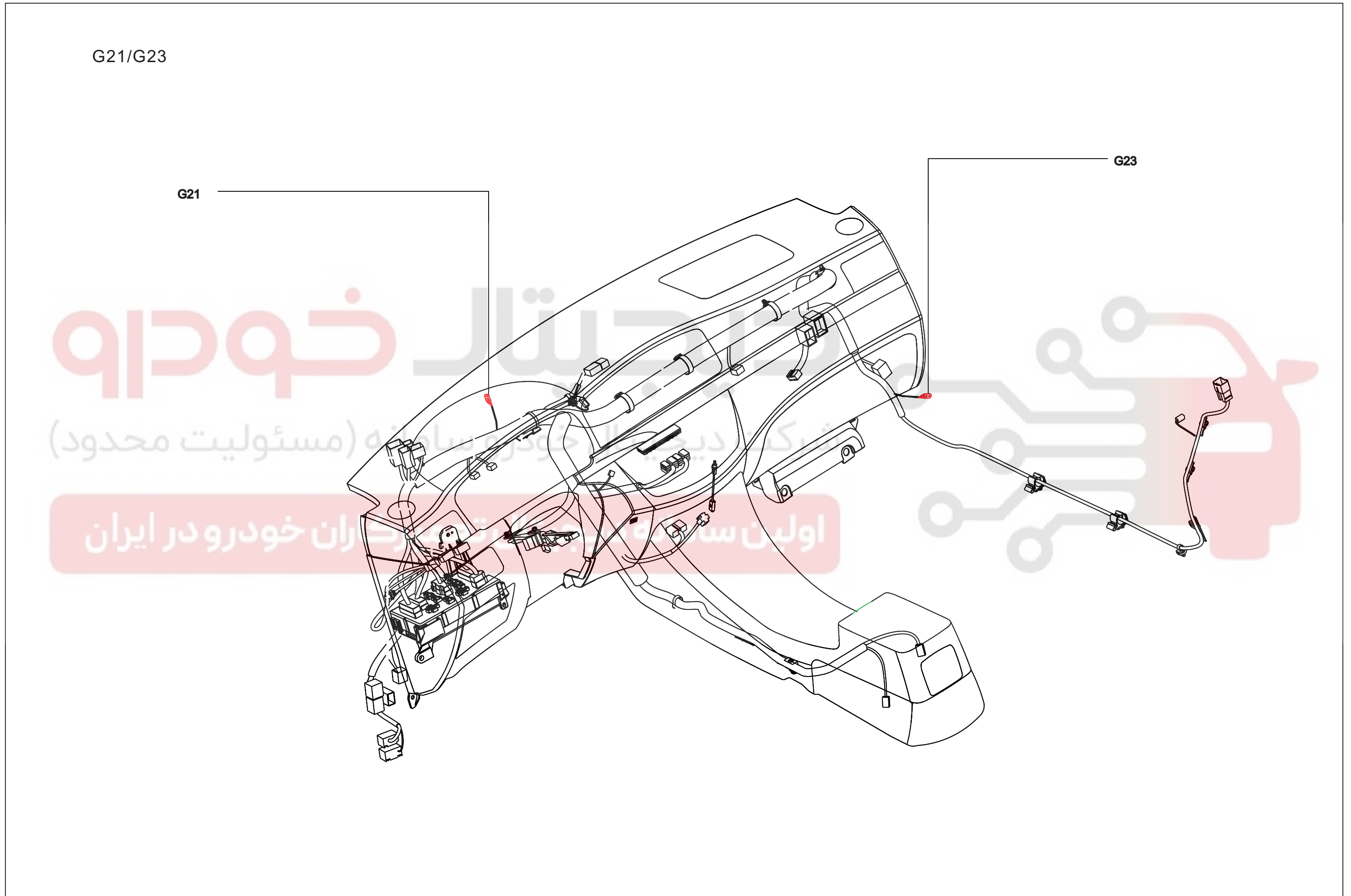

Harness Connector Location View

G22

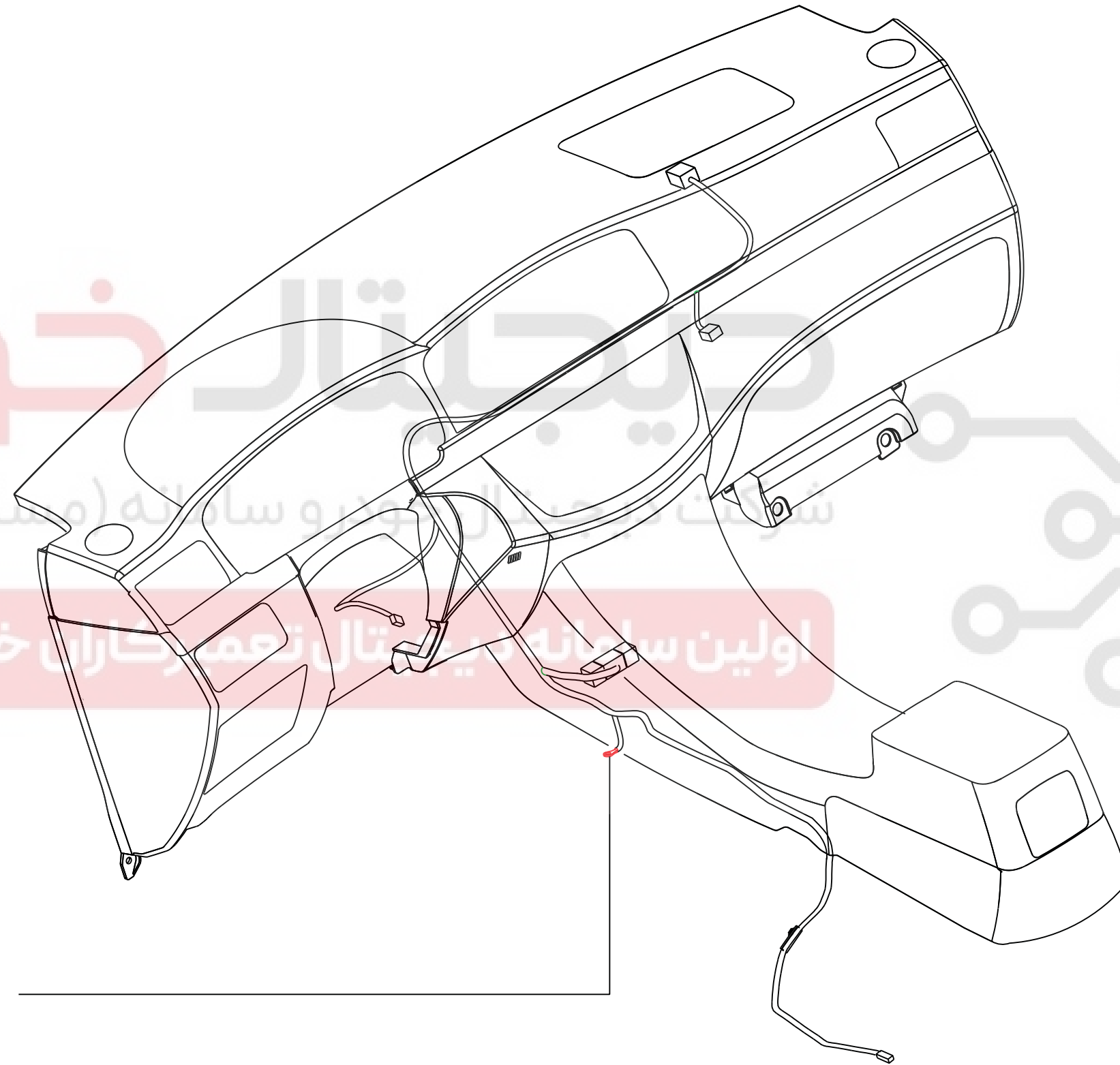

G22

Harness Connector Location View

G27

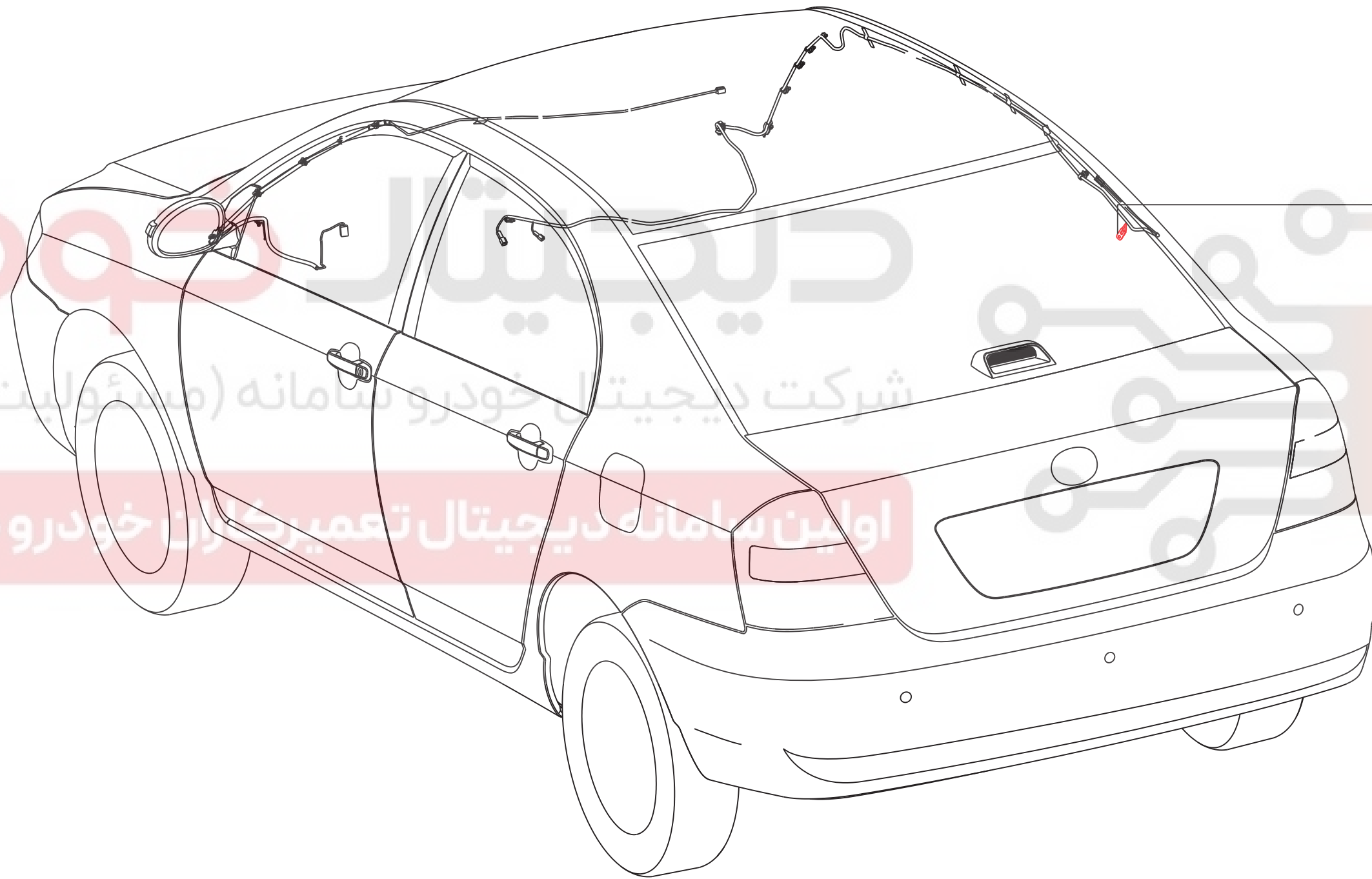

G27

Harness Connector Location View

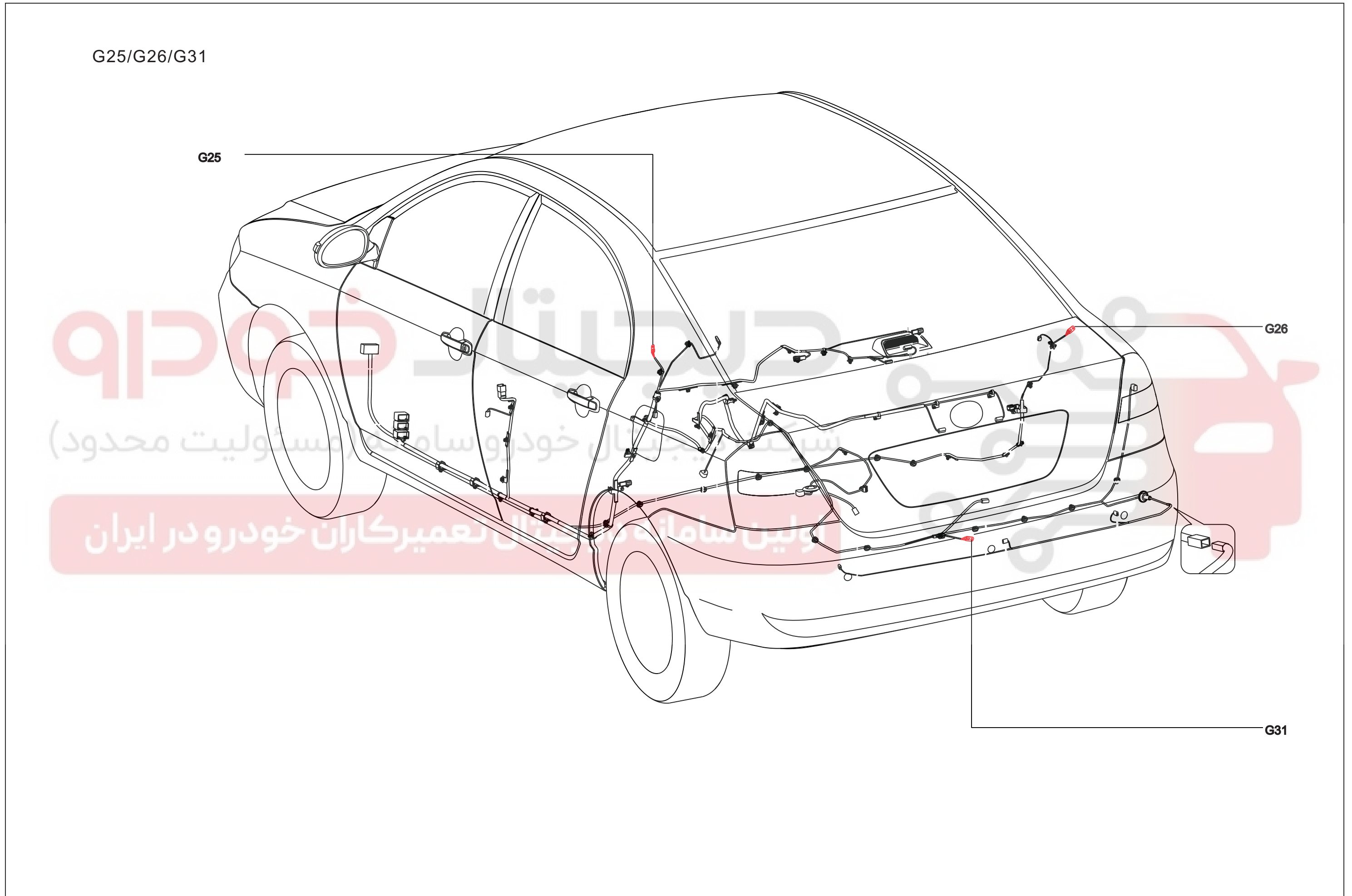

Harness Connector View

Engine Harness Connector (E--)

Engine Harness Connector

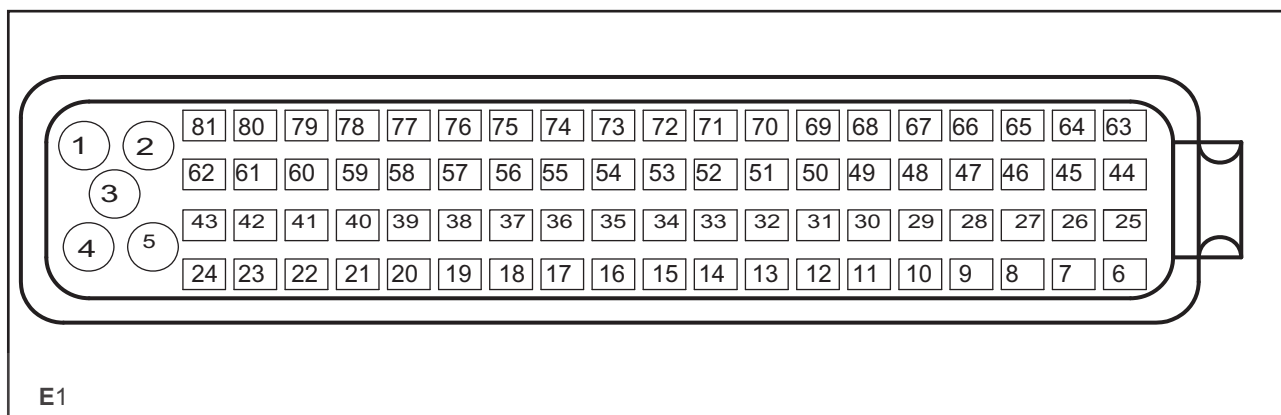

E1

E1 Pin Definition

Pin Number	Wire Width / Color	Function
1	0.50 W/Y	Ignition signal (Cylinder-3)
2	0.85 B	Ground
3	0.85 B	Ground
4	0.50 P/Y	Ignition signal (Cylinder-1)
5	0.50 BI/R	Injection signal
6	0.50 O/B	Injection signal (Cylinder-1)
7	0.50 P/Y	Injection signal (Cylinder-3)
8	0.50 Y/R	Injection signal (Cylinder-2)
9	0.50 B/O	Fuel pump control signal
10	0.50 W	A/C clutch relay signal
11	0.50 BI	CKP signal -
12	0.30 W/BI	SVS indicator Signal
13	--	
14	--	
15	--	
16	--	
17	0.50 R/BI	Fan Relay(High speed)
18	--	
19	0.30 G	OBD indicator
20	0.50 V	ETC power -
21	0.50 Y	ETC power +
22	--	
23	0.50 G	Rear oxygen sensor heating signal

Pin Number	Wire Width / Color	Function
24	0.50 V/W	Front oxygen sensor heating signal
25	0.50 G/Br	Injection signal (Cylinder-4)
26	--	
27	0.50 P	ETC signal 2
28	--	
29	--	
30	0.50 G	CKP signal +
31	--	
32	--	
33	0.5 BI/R	Brake lamp switch signal
34	--	
35	0.3 W/BI	Headlamp load signal
36	0.30 W	KC signal +
37	0.30 B	KC signal -
38	0.50 BI/W	CAN L
39	0.50 BI/B	CAN H
40	0.50 G	A/C pressure switch signal
41	0.50 R/Y	Accelerator signal 1
42	0.50 Gr	Accelerator signal 2
43	0.50 Y/W	OCV Signal
44	0.50 Y	Main relay signal
45	--	
46	0.50 P/W	IMMO communication
47	0.50 O/Y	Front oxygen sensor signal
48	0.50 Gr	Rear oxygen sensor signal
49	0.85 Y/B	Coolant temperature sensor signal
50	--	
51	0.50 O/G	Vehicle speed signal
52	0.30 BI/G	ETC signal 1
53	--	
54	0.50 P	MAP signal
55	--	
56	--	

Harness Connector View

Engine harness to I/P harness connector

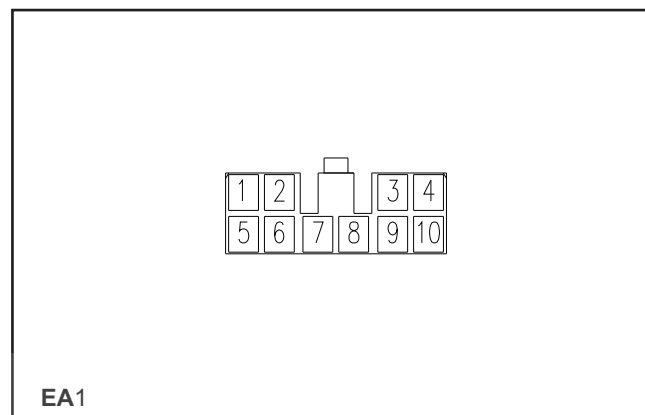

EA1 Pin Definition

Pin Number	Wire Width / Color	Function
1	--	
2	--	
3	0.50 G/R	Reverse switch signal
4	0.50 G/Br	Power
5	0.50 BI/B	CAN-H
6	0.50 BI/W	CAN-L
7	3.00 B/Y	Ignition switch
8	--	
9	0.50 B/R	Fuel pump relay signal
10	0.50 W/BI	Rear oxygen heating sensor

Engine harness to I/P harness connector

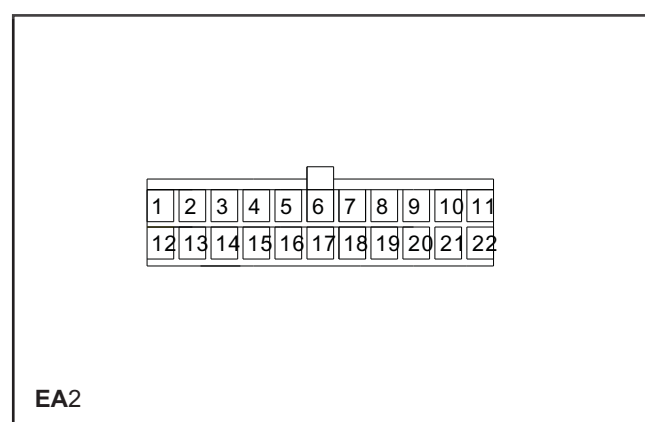

EA2 Pin Definition

Pin Number	Wire Width / Color	Function
1	0.50 P/W	IMMO Communication
2	0.50 G/W	Brake switch signal
3	0.50 G	OBD Indicator
4	0.50 V	Charging signal
5	0.50 Y/B	Engine oil pressure signal
6	0.50 Br	Coolant temperature signal
7	--	
8	0.50 W/BI	SVS indicator signal
9	0.50 W/B	Engine speed output signal
10	0.50 G	Rear oxygen sensor signal
11	--	
12	0.50 P/G	K-line
13	0.50 BI/R	Brake lamp switch signal
14	--	
15	0.50 R/Gr	IAT signal
16	--	
17	0.50 V/B	Front oxygen sensor signal
18	--	
19	0.50 Gr	Rear oxygen sensor signal
20	0.50 B/Y	Fuel pump signal
21	--	
22	0.50 O/G	Vehicle speed signal

Harness Connector View

Accelerator Pedal Connector

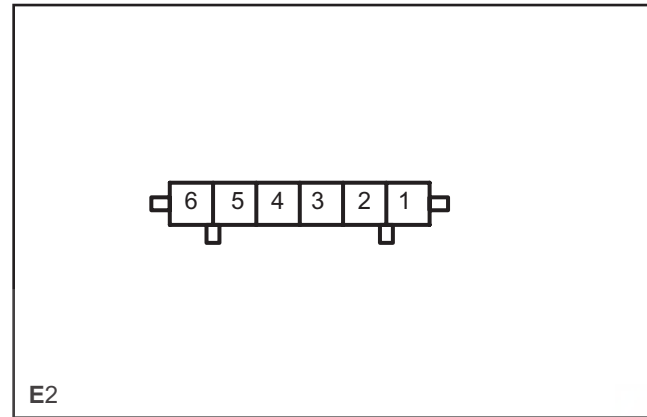

E2 Pin Definition

Pin Number	Wire Width / Color	Function
1	0.50 R/W	Power 5V
2	0.50 R/B	Power 5V
3	0.50 W	Ground
4	0.50 R/Y	Accelerate Signal 1
5	0.50 R/B	Ground
6	0.50 Gr	Accelerate Signal 2

Engine Harness to Injection (Cylinder-1) Connector

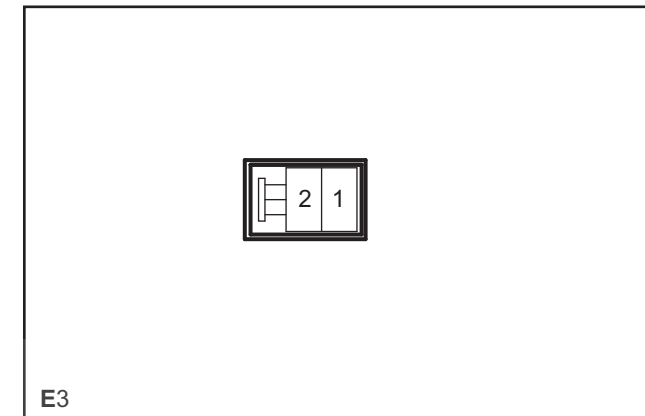

E3 Pin Definition

Pin Number	Wire Width / Color	Function
1	0.50 BI/R	Power 12V
2	0.50 O/B	Signal

Engine Harness to Injection (Cylinder-2) Connector



E4 Pin Definition

Pin Number	Wire Width / Color	Function
1	0.50 BI/R	Power 12V
2	0.50 Y/R	Signal

Harness Connector View

Engine Harness to Injection (Cylinder-3) Connector

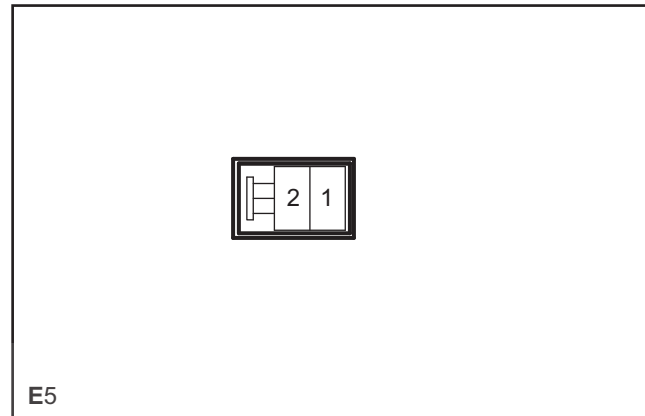

E5 Pin Definition

Pin Number	Wire Width / Color	Function
1	0.50 BI/R	Power 12V
2	0.50 P/Y	Signal

Engine Harness to Injection (Cylinder-4) Connector



E6 Pin Definition

Pin Number	Wire Width/Color	Function
1	0.50 BI/R	Power 12V
2	0.50 G/Y	Signal

Ignition Coil Connector (Cylinder-1)

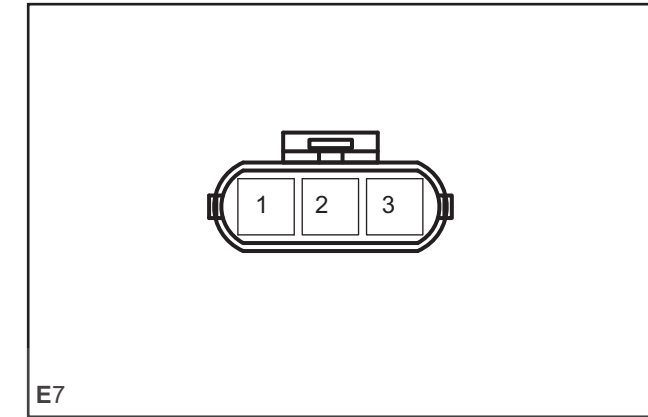

E7 Pin Definition

Pin Number	Wire Width/Color	Function
1	1.00 B/W	Power 12V
2	0.50 B	Ground
3	0.50 P/Y	Ignition signal

Ignition Coil Connector (Cylinder-2)

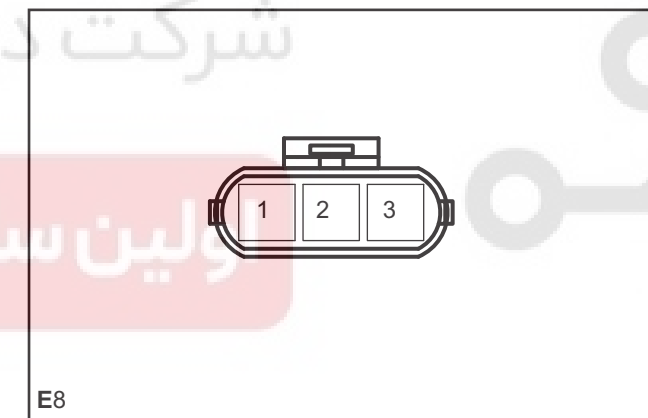

E8 Pin Definition

Pin Number	Wire Width/Color	Function
1	1.00 B/W	Power 12V
2	0.50 B	Ground
3	0.50 W/Y	Ignition Signal

Harness Connector View

Injector Connector (Cylinder-3)

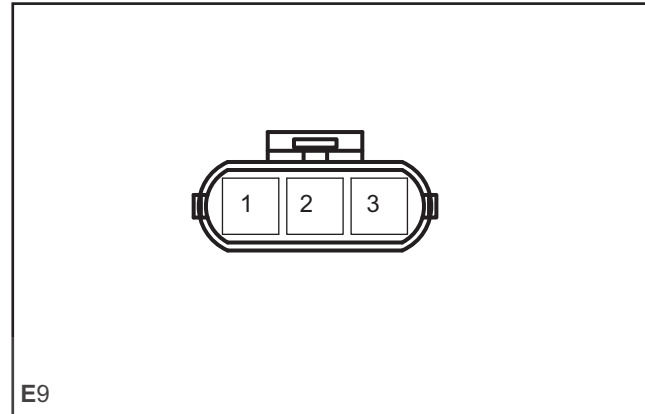

E9 Pin Definition

Pin Number	Wire Width / Color	Function
1	1.00 B/W	Power 12V
2	0.50 B	Ground
3	0.50 W/Y	Ignition Signal

Injector Connector (Cylinder-4)



E10 Pin Definition

Pin Number	Wire Width / Color	Function
1	1.00 B/W	Power 12V
2	0.50 B	Ground
3	0.50 P/Y	Ignition Signal

Canister Connector

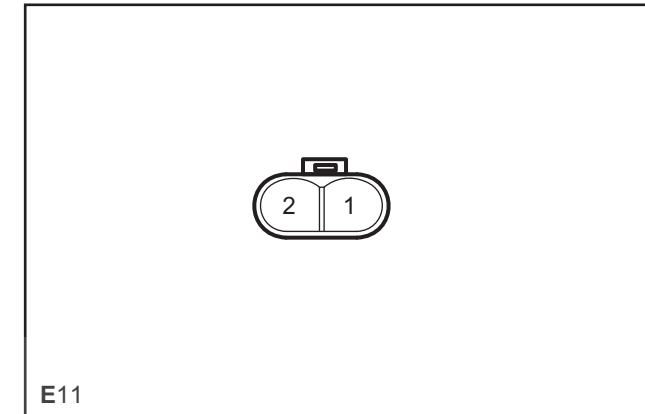

E11 Pin Definition

Pin Number	Wire Width / Color	Function
1	0.50 BI/R	Power 12V
2	0.50 W/G	Signal

Vehicle Speed Sensor Connector



E12 Pin Definition

Pin Number	Wire Width / Color	Function
1	0.50 BI/R	Power
2	0.50 B/Y	Ground
3	0.50 W/Y	Signal

Harness Connector View

Reverse Lamp Connector

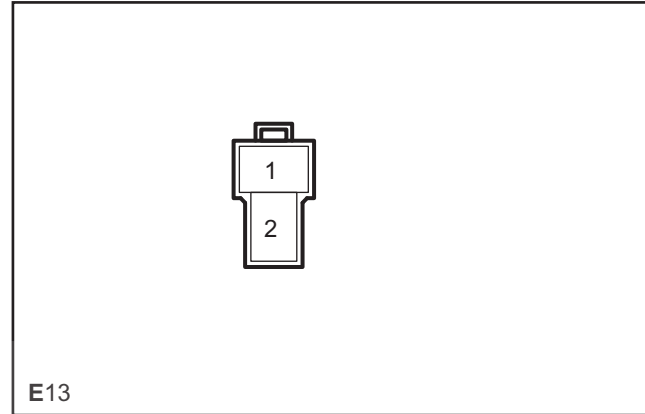

E13 Pin Definition

Pin Number	Wire Width / Color	Function
1	0.50 G/R	Reverse switch signal
2	0.50 G/Br	Power 12V

CKP Sensor Connector



E14 Pin Definition

Pin Number	Wire Width / Color	Function
1	0.50 G	Signal +
2	0.50 Bl	Signal -
3	0.50 B	Ground

CTS Sensor Connector

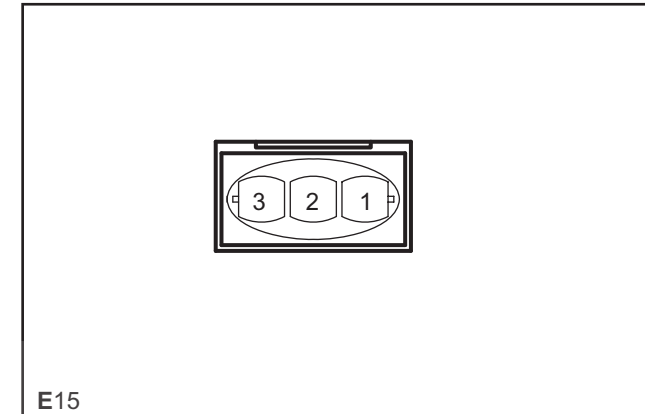

E15 Pin Definition

Pin Number	Wire Width / Color	Function
1	0.50 Y/B	Ground
2	--	
3	0.50 W	Signal

CMP sensor Connector

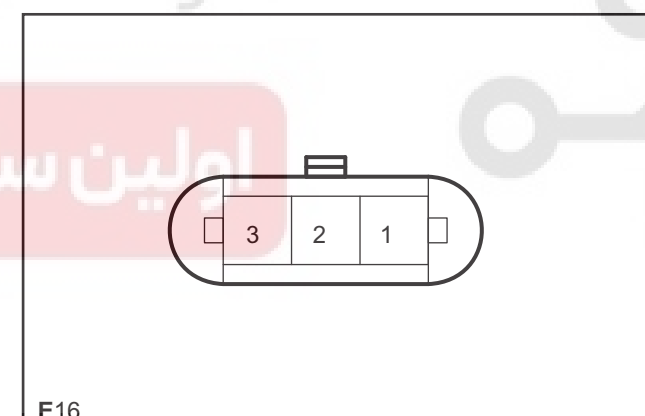

E16 Pin Definition

Pin Number	Wire Width / Color	Function
1	0.50 G/W	Power 5V
2	0.50 W	Ground
3	0.50 R/B	Signal

Harness Connector View

ETC

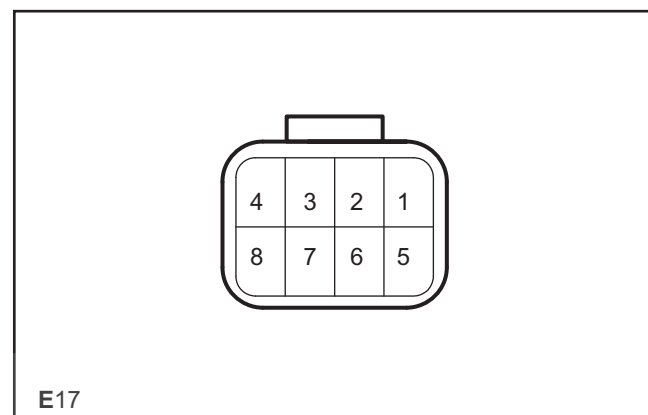

E17 Pin Definition

Pin Number	Wire Width / Color	Function
1	0.50 W	Ground
2	0.50 B/G	Signal 1
3	0.50 P	Signal 2
4	0.50 R/B	Power 5V
5	0.50 Y	Power +
6	--	
7	--	
8	0.50 V	Power -

Knock Sensor Connector

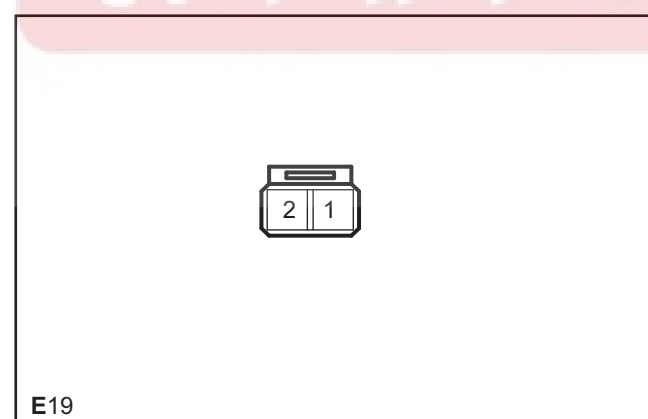

E19 Pin Definition

Pin Number	Wire Width / Color	Function
1	0.50 B	Signal -
2	0.50 W	Signal +

TEMP sensor connector

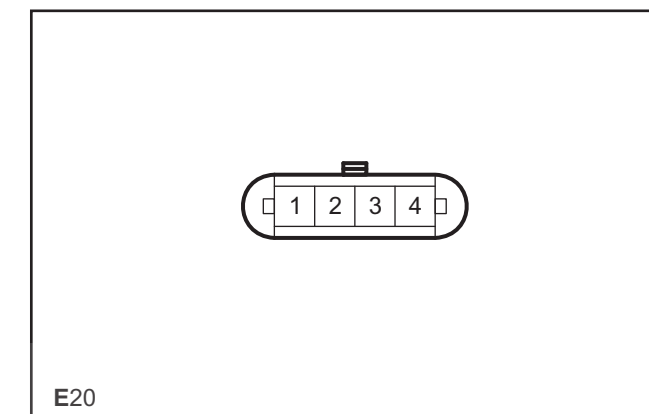

E20 Pin Definition

Pin Number	Wire Width / Color	Function
1	0.50 R/B	Ground
2	0.50 BI	Temperature signal
3	0.50 R/W	Power
4	0.50 P	Pressure signal

Starter Motor Connector

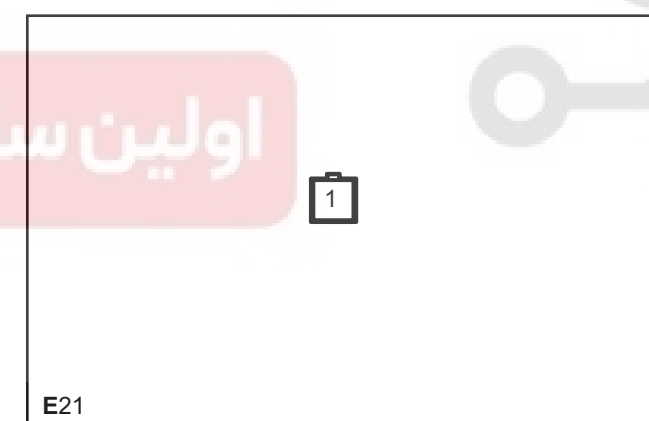

E21 Pin Definition

Pin Number	Wire Width / Color	Function
1	3.00 B/Y	Power 12V

Harness Connector View

Engine oil pressure switch connector

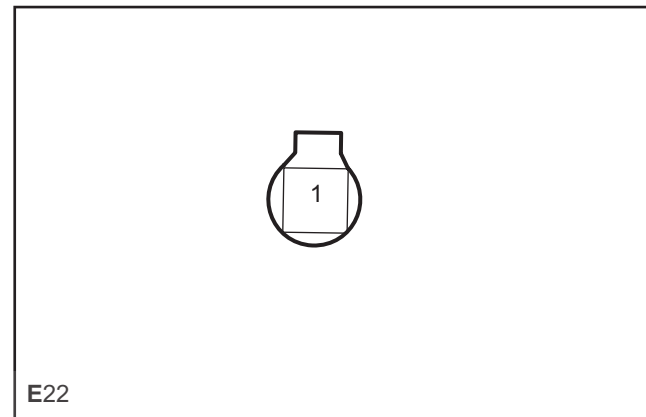

E22 Pin Definition

Pin Number	Wire Width / Color	Function
1	0.50 Y/B	Signal

Compressor connector

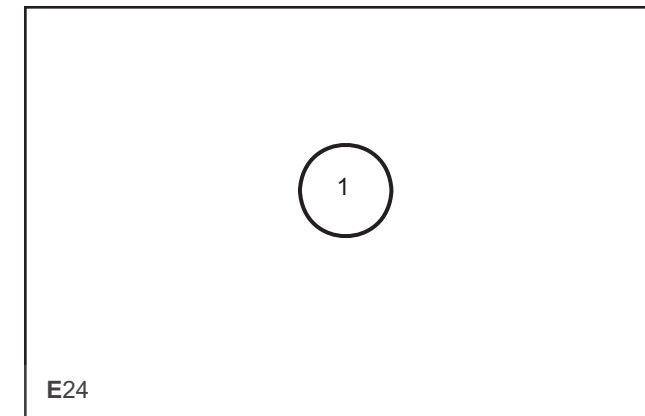

E24 Pin Definition

Pin Number	Wire Width / Color	Function
1	0.50 Y/W	Power 12V

Alternator Connector



E23 Pin Definition

Pin Number	Wire Width / Color	Function
1	1.00 R	Power 12V
2	1.00 B/W	IG2 Power 12V
3	1.00 V	Indicator signal

Engine Harness to OCV Connector



E25 Pin Definition

Pin Number	Wire Width / Color	Function
1	0.50 BI/R	Power 12V
2	0.50 Y/W	Signal

Harness Connector View

HPS switch connector

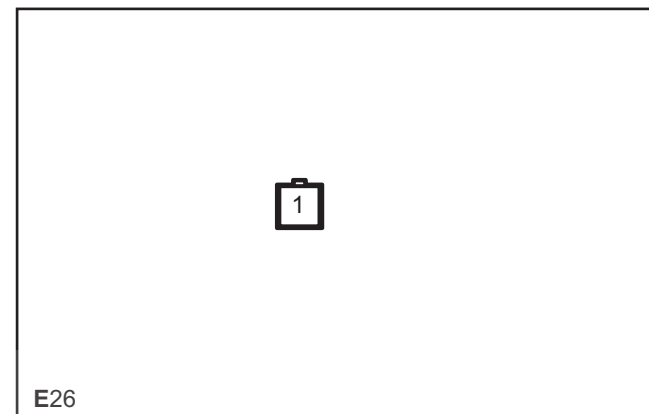

E26 Pin Definition

Pin Number	Wire Width / Color	Function
1	0.50 B/G	Signal

Engine Harness to Front Oxygen Sensor Connector

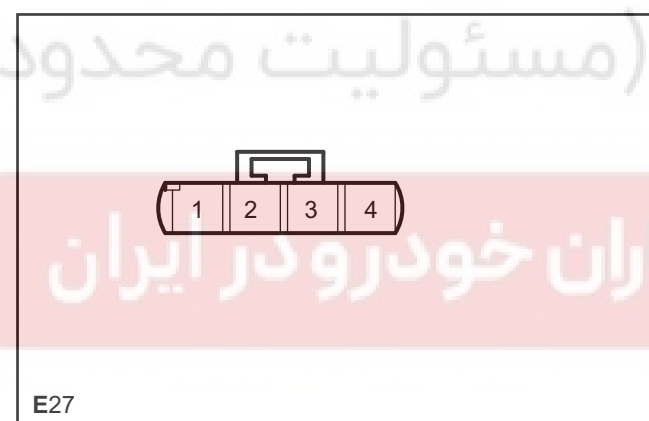

E27 Pin Definition

Pin Number	Wire Width / Color	Function
1	0.50 V/B	Front oxygen sensor
2	0.50 R/Y	Front oxygen signal
3	0.50 V/W	Heating signal
4	0.50 W/BI	Heating power 12V

Engine harness to Engine Compartment harness connector

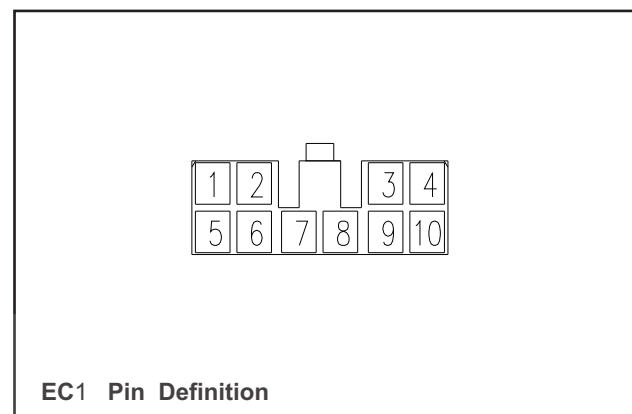

EC1 Pin Definition

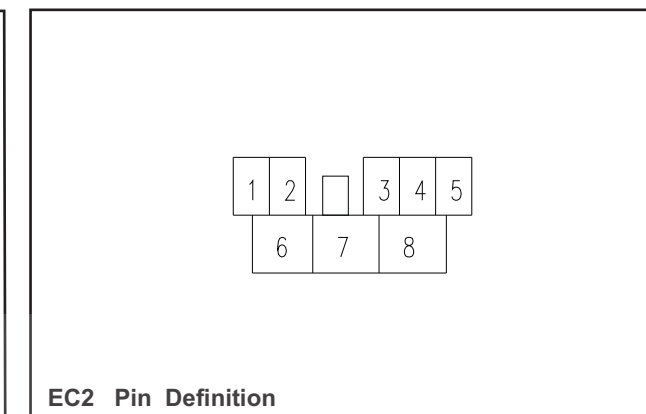

EC2 Pin Definition

EC1 Pin Definition

Pin Number	Wire Width / Color	Function
1	0.50 Y	Main relay signal
2	0.50 W	A/C clutch relay signal
3	0.50 R/BI	A/C signal
4	0.50 W/BI	Power
5	0.50 R	ECU B+
6	0.50 R/BI	Fan relay signal (High speed)
7	0.50 W/G	Weak accelerate sensor signal
8	0.50 R/W	Power 5V
9	0.50 Y/W	Power 12V
10	0.50 BI/Y	Fan signal(Low speed)

EC2 Pin Definition

Pin Number	Wire Width / Color	Function
1	--	
2	--	
3	--	
4	--	
5	--	
6	0.50 B/W	Alternater +IG1
7	0.50 G	A/C pressure switch signal
8	0.50 W/BI	Headlamp signal

Harness Connector View

Engine Compartment harness Connector(U--)

Brake Fluid Level Switch Connector

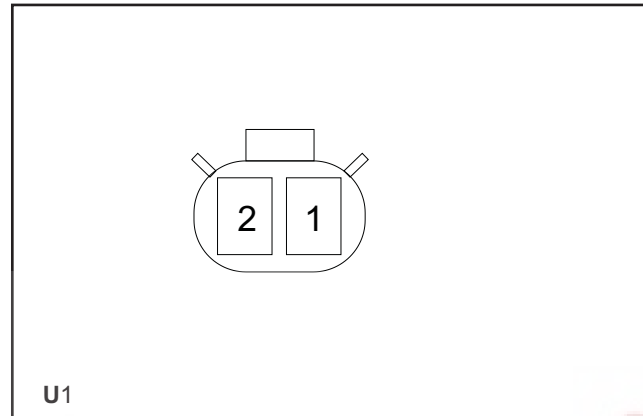

U1 Pin Definition

Pin Number	Wire Width / Color	Function
1	0.50 B	Ground
2	0.50 V/W	Power

Front Wiper Motor Connector

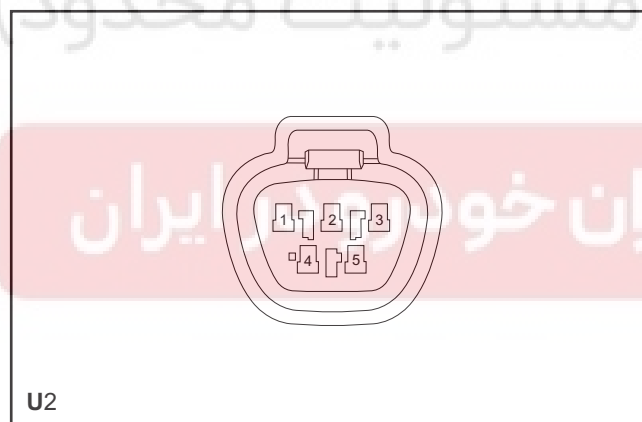

U2 Pin Definition

Pin Number	Wire Width / Color	Function
1	0.85 Y/BI	Low Speed power
2	1.25 BI	Power
3	0.85 Y/G	Reset
4	0.85 B/BI	High speed power
5	1.25 B	Ground

Engine Compartment Harness to ABS Connector

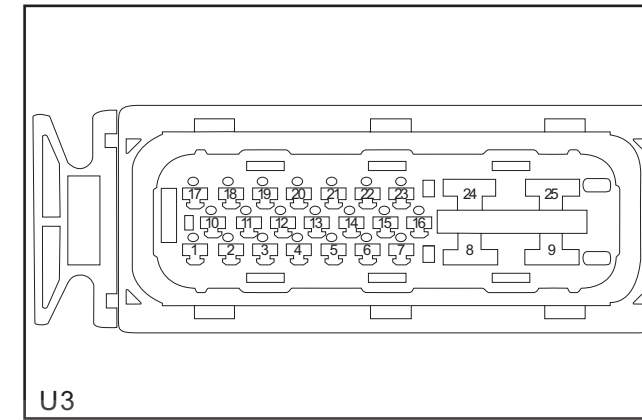

U3 Pin Definition

Pin Number	Wire Width/Color	Function
1	0.50 B/BI	Wheel speed sensor(LF)signal+
2	0.50 BI	Wheel speed sensor(LF)signal-
3	--	
4	0.50 B/W	Power(+)
5	0.50 P	Wheel speed sensor(LR)signal+
6	0.50 P/B	Wheel speed sensor(LR)signal-
7	0.50 V	K-line signal
8	3.00 B	Ground
9	3.00 W/BI	Power 12V
10	--	
11	--	
12	--	
13	--	
14	--	
15	--	
16	0.50 W/G	ABS indicator
17	--	
18	0.85 G/W	Brake signal
19	0.50 G/B	Wheel speed sensor(RF)signal+
20	0.50 G	Wheel speed sensor(RF)signal-
21	--	
22	0.50 Y	Wheel speed sensor(RR)signal-
23	0.50 Y/B	Wheel speed sensor(RR)signal+
24	3.00 B	Ground
25	3.00 W	Power

Harness Connector View

A/C Pressure Switch Connector

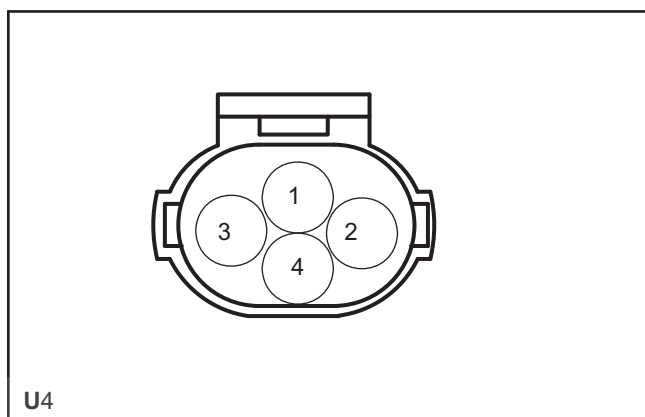

U4 Pin Definition

Pin Number	Wire Width / Color	Function
1	0.50 G/BI	A/C Signal
2	0.50 B	Ground
3	0.50 G/R	A/C panel application signal
4	0.50 G/Br	A/C pressure switch signal

RF Turn Lamp connector



U5 Pin Definition

Pin Number	Wire Width / Color	Function
1	0.50 B	Ground
2	0.50 Br/Y	Power

Adjust the Headlamp Axle Motor Connector

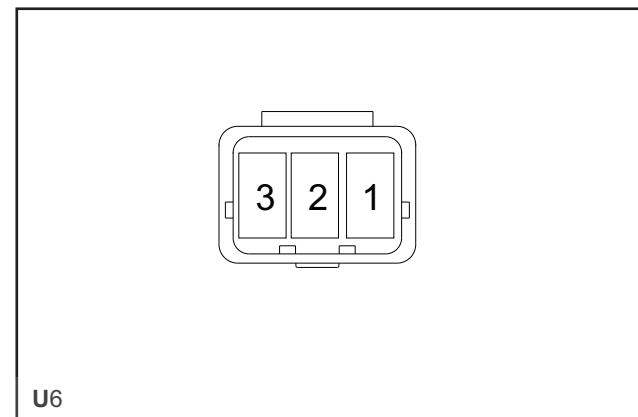

U6 Pin Definition

Pin Number	Wire Width / Color	Function
1	0.50 B	Ground
2	0.50 G/B	Signal
3	0.50 R/B	Low beam signal

Headlamp Connector (R)



U7 Pin Definition

Pin Number	Wire Width / Color	Function
1	1.25 P/G	High beam signal
2	1.25 R/B	Low beam signal
3	0.85 G/R	Position lamp signal
4	2.00 B	Ground

Harness Connector View

Front Fog Lamp Connector

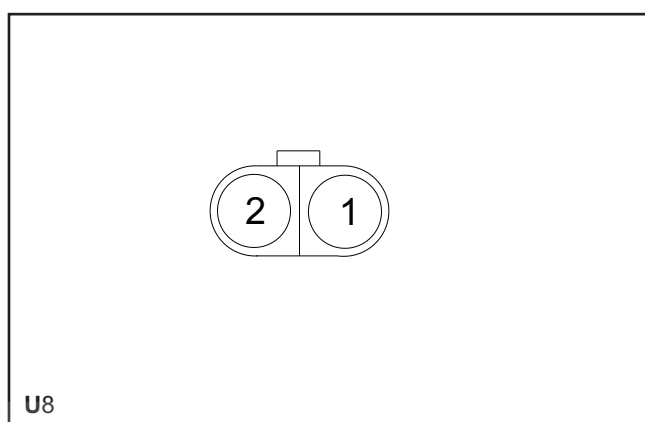

U8 Pin Definition

Pin Number	Wire Width / Color	Function
1	1.25 Y/W	Power
2	1.25 B	Ground

Wheel Speed Sensor Connector(RF)

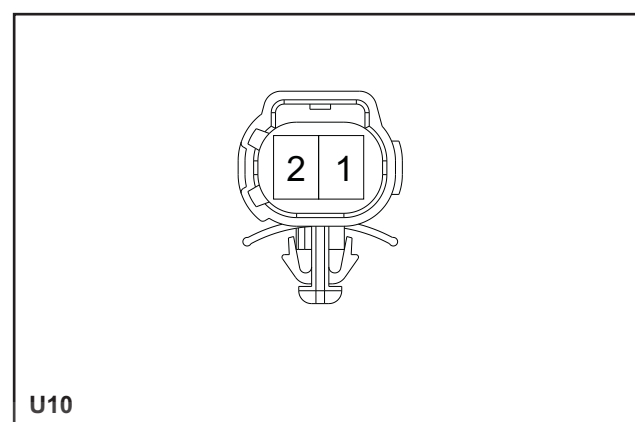

U10 Pin Definition

Pin Number	Wire Width / Color	Function
1	0.50 G/B	Signal+
2	0.50 G	Signal-

Washer Motor Connector

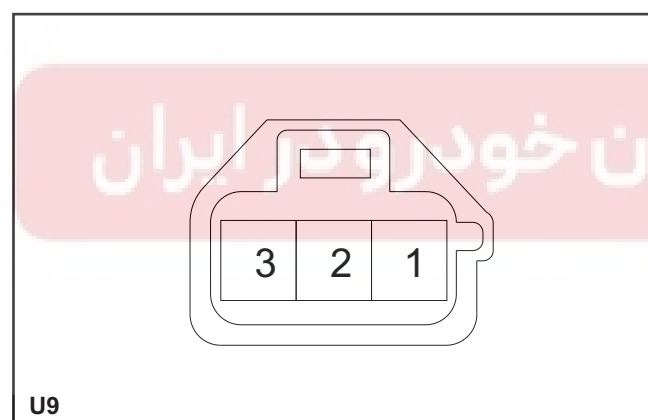

U9 Pin Definition

Pin Number	Wire Width / Color	Function
1	--	
2	0.50 B	Ground
3	0.50 G/B	Washer pump motor

LF Turn Lamp connector



U11 Pin Definition

Pin Number	Wire Width / Color	Function
1	0.50 B	Ground
2	0.50 R/Y	Power

Harness Connector View

Wheel Speed Sensor Connector(LF)

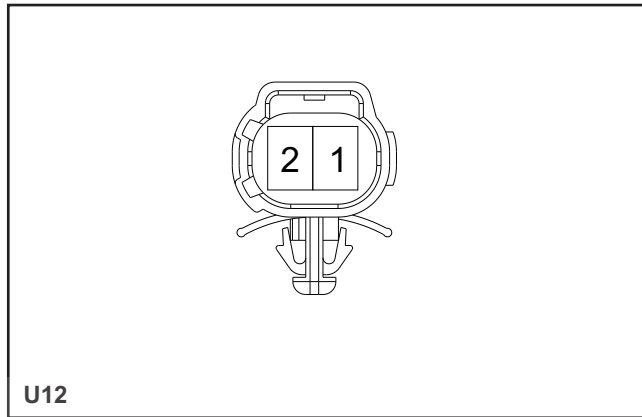

U12 Pin Definition

Pin Number	Wire Width / Color	Function
1	0.50 B/B	Signal+
2	0.50 BI	Signal-

Condenser Fan Connector(LF)

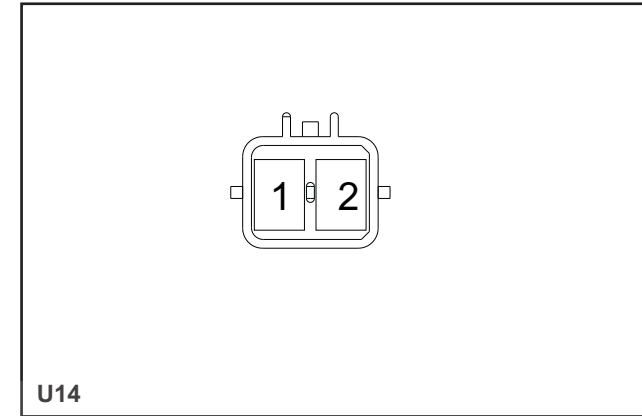

U14 Pin Definition

Pin Number	Wire Width / Color	Function
1	2.00 B/W	Signal-
2	2.00 B	Signal+

Front Fog Lamp Connector(L)



U13 Pin Definition

Pin Number	Wire Width / Color	Function
1	1.25 Y/W	Power
2	1.00 B	Ground

Coolant Fan Connector



U15 Pin Definition

Pin Number	Wire Width / Color	Function
1	2.00 B/R	Signal-
2	2.00 B/Y	Signal+

Harness Connector View

Adjust the Headlamp Axle Motor Connector

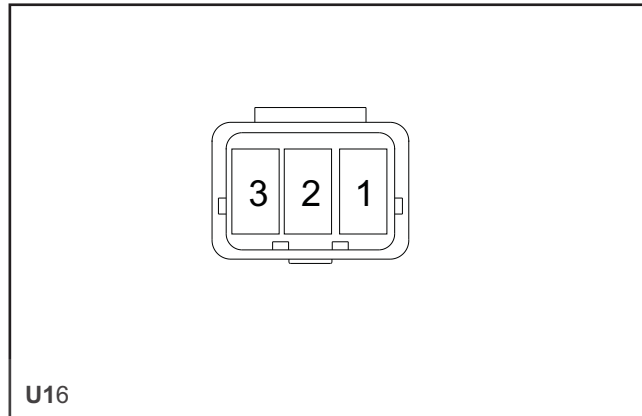

U16 Pin Definition

Pin Number	Wire Width / Color	Function
1	0.50 B	Ground
2	0.50 G/B	Signal
3	0.50 R/B	Signal

Headlamp Connector (L)



U17 Pin Definition

Pin Number	Wire Width / Color	Function
1	1.25 P/G	High beam signal
2	1.25 R/B	Low beam signal
3	0.85 G/R	Position lamp signal
4	2.00 B	Ground

Horn Connecto

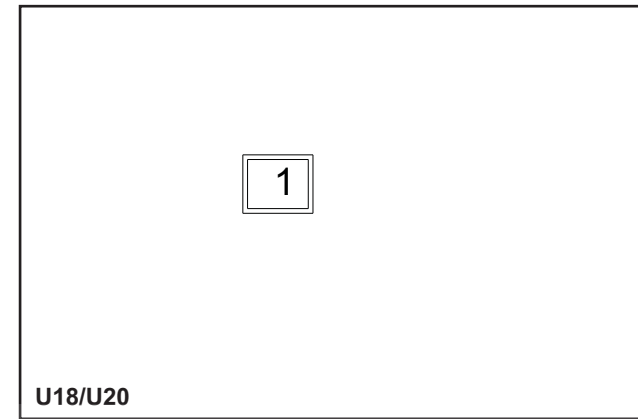

U18 Pin Definition

Pin Number	Wire Width / Color	Function
1	1.25 B	Ground

U20 Pin Definition

Pin Number	Wire Width / Color	Function
1	2.00 B	Ground

Horn Connector

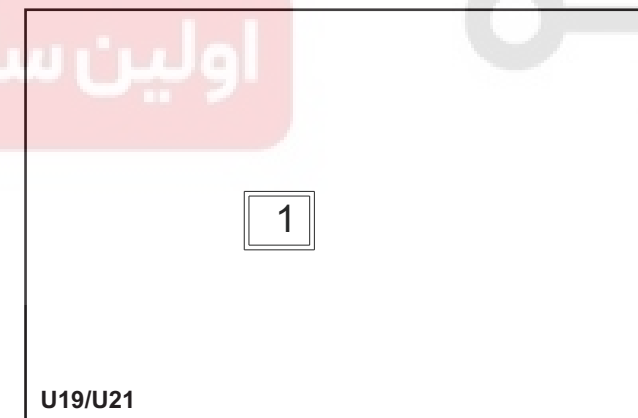

U19/U21 Pin Definition

Pin Number	Wire Width / Color	Function
1	1.25 BI/W	Power 12V

Harness Connector View

Outside Temperature Sensor Connector

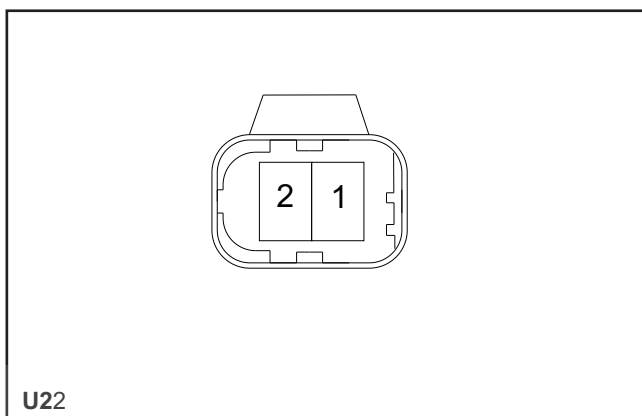

U22 Pin Definition

Pin Number	Wire Width / Color	Function
1	0.50 G	Signal+
2	0.50 B	Signal-

Engine Compartment harness to Body harness connector

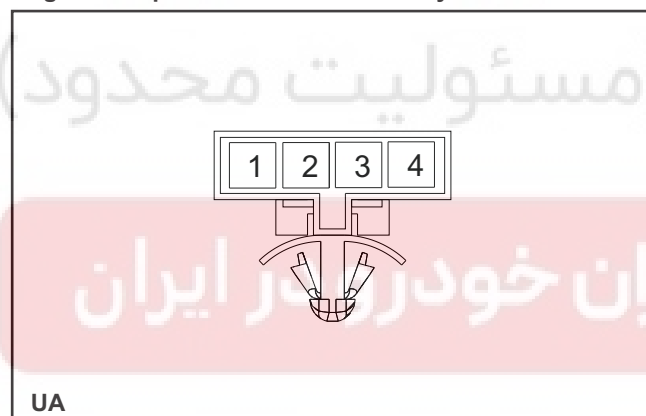

UA Pin Definition

Pin Number	Wire Width / Color	Function
1	0.50 P	Wheel speed sensor(LR) signal+
2	0.50 P/B	Wheel speed sensor(LR) signal-
3	0.50 Y	Wheel speed sensor(RR) signal-
4	0.50 Y/B	Wheel speed sensor(RR) signal+

Engine Compartment harness to I/P harness connector

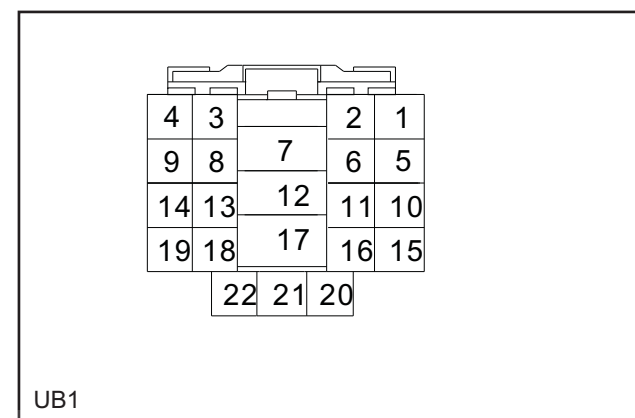

UB1 Pin Definition

Pin Number	Wire Width / Color	Function
1	0.50 V	K-line signal
2	0.30 W/O	Fog power
3	0.30 B/G	High beam relay
4	0.30 B/R	Overtaking relay
5	0.30 G/B	Washer pump motor
6	0.50 Y/G	Wiper motor(Low speed)
7	2.00 Y	Blower motor power
8	0.30 V/G	Headlamp control signal
9	0.50 G/R	Position lamp signal
10	0.30 B/BI	Wiper motor power (High speed)
11	0.50 BI	Power 12V
12	2.00 W	Engine compartment power
13	0.30 P/G	High beam signal
14	0.30 Y/W	Power
15	0.50 R/Y	Turn lamp signal
16	0.50 Br/Y	LF motor power
17	2.00 Y/B	Power 12V
18	0.50 W/G	ABS indicator
19	0.50 R/B	Low beam signal
20	0.5 V/W	Power
21	0.85 W/BI	Power 12V
22	0.5 Br/G	IG2

Harness Connector View

Engine Compartment harness to I/P harness connector

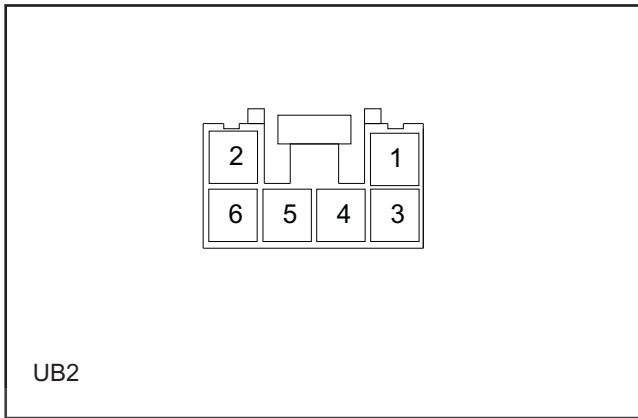

UB2 Pin Definition

Pin Number	Wire Width / Color	Function
1	0.50 G/B	Signal
2	0.85 G/W	Brake signal
3	0.5 B/W	Power +
4	0.50 R/Y	Power +
5	0.85 Y/G	Reset
6	0.50 R/G	A/C panel application signal

UB3 Pin Definition

Pin Number	Wire Width / Color	Function
1	--	
2	--	
3	--	
4	0.50 G	Signal +
5	--	
6	--	
7	--	
8	--	

Engine Compartment harness to I/P harness connector

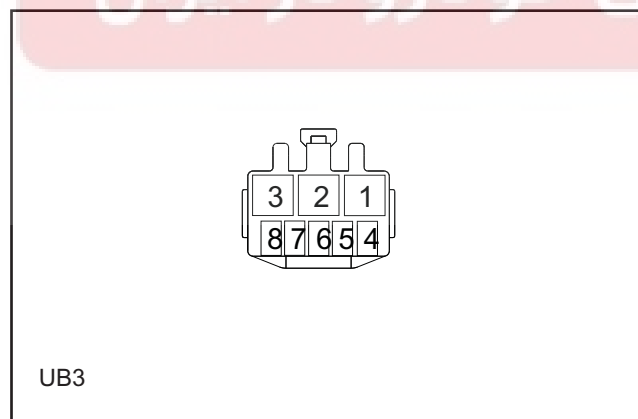

Harness Connector View

I/P Harness Connector(I--)

Light Sensor Connector

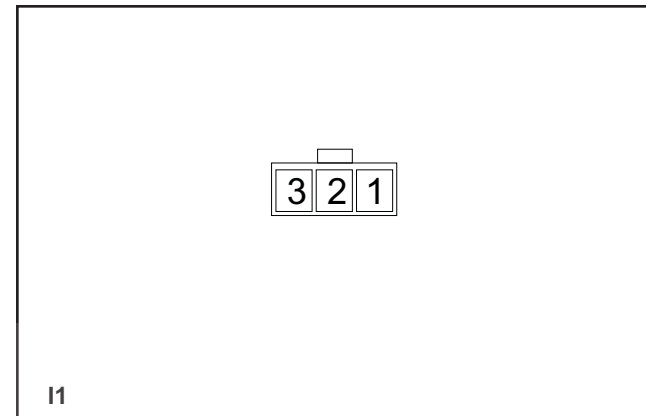

I1 Pin Definition

Pin Number	Wire Width / Color	Function
1	0.50 B	Ground
2	0.30 V/G	Signal
3	0.50 G	Position lamp power

Instrument Cluster Connector

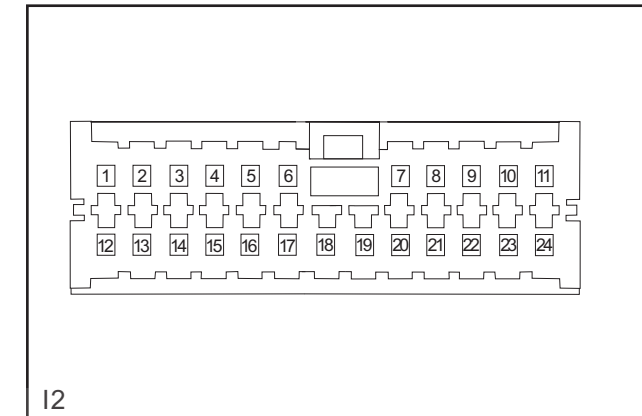

I2 Pin Denifition

Pin Number	Wire Width/Color	Function
1	0.50 Y/W	SRS Indicator
2	- -	
3	0.30 Y/B	Brake Indicator
4	0.50 W/G	ABS Indicator
5	- -	
6	0.30 Y/G	Driver side seat belt switch indicator
7	0.30 R/Y	BCM indicator
8	- -	
9	0.50 B	Ground
10	0.30 W/B	K-line signal
11	- -	
12	0.30 V/W	Low brake fluid level indicator
13	0.30 Gr	LF door lamp signal
14	0.30 Gr/Bl	RF door lamp signal
15	0.30 Gr/G	LR door lamp signal
16	0.30 Gr/Y	RR door lamp signal
17	0.50 R	Background signal
18	0.50 G/Y	Power+
19	0.50 V/B	IGN
20	0.50 V/B	IGN
21	0.50 O/G	Vehicle speed sensor signal
22	0.30 W/Y	Engine speed sensor signal
23	0.50 W/V	Fuel level sensor signal
24	0.50 Br	Coolant temperature signal

Harness Connector View

Instrument Cluster Connector

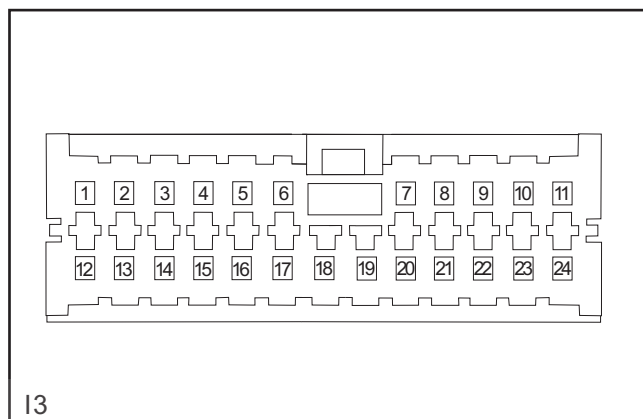

I3

I3 Pin Definition

Pin Number	Wire Width/Color	Function
1	- -	
2	- -	
3	0.30 R/B	Low beam indicator
4	0.30 P/G	High beam indicator
5	0.30 Y/W	Front Fog lamp indicator
6	0.30 G/R	Position lamp indicator
7	0.30 Gr/R	Mode indicator
8	0.85 V/G	Charging indicator
9	0.85 B/W	Low engine oil pressure indicator
10	0.30 G/B	OBD indicator
11	0.30 G/W	Rear fog lamp indicator
12	0.30 Gr/V	Rear trunk lamp switch signal
13	0.30 Br/W	Rear defrosting indicator
14	0.30 G/W	Engine malfunction indicator
15	- -	
16	- -	
17	- -	
18	- -	
19	0.30 R/Y	Turn lamp signal(L)
20	0.30 Br/Y	Turn lamp signal(R)
21	0.50 G	IMMO
22	0.50 B/V	Vehicle speed signal
23	- -	
24	0.50 O/G	Vehicle speed output AT

I/P harness to antenna Connector

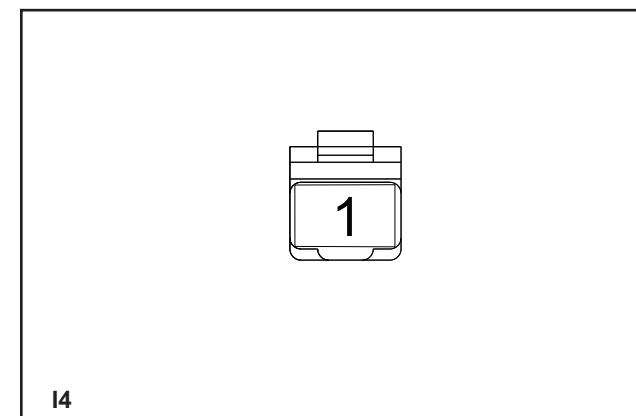

I4

I4 Pin Definition

Pin Number	Wire Width / Color	Function
1	0.50 Y/G	Signal+

CD Connector

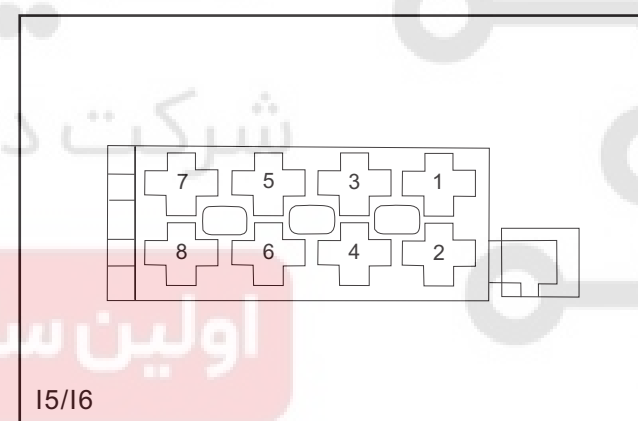

I5/I6

I5 Pin Definition

Pin Number	Wire Width/Color	Function
1	0.30 W/G	Steering wheel switch K1
2	0.30 Y/W	Steering wheel switch K2
3	0.30 Y/B	Reverse DVD
4	0.50 Y/G	PowerACC(+)
5	0.30 R	Background light power(+)
6	0.30 G/Br	Reverse switch
7	0.85 W/Y	Battery(B+)
8	0.50 B	Ground(-)

Harness Connector View

I6 Pin Definition

Pin Number	Wire Width/Color	Function
1	0.30 V	RR speaker+
2	0.30 V/B	RR speaker-
3	0.30 Gr	RF speaker+
4	0.50 Gr/B	RF speaker-
5	0.30 W	LF speaker+
6	0.30 W/B	LF speaker-
7	0.85 Br	LR speaker+
8	0.85 Br/B	LR speaker-

BCM antenna Connector



I7 Pin Definition

Pin Number	Wire Width / Color	Function
1	0.50 W	Signal+

Cigarette lighter Connector

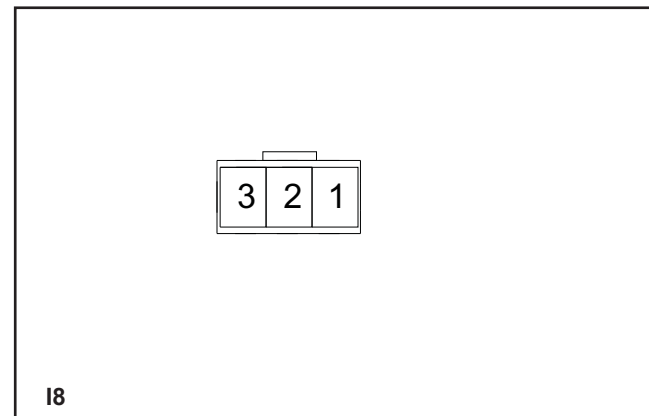

I8 Pin Definition

Pin Number	Wire Width / Color	Function
1	1.25 B	Ground
2	1.25 W/Y	Power
3	0.50 R	Background light

Ashtry light Connector

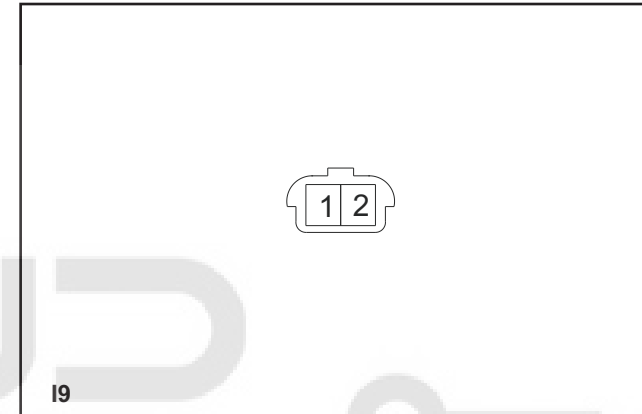

I9 Pin Definition

Pin Number	Wire Width / Color	Function
1	0.50 R	Power
2	0.50 B	Ground

Parking switch Connector

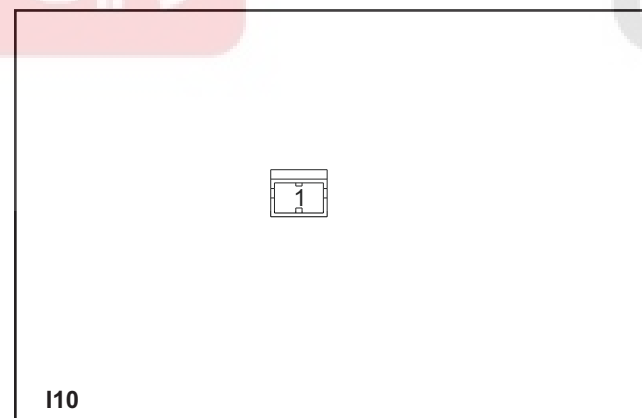

I10 Pin Definition

Pin Number	Wire Width / Color	Function
1	0.50 Y/B	Signal-

Harness Connector View

Rear oxygen sensor Connector

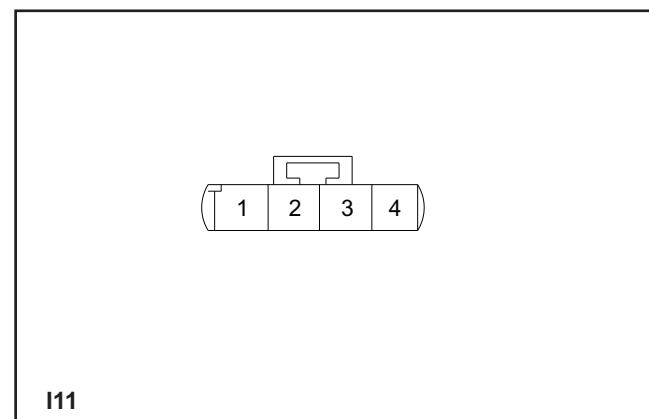

I11 Pin Definition

Pin Number	Wire Width / Color	Function
1	0.5 V/ B	Power
2	0.5 G	Rear oxygen sensor heat control signal
3	0.50 Gr	Rear oxygen sensor signal+
4	1.25 Bl/R	Rear oxygen sensor signal-

Ignition switch Connector



I12 Pin Definition

Pin Number	Wire Width / Color	Function
1	0.50 Y	ACC power
2	3.00 Y/B	IG1 power
3	3.00 Bl	AM1 power
4	3.00 W/Y	AM2 power
5	3.00 W/G	IG2 power
6	1.25 B/Y	Start signal

Key insert switch Connector

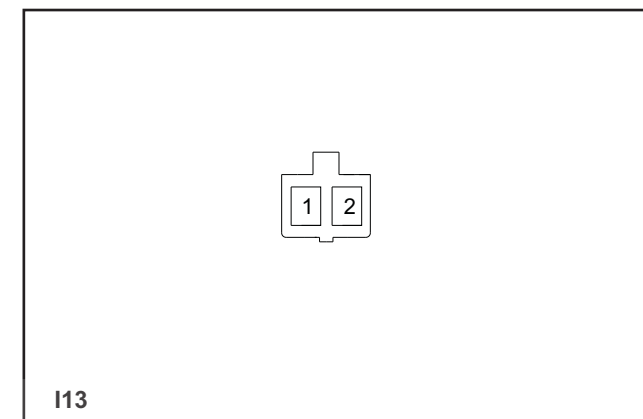

I13 Pin Definition

Pin Number	Wire Width / Color	Function
1	0.50 B/W	Power
2	0.50 B	Ground

Lighting switch connector

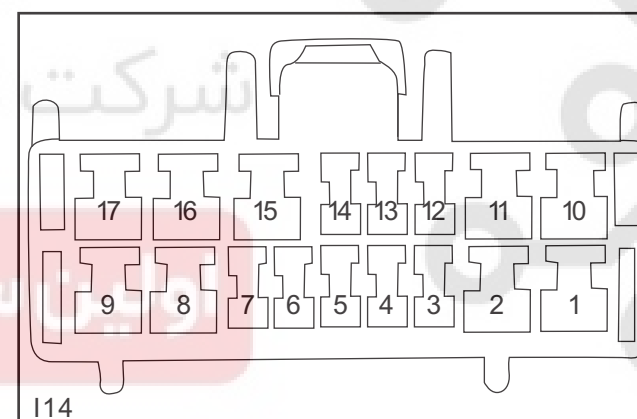

I14 Pin Definition

Pin Number	Wire Width / Color	Function
1	- -	
2	- -	
3	0.30 B	Position lamp control signal
4	0.30 P/Y	Auto signal
5	0.30 P/W	Position lamp signal Control
6	0.30 P/B	Low beam control signal
7	0.30 W/O	Front fog lamp control signal
8	0.50 B	Ground
9	0.30 B/Y	Rear fog lamp control signal
10	0.30 B/R	Overtaking control signal

Harness Connector View

Pin Number	Wire Width / Color	Function
11	0.30 B/G	High beam control signal
12	--	
13	--	
14	--	
15	0.30 Br/B	Right turn lamp control signal
16	0.50 B	Ground
17	0.30 Br/R	Left turn lamp control signal

Wiper switch connector

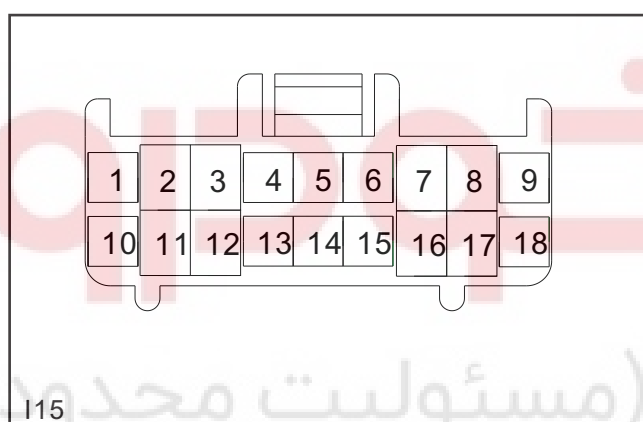

I15 Pin Definition

Pin Number	Wire Width / Color	Function
1	--	
2	0.50 G/B	Washer pump motor
3	1.25 Y/BI	Wiper motor control signal(Low speed)
4	--	
5	--	
6	--	
7	--	
8	0.85 B/BI	Wiper motor control signal(High speed)
9	--	
10	--	
11	--	
12	--	
13	--	
14	0.50 B	Ground
15	--	

16	0.85 Y/G	Wiper motor reset signal
17	1.25 R/B	Wiper motor power
18	--	

Timing coil Connector

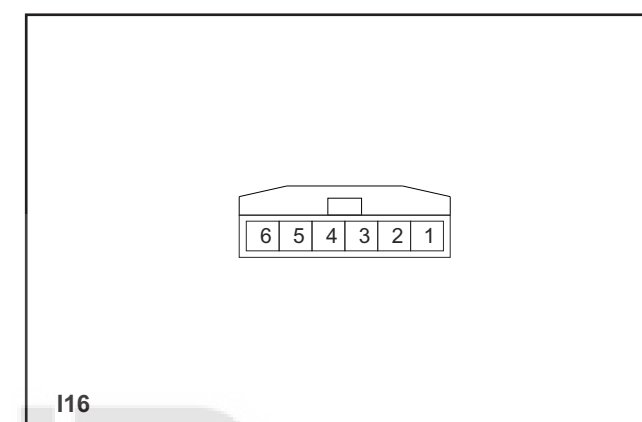

I16 Pin Definition

Pin Number	Wire Width / Color	Function
1	--	
2	0.50 W/G	Steering wheel switch K1
3	0.30 Y/W	Steering wheel switch K2
4	0.50 B	Ground
5	0.50 R	Background light power+
6	0.50 B/Y	Horn signal

Ignition switch coil light Connector

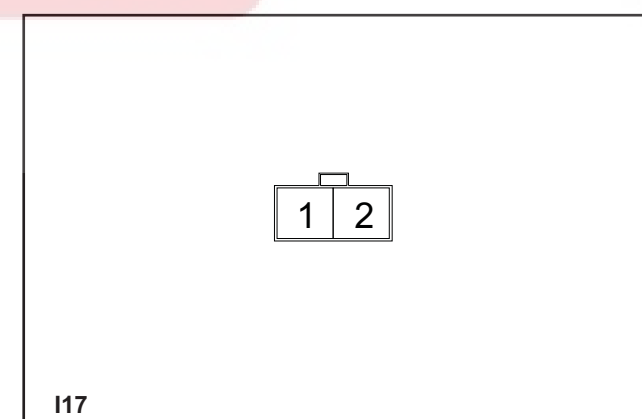

I17 Pin Definition

Pin Number	Wire Width / Color	Function
1	0.5 Y/ G	Signal+
2	0.5 W	Signal-

Harness Connector View

IMMO coil Connector

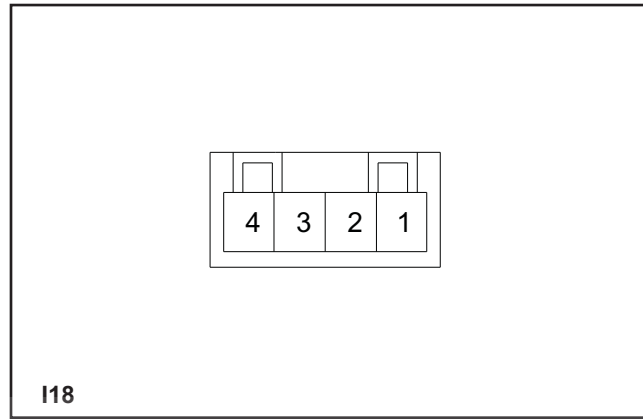

I18 Pin Definition

Pin Number	Wire Width / Color	Function
1	0.50 W	Signal-
2	0.50 Y/G	Signal+
3	0.50 Y	Coil B bottom
4	0.50 BI	Coil A bottom

RF Connector



I19 Pin Definition

Pin Number	Wire Width / Color	Function
1	0.5 Gr/BI	Signal+

Noise filter Connector

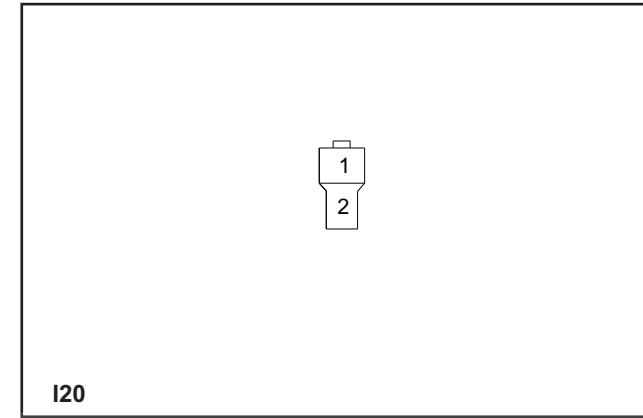

I20 Pin Definition

Pin Number	Wire Width / Color	Function
1	2.00 B/W	Signal+
2	2.00 B	Ground

Brake switch Connector



I21 Pin Definition

Pin Number	Wire Width / Color	Function
1	0.50 G/W	Brake signal
2	0.50 R/W	IG2
3	0.50 G	Brake switch signal
4	0.50 R/W	IG2

Harness Connector View

Headlamp level adjustment switch Connector

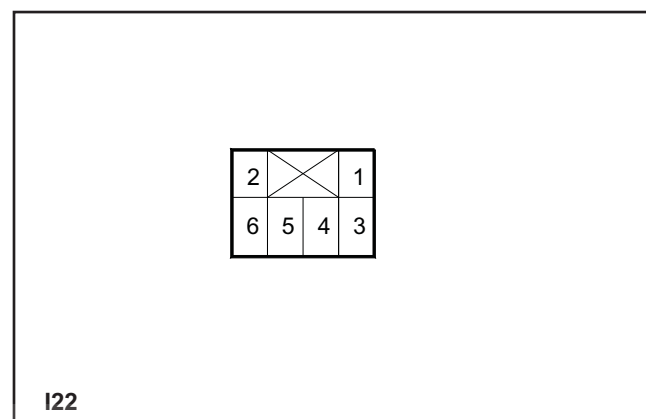

I22 Pin Definition

Pin Number	Wire Width / Color	Function
1	0.50 B	Ground
2	0.50 G/B	Adjustment motor analog signal
3	--	
4	0.50 R	Background light power
5	--	
6	0.50 R/Y	Power

Power rearview mirror switch Connector

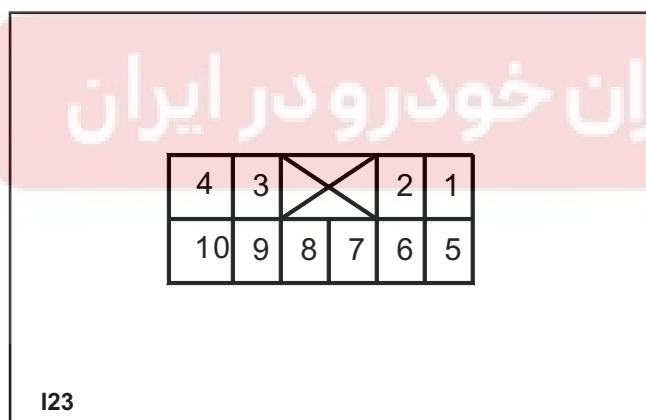

I23 Pin Definition

Pin Number	Wire Width / Color	Function
1	0.50 B	Ground
2	0.50 Br/R	Public bus
3	0.50 B/BI	Power
4	0.50 R	Background light power
5	0.50 BI/R	Left side X direction motor

6	0.50 G/R	Left side Y direction motor
7	--	
8	--	
9	0.50 G/Y	Right side X direction motor
10	0.50 W/BI	Right side Y direction motor

IMMO lamp Connector

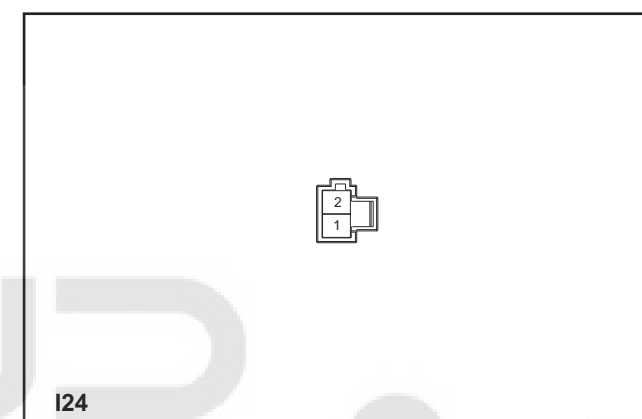

I24 Pin Definition

Pin Number	Wire Width / Color	Function
1	0.50 G/BI	Power
2	0.50 G/B	Signal-

Background light adjustment switch Connector



I25 Pin Definition

Pin Number	Wire Width / Color	Function
1	0.50 R	Power input
2	0.50 G/R	Power output
3	0.50 B	Ground

Harness Connector View

DLC

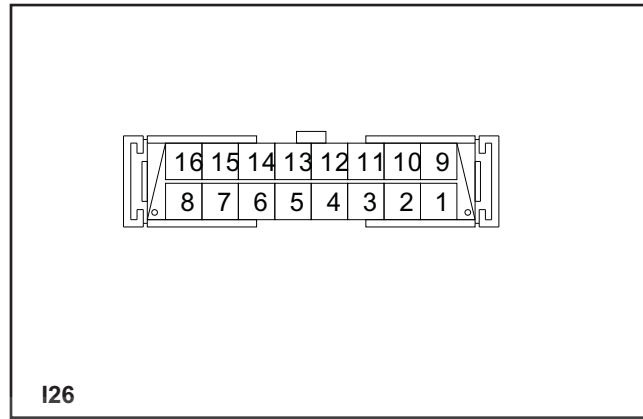

I26

I26 Pin Definition

Pin Number	Wire Width / Color	Function
1	--	
2	--	
3	--	
4	0.50 B	Ground
5	--	
6	0.50 Y/R	CAN-H
7	0.50 V	ECU/IMMO ECU/ABS ECU
8	0.50 V/B	IGN
9	--	
10	--	
11	--	
12	0.50 Br	SRS
13	0.50 W/B	BCM
14	0.50 Y/B	CAN-L
15	--	
16	0.50 W/Y	Power B+

Contact breaker Connector

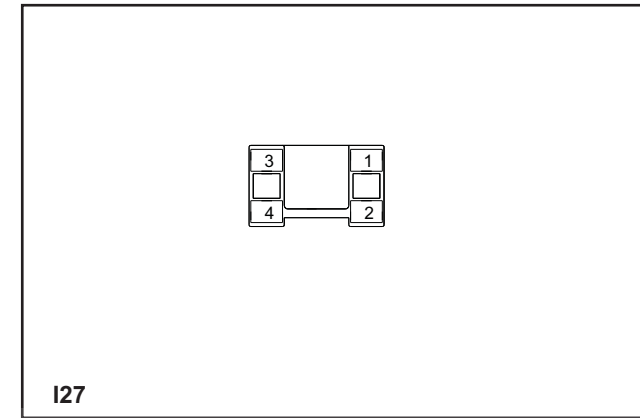

I27

I27 Pin Definition

Pin Number	Wire Width / Color	Function
1	3.00 Y/B	Power 12V
2	3.00 Y	Power 12V
3	3.00 W	Power 12V
4	3.00 W/BI	Power 12V

Harness Connector View

I/P harness to BCM connector

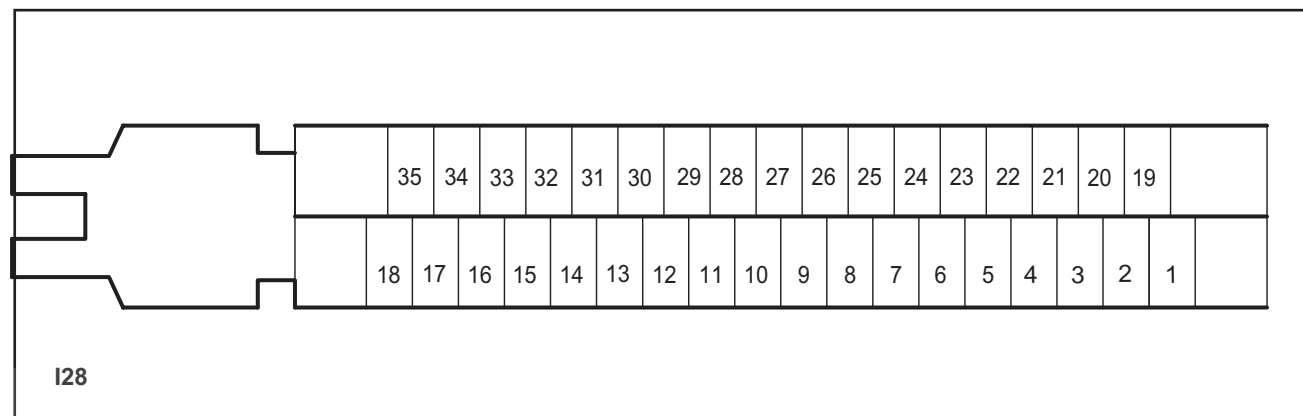

I28 Pin Definition

Pin Number	Color / Wire Width	Function
1	0.50 Gr/G	Power
2	0.50 Y/R	LF lock motor power +
3	0.85 W/BI	LF lock motor power-
4	1.25 B	Ground
5	- -	
6	- -	
7	- -	
8	- -	
9	0.85 B	Ground
10	0.85 B	Ground
11	- -	
12	0.50 V/G	Headlamp control signal
13	0.50 G/W	Anti_theft alarm signal
14	0.50 Br/V	Trunk lock motor signal
15	0.50 G	Position lamp power input
16	0.50 G/Br	Position lamp power output
17	0.50 R/Y	Left turn lamp
18	0.30 Br/Y	Right turn lamp
19	0.50 Br/G	Others lock motor power+
20	0.50 Br/W	Others lock motor power-
21	0.50 Y/R	RR power window motor power -
22	0.55 B/BI	RR power window motor power +
23	2.00 W/R	Power B+

Pin Number	Color / Wire Width	Function
24	0.50 G/B	LR power window motor power -
25	0.50 G/Y	LR power window motor power +
26	- -	
27	0.85 B	Ground
28	0.85 B/G	RF power window motor power -
29	0.50 B/Y	RF power window motor power +
30	- -	
31	- -	
32	2.00 W/R	Power B+
33	0.50 O	Driver side power window motor power -
34	0.85 Gr	Driver side power window motor power +
35	0.85 R/G	Power B+

Harness Connector View

I/P harness to BCM connector

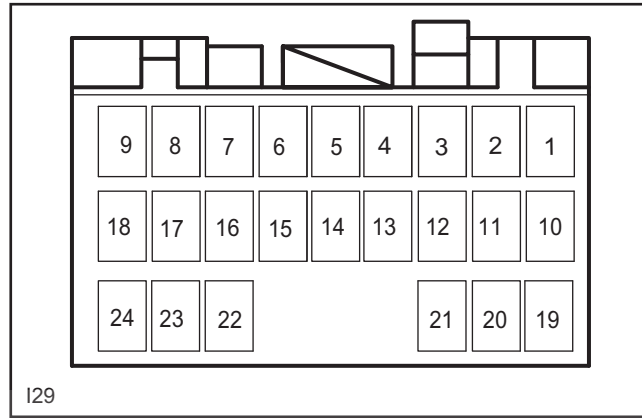

I29

I29 Pin Definition

Pin Number	Color / Wire Width	Function
1	0.50 B/R	Dome lamp signal
2	0.50 Y/G	Signal for ignition switch coil light
3	0.50 G/W	Sunroof control signal
4	0.50 V/G	Fuel relay control signal
5	0.30 B/W	Key insert signal
6	0.50 G/B	IMMO indicator signal
7	0.50 BI/G	Start signal
8	0.30 G/Br	Reverse lamp signal
9	- -	
10	0.50 G/BI	LF lock motor power
11	0.30 Br/B	LF window up signal
12	0.30 Br	LF window down signal
13	0.30 BI/G	RF window up signal
14	0.30 BI/Y	RF window down signal
15	0.30 P/B	LR window up signal
16	0.30 P	LR window down signal
17	0.30 Y/B	RR window up signal
18	0.30 Y	RR window down signal
19	0.30 W/B	DLC signal(K-line)
20	0.50 B/Y	LF lock close signal
21	0.30 Y/G	SRS collision signal
22	0.50 W/Y	LF lock open signal
23	- -	
24	0.50 B	Ground

I/P harness to BCM connector

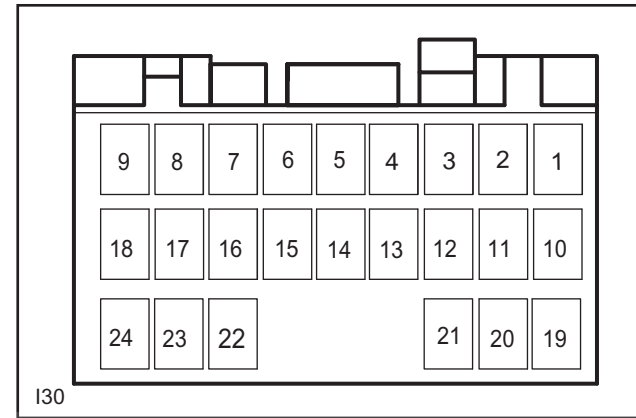

I30

I30 Pin Definition

Pin Number	Color / Wire Width	Function
1	0.50 BI/W	Central control switch open signal
2	0.50 G/BI	Central control switch close signal
3	0.50 G	Auto lock signal
4	0.30 P/W	Position lamp signal
5	0.30 P/B	Low beam signal
6	0.30 P/Y	Auto open low beam signal
7	0.30 B/R	Harzard warning lamp signal
8	0.30 Br/R	Left turn lamp signal
9	0.30 Br/B	Right turn lamp signal
10	0.50 Gr/V	Rear trunk lock signal
11	0.50 Gr	LF door lamp signal
12	0.50 Gr/BI	RF door lamp signal
13	0.50 Gr/G	LR door lamp signal
14	0.50 Gr/Y	RR door lamp signal
15	0.30 V/G	Light sensor signal
16	- -	
17	0.50 W	Antenna signal
18	0.50 R/Y	The distance with other car signal
19	0.50 B/G	LF lock status switch signal
20	0.50 B	Radar detector signal-
21	0.50 G	Radar detector signal+
22	0.50 Y	Radar detector signal 1
23	0.50 R/W	Radar detector signal 2
24	0.50 Y/R	

Harness Connector View

Driver Seat Heat Switch Connector

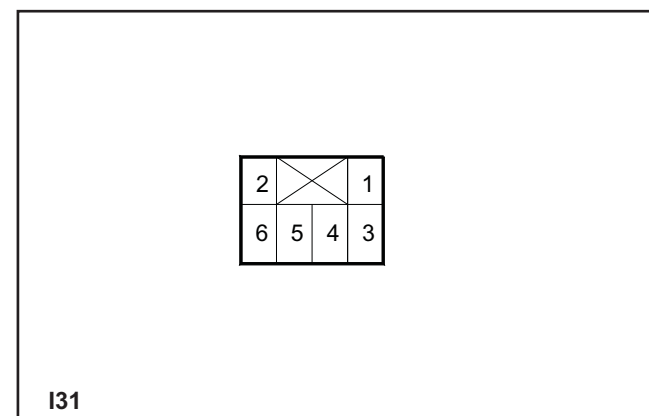

I31 Pin Definition

Pin Number	Wire Width / Color	Function
1	0.50 B	Ground
2	0.50 G	Power 12V
3	0.50 R	Illumination Power
4	- -	
5	0.50 O	Signal
6	- -	

Driver Seat Heat Module Connector



I32

Pin Number	Wire Width / Color	Function
1		
2	0.50 G	Power
3	0.50 B	Ground
4	0.50 O	Signal +

Sun shine sensor Connector

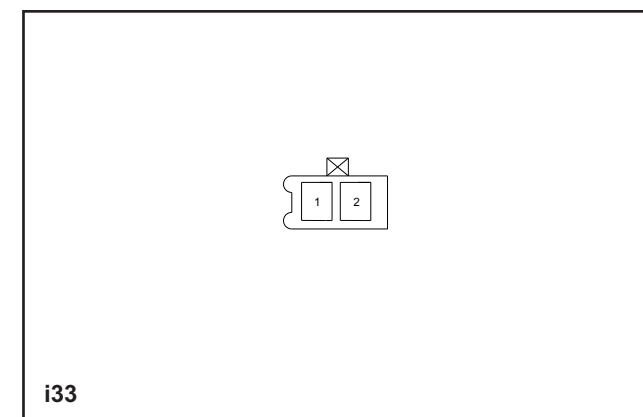

I33 Pin Definition

Pin Number	Wire Width / Color	Function
1	0.05 R	Signal +
2	0.50 B	Ground

I/P harness to IMMO ECU A harness connector

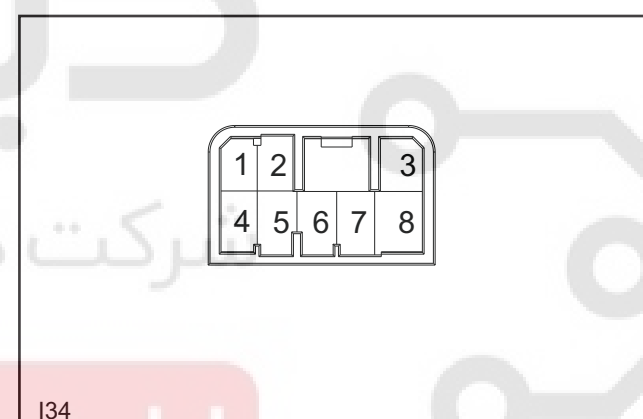

I34 Pin Definition

Pin Number	Color / Wire Width	Function
1	0.50 W/Y	Power B+
2	- -	
3	- -	
4	0.50 B	Ground
5	0.50 BI/G	IGN
6	0.50 Gr/R	Status indicator
7	0.50 P/W	ECU communication application
8	0.50 V	K-line

I/P harness to IMMO ECU B harness connector

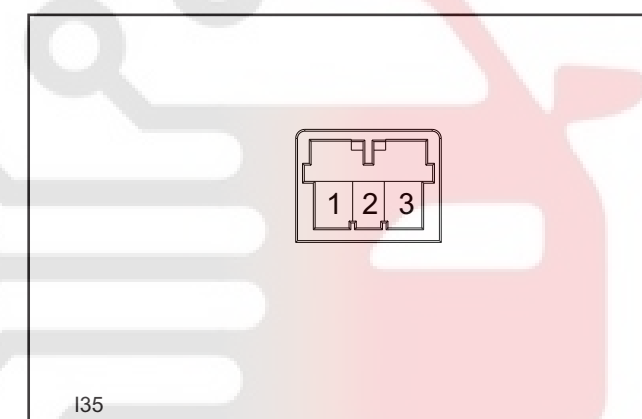

I35 Pin Definition

Pin Number	Color / Wire Width	Function
1	- -	
2	0.50 Y	Coil B bottom
3	0.50 BI	Coil A bottom

Harness Connector View

I/P harness to I/P fuse and relay box harness connector

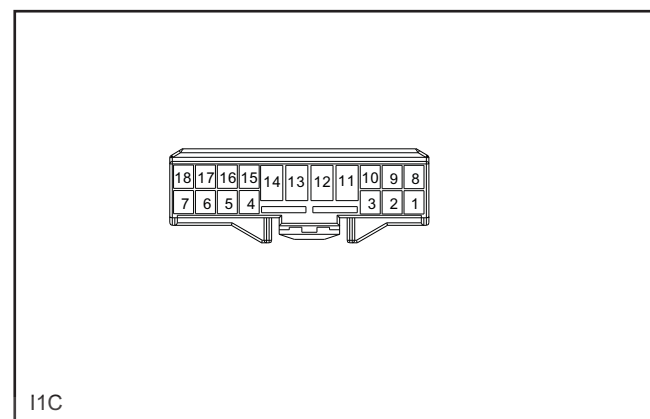

I1C Pin Definition

Pin Number	Color / Wire Width	Function
1	--	
2	--	
3	--	
4	0.50 B/BI	Rearview mirror switch
5	--	
6	0.50 Y/G	CD system power
7	0.85 R/B	Reverse lamp switch signal
8	0.85 R/W	Brake lamp signal
9	0.85 R/Y	SRS ECU
10	0.50 BI/G	BCM start signal
11	--	
12	--	
13	0.85 B/W	ABS start signal
14	3.00 W/Y	IGN AM2
15	--	
16	--	
17	--	
18	--	

I/P harness to I/P fuse and relay box harness connector

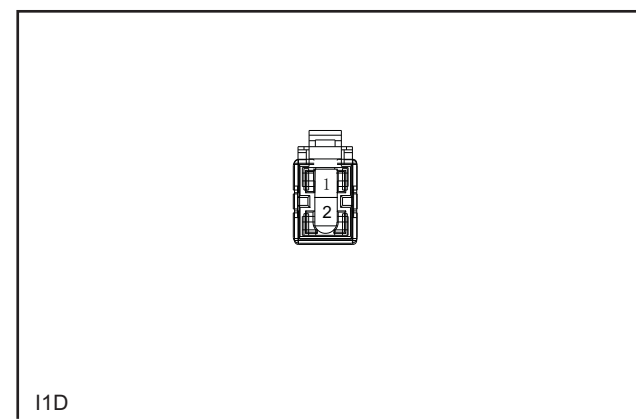

I1D Pin Definition

Pin Number	Color / Wire Width	Function
1	3.00 W/BI	Engine compartment power
2	3.00 Y	Accessory power

I/P harness to I/P fuse and relay box harness connector



I1E Pin Definition

Pin Number	Color / Wire Width	Function
1	--	
2	--	
3	1.25 W/BI	Horn signal
4	1.25 R/B	Wiper controller
5	1.25 G	
6	--	
7	0.85 R/W	Fuel pump
8	0.85 W/Y	CD system/DLC
9	1.25 W/Y	Cigarette lighter
10	1.25 BI	Wiper motor

Harness Connector View

I/P harness to Engine harness connector

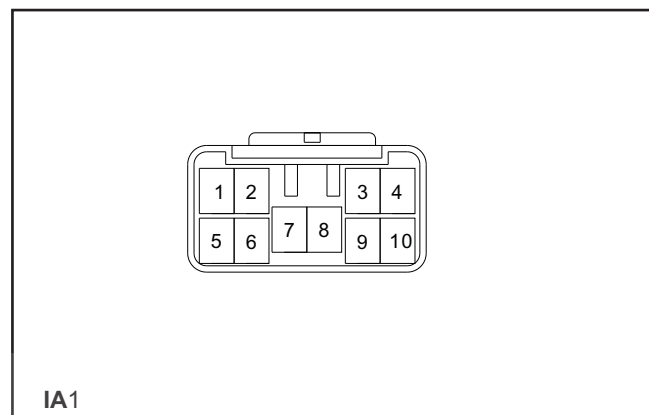

IA1 Pin Definition

Pin Number	Wire Width / Color	Function
1	0.50 R/B	Power
2	0.30 G/Br	Reverse switch signal
3	--	
4	--	
5	1.25 BI/R	Rear oxygen sensor heating
6	2.00 B/W	Fuel pump relay signal
7	--	
8	3.00 B/Y	IGN
9	0.50 Y/B	CAN-L
10	0.50 Y/R	CAN-H

I/P harness to Engine harness connector

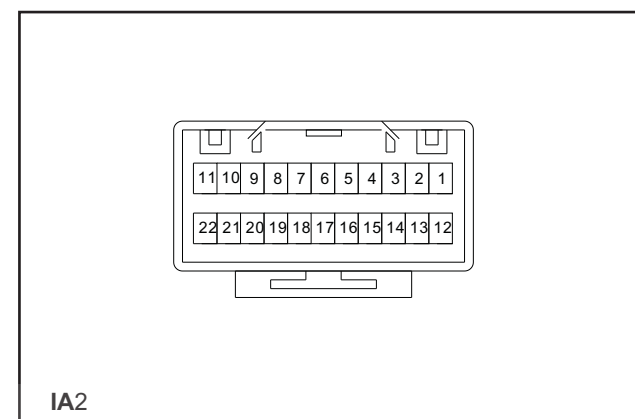

IA2 Pin Definition

Pin Number	Wire Width / Color	Function
1	0.50 P/W	IMMO communication
2	0.50 G	Brake switch signal
3	0.50 G/B	OBD indicator
4	0.85 V/G	Power 12V
5	0.50 B/W	Engine oil pressure signal
6	0.50 Br	Coolant temperature signal
7	--	
8	0.30 G/W	SVS indicator signal
9	0.30 W/Y	Engine speed output signal
10	0.50 Gr	Rear oxygen sensor signal
11	--	
12	0.50 V	K-line
13	0.50 G/W	Brake lamp switch signal
14	0.50 W/V	Coolant temperature sensor signal
15	--	
16	--	
17	0.50 V/B	Front oxygen sensor
18	--	
19	0.50 G	Rear oxygen sensor
20	0.50 B/Y	Fuel pump control signal
21	--	
22	0.50 O/G	Vehicle speed signal

Harness Connector View

I/P harness to Engine Compartment harness connector

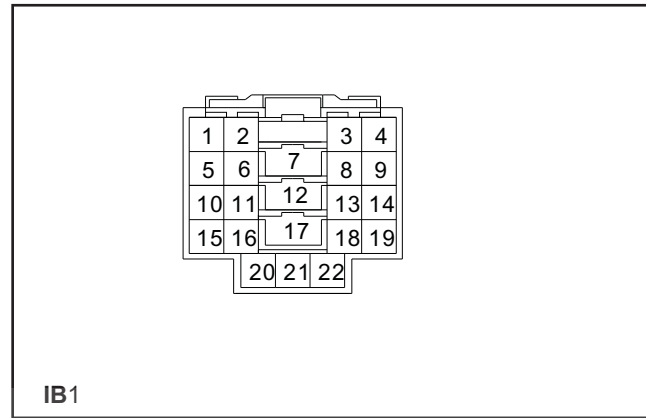

IB1 Pin Definition

Pin Number	Wire Width / Color	Function
1	0.50 V	K-line signal
2	0.30 W/O	Front fog lamp relay
3	0.30 B/G	High beam relay
4	0.30 B/R	Overtaking relay
5	0.50 G/B	Washer pump motor
6	1.25 Y/BI	Wiper motor (Low speed)
7	3.00 Y	Blower power
8	0.50 V/G	Headlamp control signal
9	0.30 G/R	Position lamp signal
10	0.85 B/BI	Wiper motor (High speed)
11	1.25 BI	Compressor power
12	3.00 W	Engine compartment power
13	0.30 P/G	High beam signal
14	0.30 Y/W	Power
15	0.50 R/Y	Turn lamp
16	0.50 Br/Y	LF motor power
17	3.00 Y/B	Power 12V
18	0.50 W/G	ABS indicator
19	0.30 R/B	Low beam signal
20	0.30 V/W	Power
21	1.25 W/BI	Power 12V
22	0.50 Br/G	IG2

I/P harness to Engine Compartment harness connector

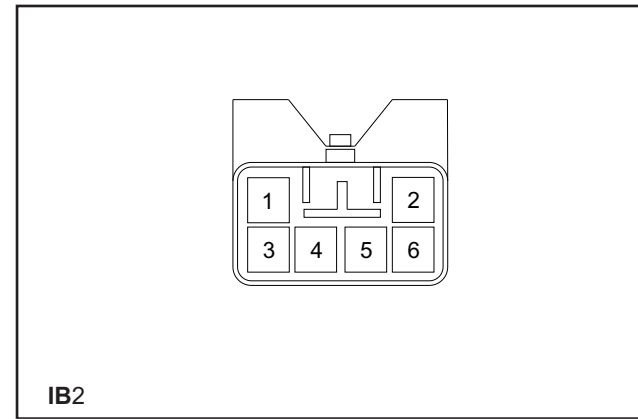

IB2 Pin Definition

Pin Number	Wire Width / Color	Function
1	0.50 G/B	Signal
2	0.85 G/W	Brake signal
3	0.50 B/W	Power+
4	0.50 R/Y	Headlamp level adjustment switch
5	0.85 Y/G	Wiper motor reset
6	0.50 R/G	A/C panel application signal

I/P harness to Engine Compartment harness connector



IB3 Pin Definition

Pin Number	Color / Wire Width	Function
1	--	
2	--	
3	--	
4	0.50 G	Signal+
5	--	
6	--	
7	--	
8	--	

Harness Connector View

I/P harness to Body harness connector

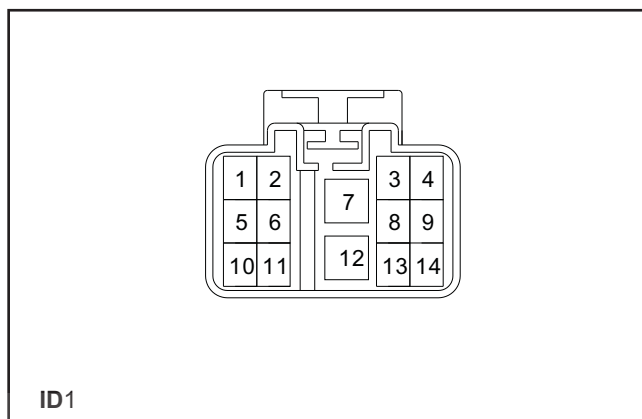

ID1 Pin Definition

Pin Number	Wire Width / Color	Function
1	0.85 G/Br	Reverse lamp signal
2	0.50 G/W	Brake signal
3	0.50 Br/B	LR speaker
4	0.50 Br	LR speaker
5	0.50 Gr/G	LR door lamp signal
6	0.50 Gr/V	Rear trunk lock signal
7	0.30 P	LR window power-
8	0.50 V	RR speaker
9	0.50 V/B	RR speaker
10	0.50 W/V	Coolant temperature sensor signal
11	0.50 Bl/W	Compressor power
12	0.30 P/B	LR window power-
13	0.30 Br/Y	Right turn lamp
14	0.50 R/Y	Left turn lamp

I/P harness to Body harness connector

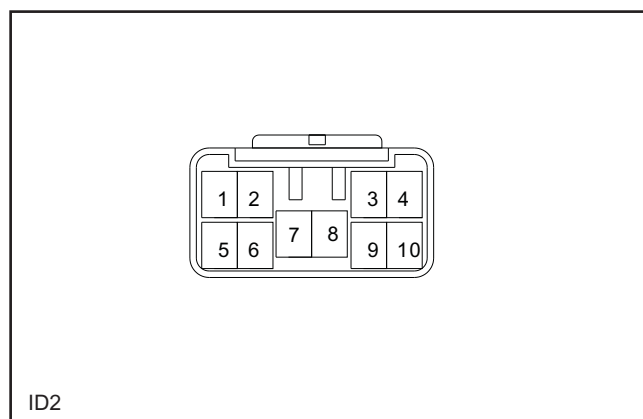

ID2 Pin Definition

Pin Number	Wire Width / Color	Function
1	0.50 G	Radar detector signal+
2	0.50 R/W	Radar detector signal 2
3	0.50 Y	Radar detector signal 1
4	0.50 Y/R	
5	0.50 Br/G	Others lock motor power+
6	0.50 Br/W	Others lock motor power-
7	0.85 G/R	Position lamp power output
8	2.00 Br	Power 12V
9	--	
10	0.85 G/Y	LR window power+

I/P harness to Body harness connector

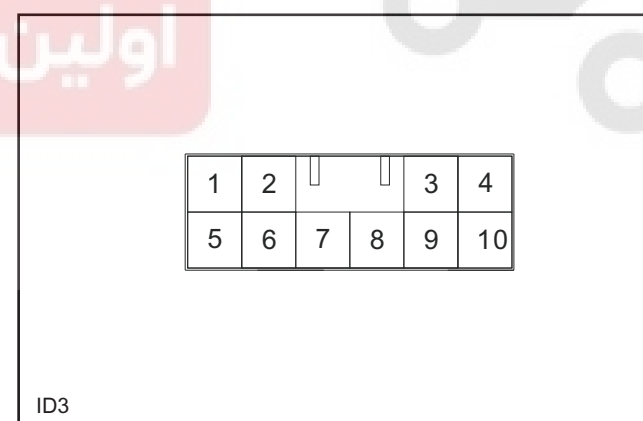

Harness Connector View

ID3 Pin Definition

Pin Number	Wire Width / Color	Function
1	0.50 Br/V	Rear trunk lock
2	0.50 G/W	Anti-Theft alarm power output
3	0.50 R	Background light power input
4	0.30 G	Safety lock(Children lock) switch
5	0.50 B	Radar detector signal-
6	0.50 G	Power+
7	0.50 Gr/Y	RR door lamp signal
8	0.50 Gr	LF door lamp signal
9	0.85 R/W	Power+
10	0.85 G/B	LR window power-

I/P harness to Roof harness connector

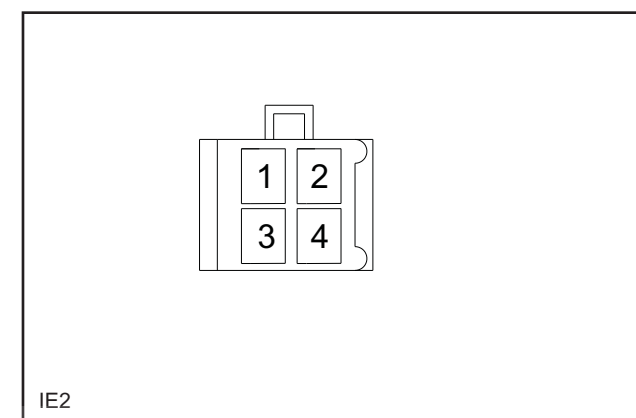

IE2 Pin Definition

Pin Number	Color / Wire Width	Function
1	0.50 Y/G	Signal+
2	0.50 G/W	Signal-
3	--	
4	1.25 Gr	Signal-

I/P harness to SRS harness Connector



IF Pin Definition

Pin Number	Color / Wire Width	Function
1	0.30 Y/G	Driver side safety belt alarm signal input
2	0.30 Y/G	Collision signal output
3	--	
4	--	
5	--	
6	0.30 Br	K-line
7	0.50 Y/W	SRS indicator
8	0.85 R/Y	Power B+
9	--	
10	--	

I/P harness to Roof harness connector



IE Pin Definition

Pin Number	Color / Wire Width	Function
1	0.50 W/R	Power
2	1.25 B	Ground
3	--	
4	0.50 B/R	Dome lamp signal

Harness Connector View

I/P harness to HAVC harness connector

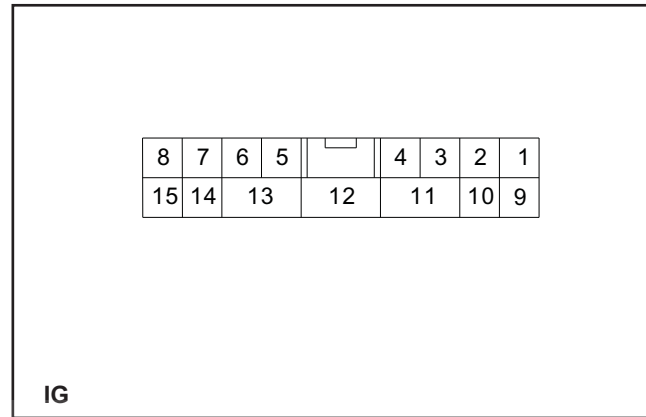

IG Pin Definition

Pin Number	Wire Width / Color	Function
1	0.50 G/BI	Cetral control switch close signal
2	0.50 Br/B	ACC power
3	0.85 Br/G	IGN2
4	0.30 B/R	Hazard warning lamp signal
5	--	
6	0.50 R	Illumination power
7	0.50 G/R	Position lamp signal input
8	0.50 R/G	A/C panel application signal
9	0.30 W/B	Ground
10	0.50 R/Y	Left turn lamp
11	3.00 B	Ground
12	0.85 Br/G	IGN2
13	3.00 Y	Blower motor B+
14	0.50 BI/W	Central control switch open signal
15	0.85 B	Ground

I/P harness to HAVC harness connector

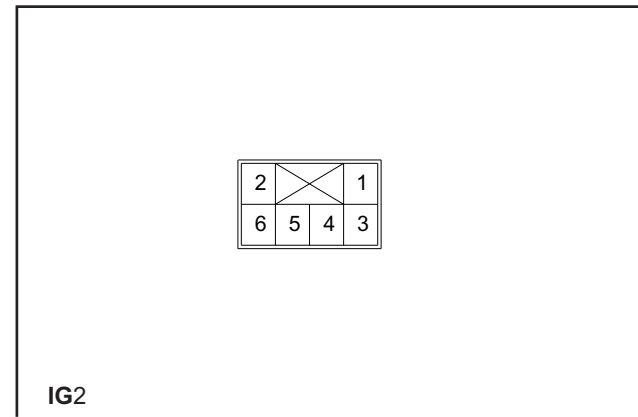

IG2 Pin Definition

Pin Number	Wire Width / Color	Function
1	0.50 R	Signal+
2	0.30 G	Signal+
3	0.50 O/G	Vehicle speed sensor output (AT)
4	--	
5	--	
6	0.50 B/R	Vehicle speed signal

Harness Connector View

I/P harness to Door harness(LF) Connector

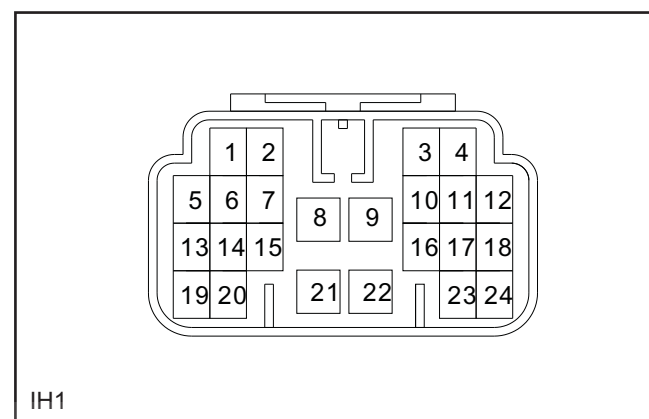

IH1 Pin Definition

Pin Number	Wire Width / Color	Function
1	0.50 W	LF speaker
2	0.50 W/B	LF speaker
3	0.30 Bl/Y	RF window down signal
4	0.30 Y	RR window down signal
5	0.30 Bl/G	RF window up signal
6	0.50 Bl/R	Left rearview mirror X direction motor
7	0.50 G/R	Left rearview mirror Y direction motor
8	0.50 Y/G	Power ACC
9	0.50 Gr	LF window up signal
10	0.30 P	LR window down signal
11	0.30 P/B	LR window up signal
12	0.30 Y/B	RR window up signal
13	0.30 Br/B	LF window up signal
14	0.85 O	LF window down signal
15	0.30 Br	LF window down signal
16	0.50 W/Bl	LF lock motor power-
17	0.30 G	Safety lock(Children lock) switch
18	0.50 Y/R	LF lock motor power+
19	0.50 W/Y	LF lock motor power+
20	0.50 W/Y	LF lock motor power-
21	0.85 Br/V	Power
22	--	
23	0.85 B	Ground
24	0.50 B/G	LF lock status switch signal

I/P harness to Door harness(LF) connector

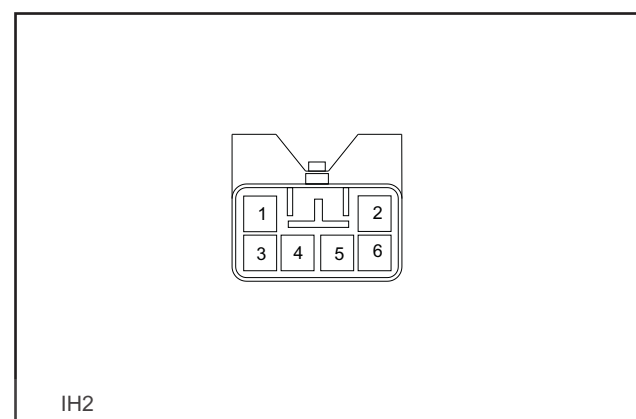

IH2 Pin Definition

Pin Number	Wire Width / Color	Function
1	0.50 R/Bl	Power 12V
2	0.50 Br/R	Public wire
3	0.50 R/Y	Left turn lamp
4	0.50 R	Illumination power
5	--	
6	0.50 Gr	LF door lamp signal

Harness Connector View

Body Harness Connector(B--)

LF Door Lamp Connector

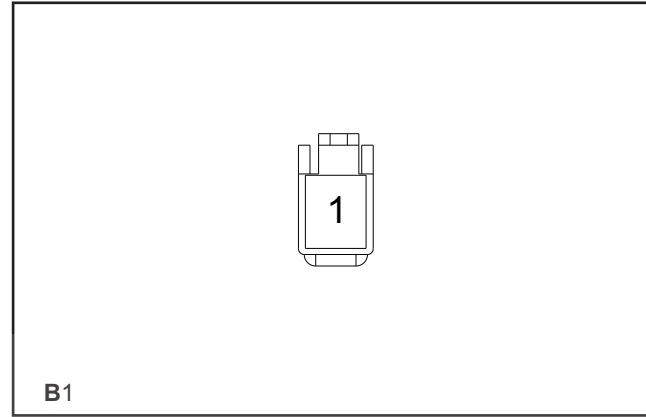

B1 Pin Definition

Pin Number	Wire Width / Color	Function
1	0.50 Gr	Power

Body Harness to Fuel Pump Connector

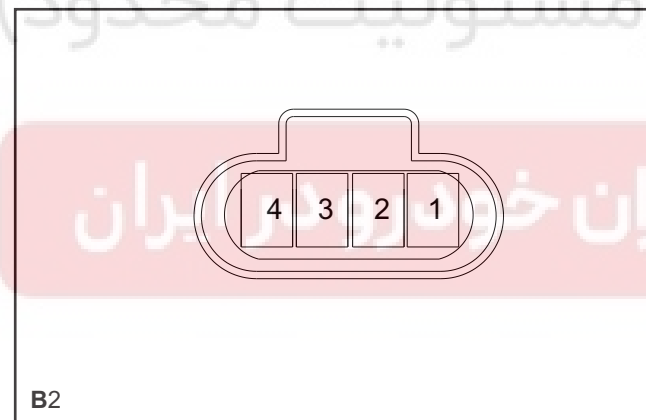

B2 Pin Definition

Pin Number	Wire Width / Color	Function
1	0.85 R/W	12V power
2	0.50 W/V	Fuel level sensor signal
3	0.50 B	Ground
4	0.85 B	Ground

RR Wheel Speed Sensor Connector

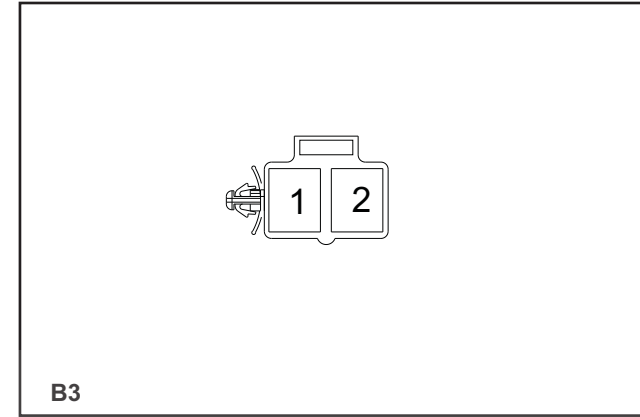

B3 Pin Definition

Pin Number	Wire Width / Color	Function
1	0.50 Y/B	Signal+
2	0.50 Y	Signal-

RR Door Lamp Connector



B4 Pin Definition

Pin Number	Wire Width / Color	Function
1	0.50 Gr/Y	Power

Harness Connector View

LR Wheel Speed Sensor Connector

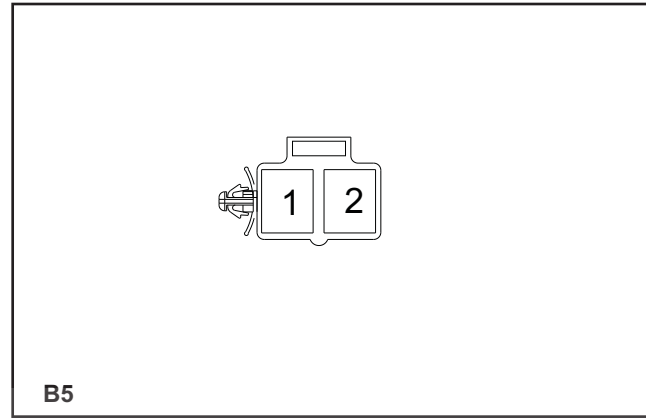

License Lamp Connector

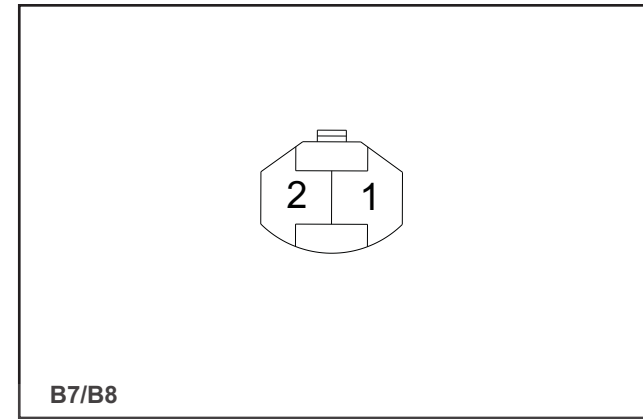

B5 Pin Definition

Pin Number	Wire Width / Color	Function
1	0.50 P/B	Signal-
2	0.50 P	Signal+

B7/B8 Pin Definition

Pin Number	Wire Width / Color	Function
1	0.50 G/R	Power
2	0.50 B	Ground

LR Door Lamp Connector



Immobilizer Speaker Connector

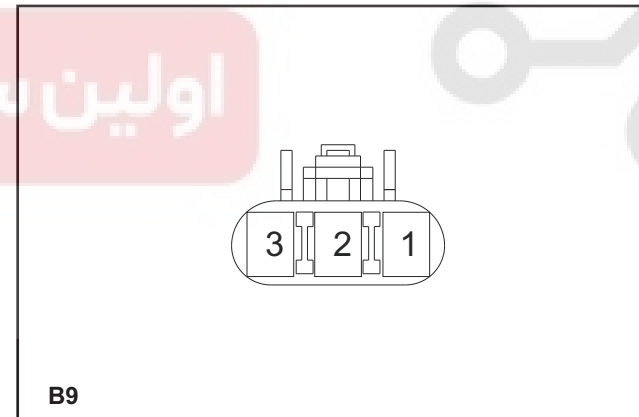

B6 Pin Definition

Pin Number	Wire Width / Color	Function
1	0.50 Gr/G	Power

B9 Pin Definition

Pin Number	Wire Width / Color	Function
1	0.50 G/W	Power
2	--	
3	0.50 B	Ground

Harness Connector View

LR assy. Lamp Connector

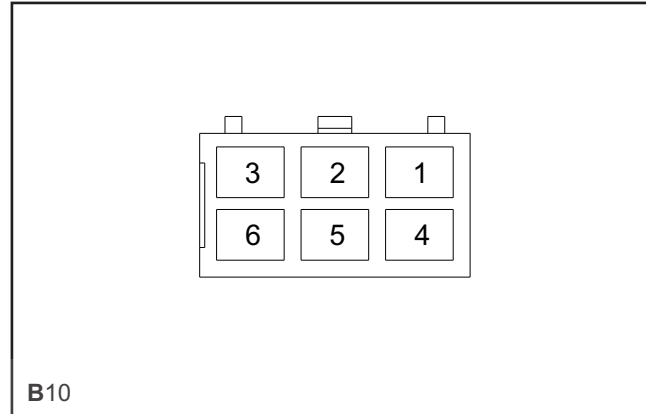

B10 Pin Definition

Pin Number	Wire Width / Color	Function
1	0.50 R/Y	Turn lamp
2	1.25 B	Ground
3	0.85 G/R	Position lamp
4	0.50 G	Rear fog lamp
5	0.50 G/W	Brake lamp
6	0.50 G/Br	Reverse lamp

Rear Trunk Lamp Switch Connector



B11 Pin Definition

Pin Number	Wire Width / Color	Function
1	0.50 Gr/V	Power

RR assy. Lamp Connector

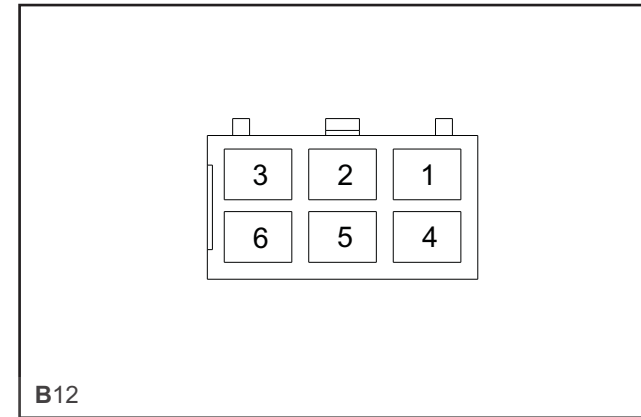

B12 Pin Definition

Pin Number	Wire Width / Color	Function
1	0.50 Br/Y	Turn lamp
2	1.25 B	Ground
3	0.85 G/R	Position lamp
4	0.50 G	Rear fog lamp
5	0.50 G/W	Brake lamp
6	0.50 G/Br	Reverse lamp

Noise Filter Connector



B13 Pin Definition

Pin Number	Wire Width / Color	Function
1	--	
2	0.50 Br	Power

Harness Connector View

LR/RR Speaker Connector

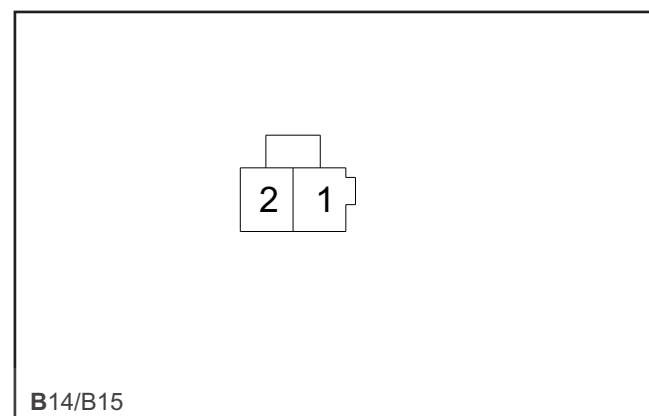

B14 Pin Definition

Pin Number	Wire Width / Color	Function
1	0.50 Br/B	Ground
2	0.50 Br	Power

B15 Pin Definition

Pin Number	Wire Width / Color	Function
1	0.50 V/B	Ground
2	0.50 V	Power

Rear Trunk Lamp Connector



B16 Pin Definition

Pin Number	Wire Width / Color	Function
1	0.50 Bl/W	Power
2	0.50 Gr/V	Ground

High Mounted Brake Connector

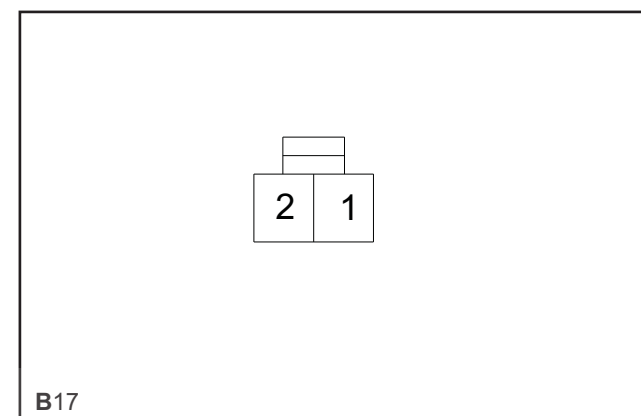

B17 Pin Definition

Pin Number	Wire Width / Color	Function
1	0.50 G/W	Power
2	0.85 B	Ground

Body harness to Reverse Radar harness Connector



BH1 Pin Definition

Pin Number	Wire Width / Color	Function
1	0.50 G	Signal+
2	0.50 B	Signal-
3	--	
4	0.50 Y/R	
5	0.50 Y	Radar detector 1
6	0.50 R/W	Radar detector signal 2

Harness Connector View

Defroster Connector

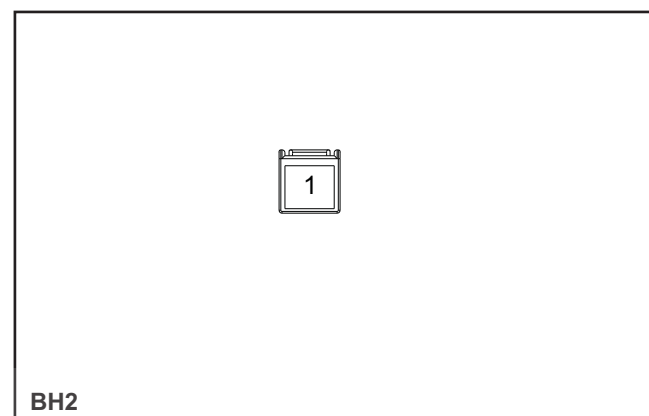

BH2 Pin Definition

Pin Number	Wire Width / Color	Function
1	2.00 Br	Power

Rear Trunk Electronic Lock Connector



B20 Pin Definition

Pin Number	Wire Width / Color	Function
1	--	
2	0.50 B	Ground
3	0.50 Br/V	Power

Body harness to I/P harness Connector

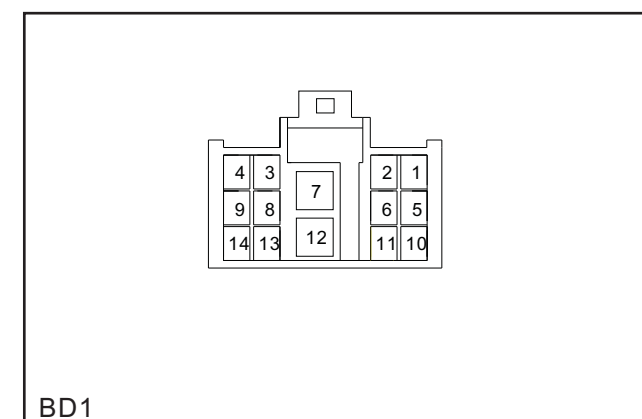

BD1 Pin Definition

Pin number	Wire Width/Color	Function
1	0.85 G/Br	Reverse lamp signal
2	0.50 G/W	Brake signal
3	0.50 Br/B	LR speaker
4	0.50 Br	LR speaker
5	0.50 Gr/G	LR door lamp signal
6	0.50 Gr/V	Rear trunk lock signal
7	0.30 P	LR window power-
8	0.50 V	RR speaker
9	0.50 V/B	RR speaker
10	0.50 W/V	Coolant temperature sensor signal
11	0.50 BI/W	Compressor power
12	0.30 P/B	LR window power-
13	0.30 Br/Y	Right turn lamp
14	0.50 R/Y	Left turn lamp

Harness Connector View

Body harness to I/P harness Connector

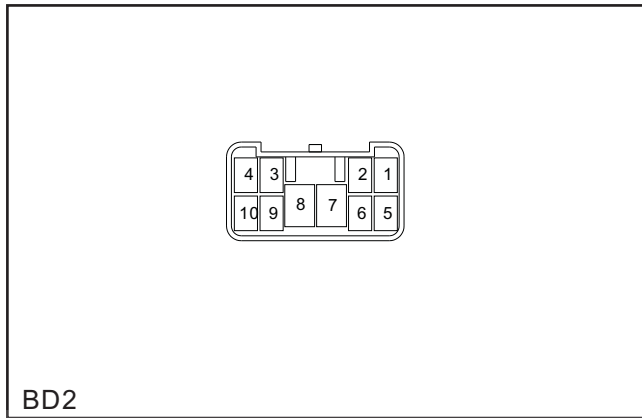

BD2 Pin Definition

Pin number	Wire Width/Color	Function
1	0.50 G	
2	0.50 R//W	Radar detector signal 1
3	0.50 Y	Radar detector signal 2
4	0.50 Y/R	Radar detector signal+
5	0.50 Br/G	Others lock motor power+
6	0.50 Br/W	Others lock motor power-
7	0.85 G/R	Position lamp power output
8	2.00 Br	
9	0.30 W/Y	
10	0.85 G/Y	LR window power+

Body harness to I/P harness connector

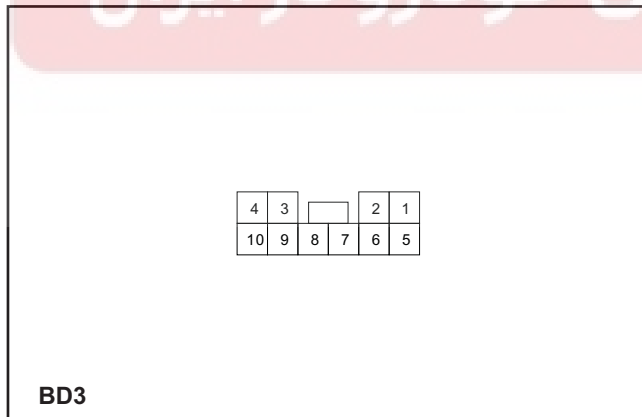

BD3 Pin Definition

Pin Number	Wire Width / Color	Function
1	0.50 Br/V	Rear trunk lock
2	0.50 G/W	Anti-Theft alarm power output
3	0.30 R	Background light power input

Pin Number	Wire Width/Color	Function
4	0.30 G	Safety lock(Children lock) switch
5	0.50 B	Radar detector signal-
6	0.85 G	Power+
7	0.50 Gr/Y	RR door lamp signal
8	0.50 Gr	LF door lamp signal
9	0.85 R/W	Power+
10	0.85 G/B	LR window power-

Body harness to Engine Compartment harness connector



BA Pin Definition

Pin Number	Wire Width / Color	Function
1	0.50 P	Wheel speed sensor(LR) signal+
2	0.50 P/B	Wheel speed sensor(LR) signal-
3	0.50 Y	Wheel speed sensor(RR) signal-
4	0.50 Y/B	Wheel speed sensor(RR) signal+

Harness Connector View

Body harness to Door harness(LR) connector

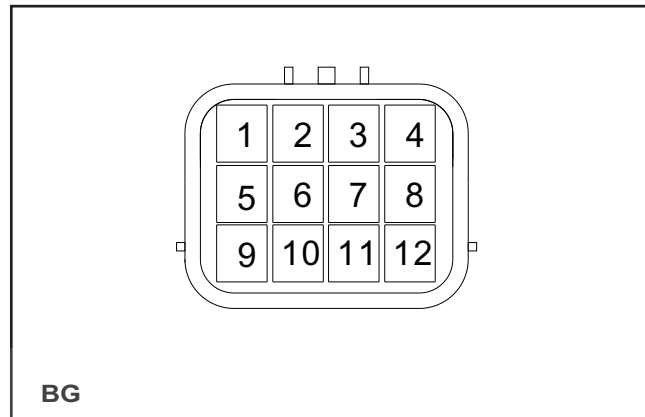

BG Pin Definition

Pin Number	Wire Width / Color	Function
1	0.50 G	Safety lock(Children lock) switch
2	0.50 B	Ground
3	0.50 G/Y	LR power window up signal
4	0.85 G/B	LR power window down signal
5	0.50 P	LR power window down signal
6	0.50 Gr/G	LR door lamp power 12V
7	--	
8	0.50 BI/W	Power 12V
9	0.50 R	LR power window down signal
10	0.50 P/B	LR power window up signal
11	0.50 Br/W	Other lock power-
12	0.50 Br/G	Other lock power+



Harness Connector View

Door Harness Connector (D--)

D1 Drive Power Window

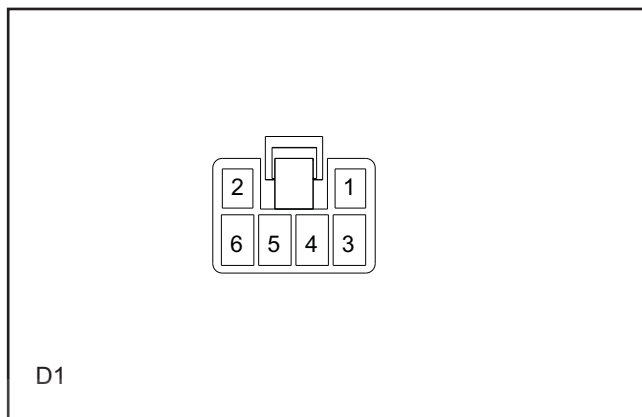

D1 Pin Definition

Pin Number	Wire Width / Color	Function
1	--	
2	--	
3	--	
4	0.85 O	LF window up signal
5	0.85 Gr	LF window down signal
6	--	

D2 Power Rearview

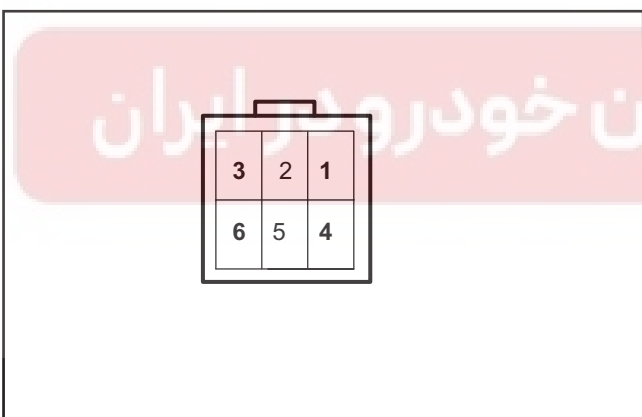

D2 Pin Definition

Pin Number	Wire Width / Color	Function
1	0.50 Bl/R	Left rearview mirror X direction motor
2	0.85 Br/V	Defroster power
3	0.50 R/Y	Left turn lamp
4	0.50 G/R	Left rearview mirror Y direction motor
5	0.50 Br/R	Public wire
6	0.50 B	Ground

High Loudspeaker Connector

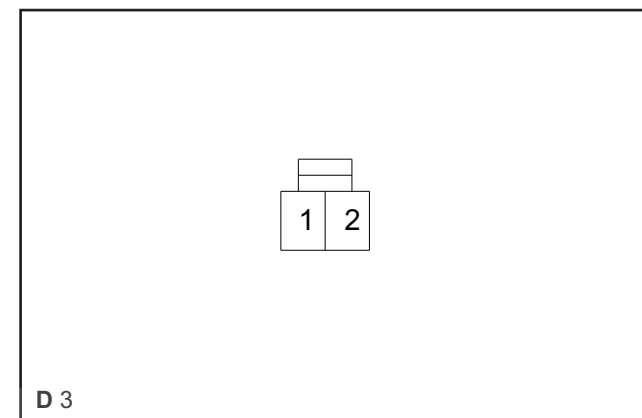

D3 Pin Definition

Pin Number	Wire Width / Color	Function
1	0.50 W	Power +
2	0.50 W/B	Power -

Left Speaker Connector



D4 Pin Definition

Pin Number	Wire Width / Color	Function
1	0.50 W/B	Power -
2	0.50 W	Power +

Harness Connector View

Driver Side Power Window Swith Connector

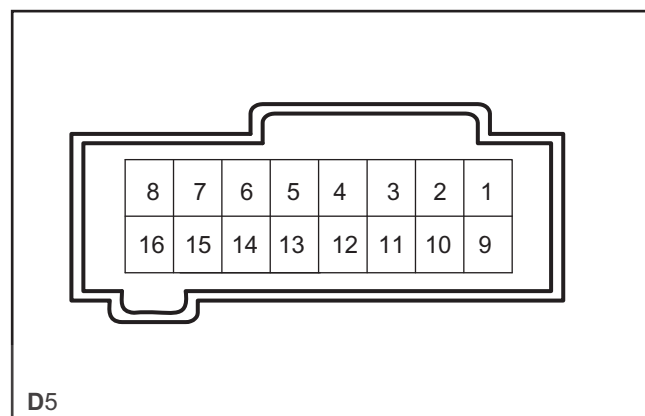

D5 Pin Definition

Pin Number	Wire Width / Color	Function
1	0.50 Br	LF window down signal
2	0.50 Br/B	LF window up signal
3	0.50 G/Y	ACC signal
4	--	
5	--	
6	0.50 G	Safety lock signal
7	0.50 P	LR window down signal
8	0.50 P/B	LR window up signal
9	0.50 BI/Y	RF window down signal
10	0.50 BI/G	RF window up signal
11	0.50 R	
12	--	
13	0.50 B	Ground
14	--	
15	0.50 Y	RR window down signal
16	0.50 Y/B	RR window up signal

LF Door Lamp Connector

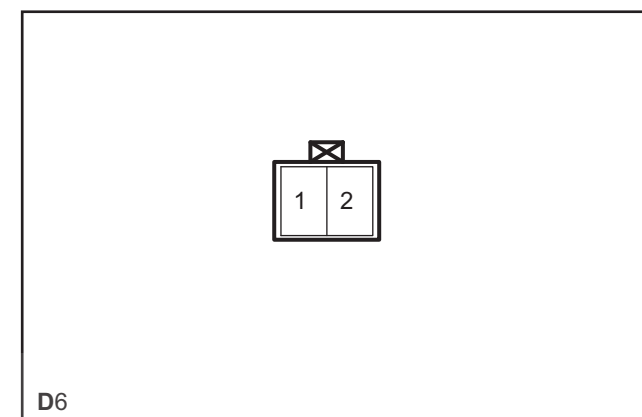

D6 Pin Definition

Pin Number	Wire Width / Color	Function
1	0.50 Gr	LF door lamp signal
2	0.50 R/BI	Power 12V

LR Lock Motor Connector



D7 Pin Definition

Pin Number	Wire Width / Color	Function
1	0.50 W/BI	LF lock motor power -
2	0.50 Y/R	LF lock motor power +
3	0.50 B/Y	Central lock Close signal
4	0.50 W/Y	Central lock open signal
5	0.50 B	Ground
6	0.50 B/G	LF lock status signal

Harness Connector View

RF Power Window

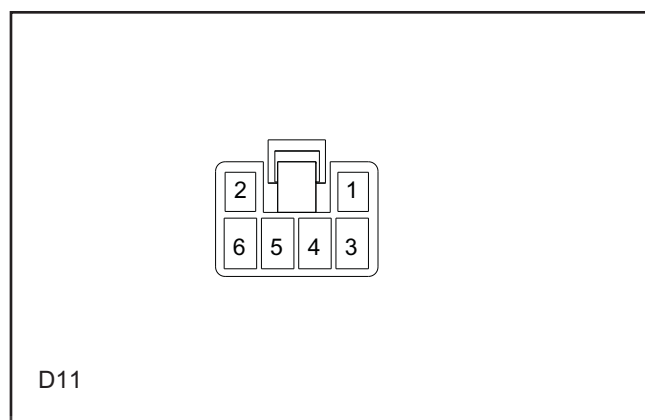

D11 Pin Definition

Pin Number	Wire Width / Color	Function
1	--	
2	--	
3	--	
4	0.85 B/G	RF window up signal
5	0.85 B/Y	RF window down signal
6	--	

Power Rearview mirror(R) connector

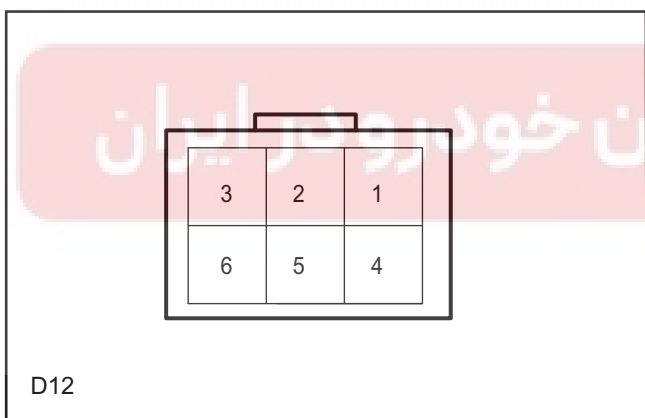

D12 Pin Definition

Pin Number	Wire Width / Color	Function
1	0.50 W/Bl	Right rearview mirror X direction motor
2	0.85 Br/V	Defroster power
3	0.30 Br/Y	Right turn lamp
4	0.50 G/Y	Right rearview mirror Y direction motor
5	0.50 Br/R	Public wire
6	0.50 B	Ground

High Loudspeaker Connector

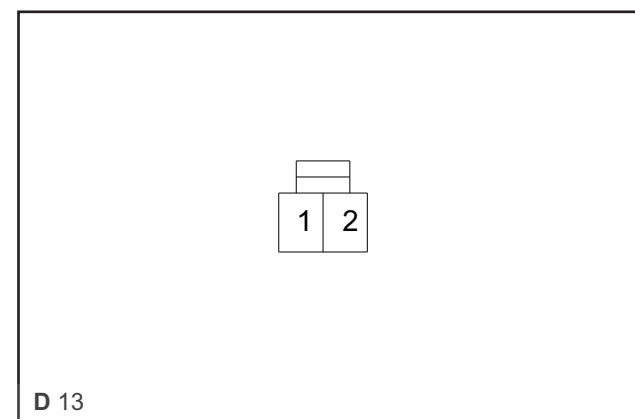

D13 Pin Definition

Pin Number	Wire Width / Color	Function
1	0.50 Gr	Power +
2	0.50 Gr/W	Power -

Right Speaker Connector



D14 Pin Definition

Pin Number	Wire Width / Color	Function
1	0.50 Gr/W	Power -
2	0.50 Gr	Power +

Harness Connector View

RF Power Window Switch Connector

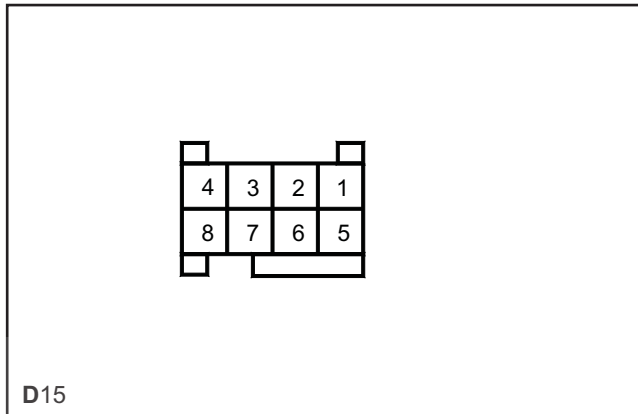

D15 Pin Definition

Pin Number	Wire Width / Color	Function
1	0.50 BI/G	RF window up signal
2	--	
3	--	
4	--	
5	0.50 G	Safety lock signal
6	0.50 B	Ground
7	0.50 BI/Y	RF window down signal
8	0.50 R	Illumination Power

RF Door Lamp Connector

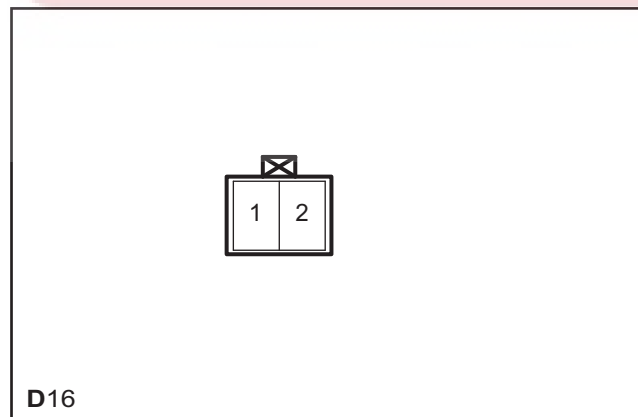

D16 Pin Definition

Pin Number	Wire Width / Color	Function
1	0.50 Gr/BI	RF door lamp signal
2	0.50 R/BI	Power 12V

RF Lock Motor Connector

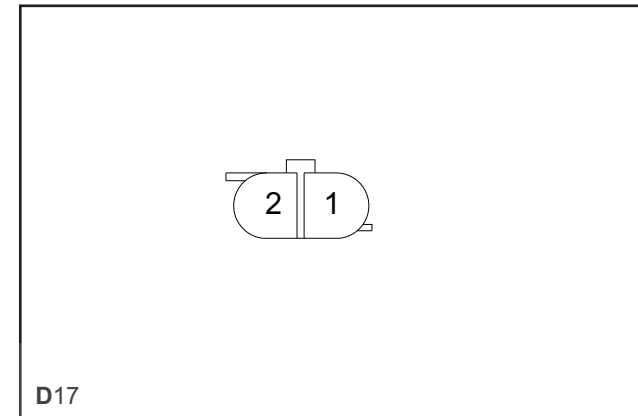

D17 Pin Definition

Pin Number	Wire Width / Color	Function
1	0.50 Br/P	Power -
2	0.50 Br/V	Power +

Harness Connector View

LR Power Window

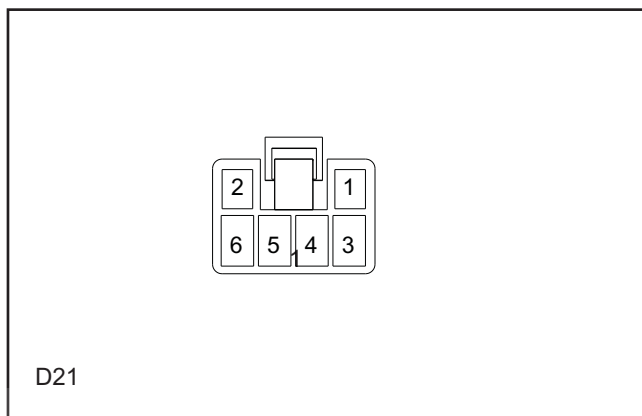

D21 Pin Definition

Pin Number	Wire Width / Color	Function
1	--	
2	--	
3	--	
4	0.85 G/Y	LR window up signal
5	0.85 G/B	LR window down signal
6	--	

LR Power Window Switch Connector

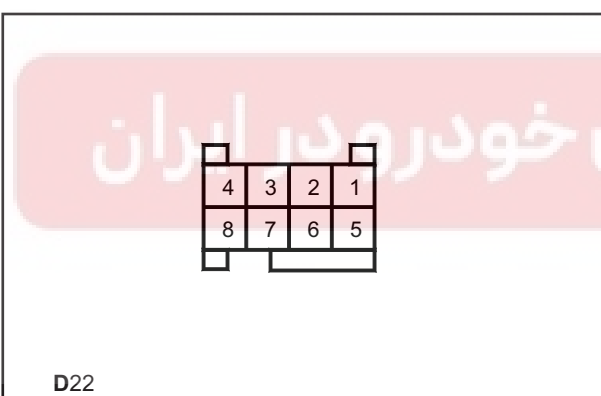

D22 Pin Definition

Pin Number	Wire Width / Color	Function
1	0.50 P/B	LR window up signal
2	--	
3	--	
4	--	
5	0.50 G	Safety lock signal
6	0.50 B	Ground
7	0.50 P	LR window down signal
8	0.50 R	Illumination Power

LR Door Lamp Connector

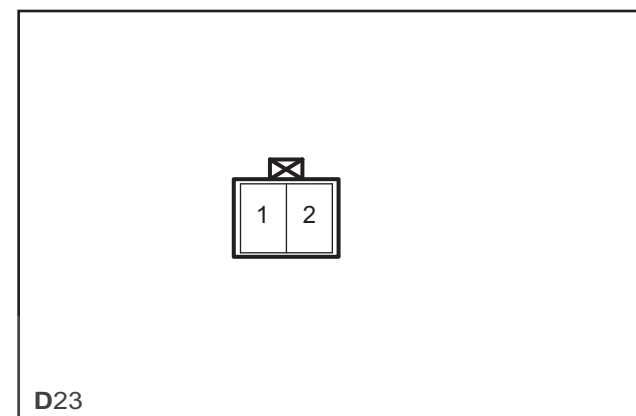

D23 Pin Definition

Pin Number	Wire Width / Color	Function
1	0.50 Gr/G	LR door lamp signal
2	0.50 Bl/W	Power 12V

LR Lock Motor Connector



D24 Pin Definition

Pin Number	Wire Width / Color	Function
1	0.50 Br/W	Power -
2	0.50 Br/G	Power +

Harness Connector View

RR Power Window

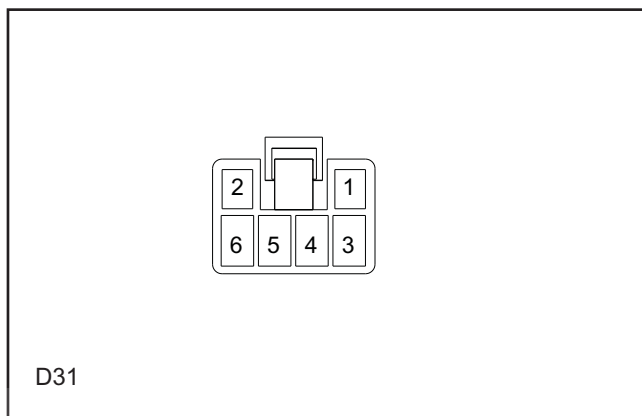

D31

D31 Pin Definition

Pin Number	Wire Width / Color	Function
1	--	
2	--	
3	--	
4	0.85 B/BI	RR window up signal
5	0.85 Y/R	RR window down signal
6	--	

RR Power Window Switch Connector

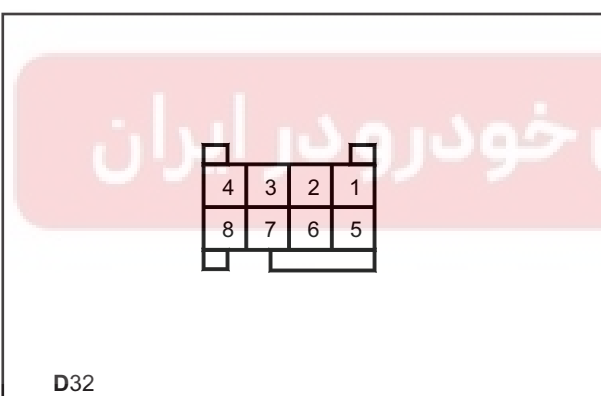

D32

D32 Pin Definition

Pin Number	Wire Width / Color	Function
1	0.50 Y/B	RR window up signal
2	--	
3	--	
4	--	
5	0.50 G	Safety lock signal
6	0.50 B	Ground
7	0.50 Y	RR window down signal
8	0.50 R	Power

RR Door Lamp Connector

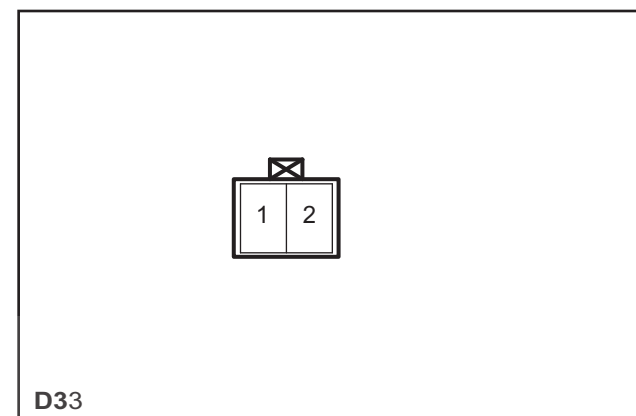

D33

D33 Pin Definition

Pin Number	Wire Width / Color	Function
1	0.50 Gr/Y	RR door lamp signal
2	0.50 R/BI	Power 12V

RR Lock Motor Connector



D34

D34 Pin Definition

Pin Number	Wire Width / Color	Function
1	0.50 Br/W	Power -
2	0.50 Br/G	Power +

Harness Connector View

Door Harness(LF) to I/P Harness Connector

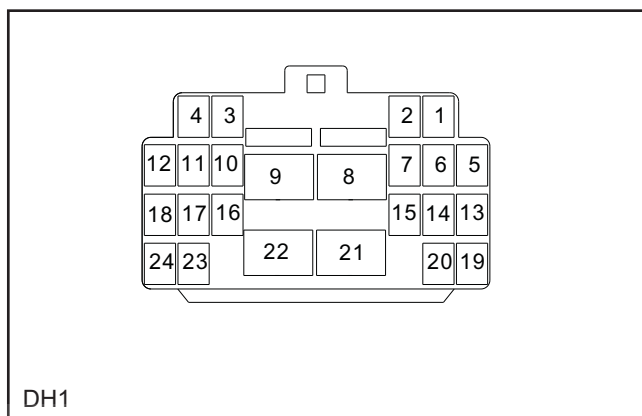

Door Harness(LR) to I/P Harness Connector

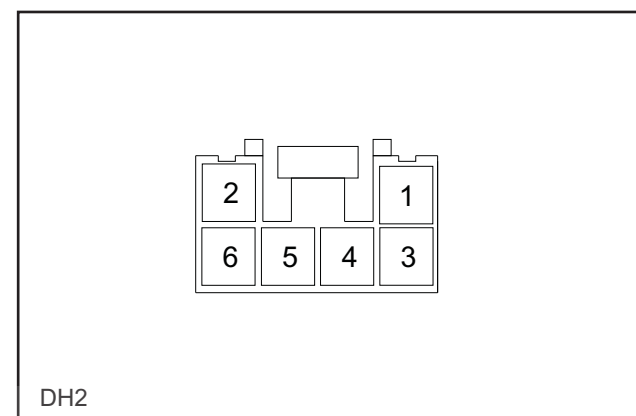

DH1 Pin Definition

Pin Number	Wire Width / Color	Function
1	0.50 W	LF speaker
2	0.50 W/B	LF speaker
3	0.30 BI/Y	RF window down signal
4	0.30 Y	RR window down signal
5	0.30 BI/G	RF window up signal
6	0.50 BI/R	Left rearview mirror X direction motor
7	0.50 G/R	Left rearview mirror Y direction motor
8	0.50 Y/G	Power ACC
9	0.50 Gr	LF window up signal
10	0.30 P	LR window down signal
11	0.30 P/B	LR window up signal
12	0.30 Y/B	RR window up signal
13	0.30 Br/B	LF window up signal
14	0.85 O	LF window down signal
15	0.30 Br	LF window down signal
16	0.50 W/BI	LF lock motor power-
17	0.30 G	Safety lock(Children lock) switch
18	0.50 Y/R	LF lock motor power+
19	0.30 B/Y	Central lock motor power+
20	0.50 W/Y	Central lock motor power-
21	0.85 Br/V	Power
22	--	
23	0.85 B	Ground
24	0.50 B/G	LF lock status switch signal

DH2 Pin Definition

Pin Number	Wire Width / Color	Function
1	0.50 R/BI	Power 12V
2	0.50 Br/R	Public wire
3	0.50 R/Y	Left turn lamp
4	0.50 R	Illumination power
5	--	
6	0.50 Gr	LF door lamp signal

Harness Connector View

Door Harness(RF) to I/P Harness Connector

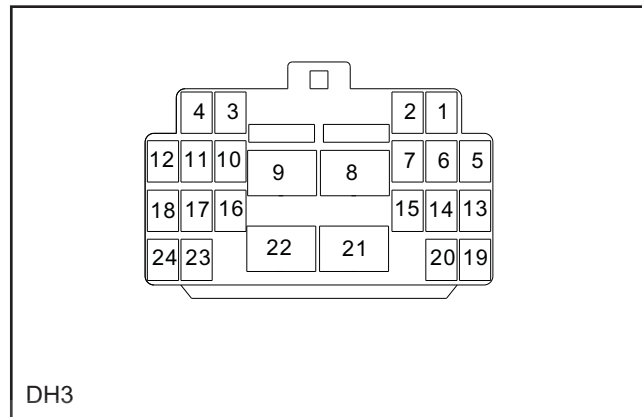

DH3

DH3 Pin Definition

Pin Number	Wire Width / Color	Function
1	0.50 W/Bl	Right rearview mirror X direction motor
2	0.50 G/Y	Right rearview mirror Y direction motor
3	0.30 Br/R	Public wire
4	0.30 Gr/B	RF speaker
5	0.85 B	Ground
6	0.50 R/Bl	Power
7	--	
8	--	
9	--	
10	--	
11	0.30 Br/Y	Right turn lamp
12	0.85 B/G	RF window down signal
13	0.30 G	Safety lock(Children lock) switch
14	0.50 Bl/Y	RR door lamp signal
15	0.50 Gr	RF speakerl
16	--	
17	0.50 Gr/Bl	RF door lamp signal
18	0.85 B/Y	RF window up signal
19	0.30 R	Illumination power
20	0.30 Bl/G	RF window up signal
21	0.85 Br/V	Power
22	--	
23	0.50 Br/G	Others lock
24	0.50 Br/W	Others lock



Harness Connector View

Roof Harness Connector(R--)

Rear Dome Lamp Connector

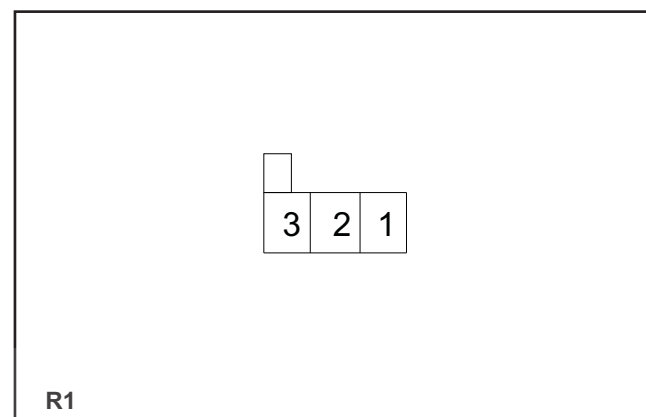

R1 Pin Definition

Pin Number	Wire Width / Color	Function
1	0.50 B/R	Power+
2	0.50 W/R	Door control signal
3	0.50 B	Ground

Sunroof Connector

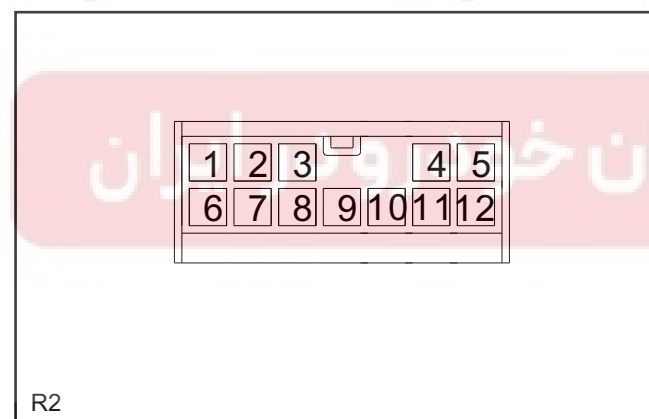

R2 Pin Definition

Pin Number	Wire Width / Color	Function
1	1.25 Gr	Power
2	--	
3	--	
4	--	
5	--	
6	1.25 B	Ground

Pin Number	Wire Width / Color	Function
7	0.50 G	Sunroof open
8	0.50 G/B	Sunroof close
9	0.50 G/W	Auto close signal
10	0.50 Y/G	ACC signal
11	--	
12	0.50 B/W	Ground

Front Dome Lamp Connector

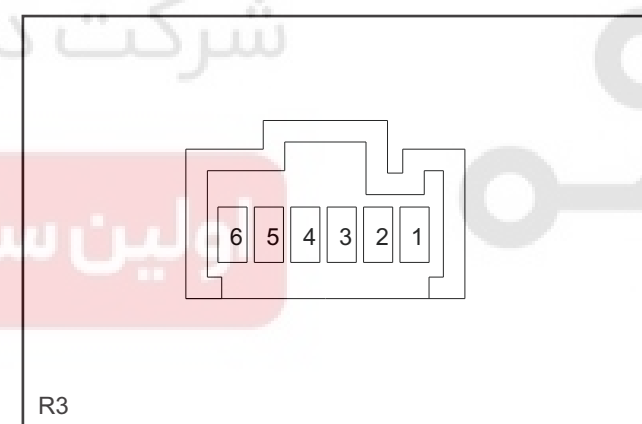

R3 Pin Definition

Pin Number	Wire Width / Color	Function
1	0.50 B	Ground
2	0.50 W/R	Door control signal
3	0.50 B/R	Power 12V
4	0.50 G/B	Sunroof close
5	0.50 G	Sunroof open
6	0.50 B/W	Ground

Harness Connector View

Roof harness to I/P harness connector

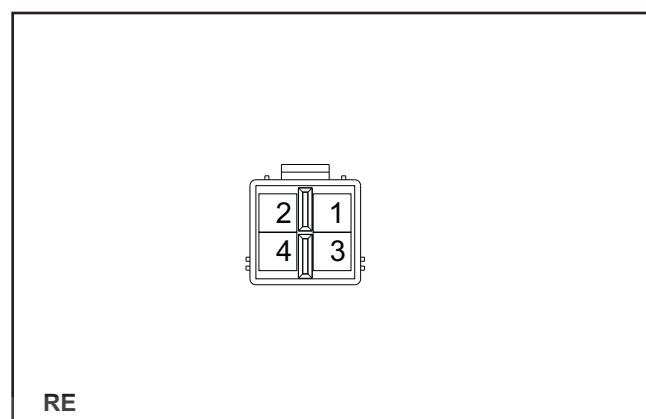

RE Pin Definition

Pin Number	Wire Width / Color	Function
1	0.85 W/R	Door control signal
2	0.50 B	Ground
3	--	
4	0.50 B/R	Power+

Roof harness to I/P harness connector



RE2 Pin Definition

Pin Number	Wire Width / Color	Function
1	0.50 Y/G	ACC signal
2	0.50 G/W	Auto close signal
3	--	
4	0.85 Gr	Power B+

SRS Harness Connector(S--)

Passenger Airbag Connector

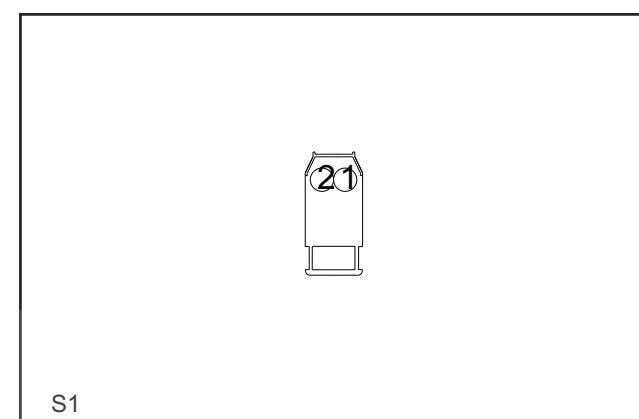

S1 Pin Definition

Pin Number	Wire Width / Color	Function
1	0.30 G/R	Passenger airbag positive pole
2	0.30 R/W	Passenger airbag negative pole

Passenger Airbag Connector



S2 Pin Definition

Pin Number	Wire Width / Color	Function
1	0.30 G/W	Driver airbag positive pole
2	0.30 G	Driver airbag negative pole

Harness Connector View

Timing Coil Connector

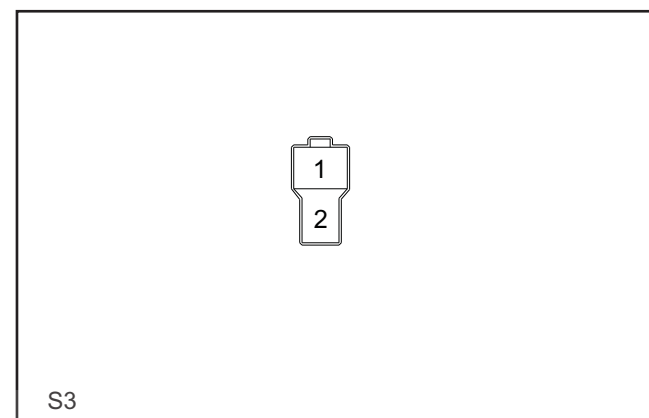

S3 Pin Definition

Pin Number	Wire Width / Color	Function
1	0.30 Y/W	Driver seat belt ground
2	0.30 Y/R	Driver safety belt switch

SRS ECU Connector

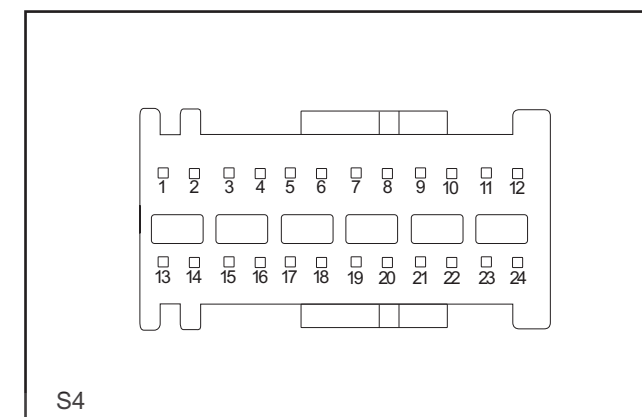

S4 Pin Definition

Pin Number	Wire Width / Color	Function
1	0.30 Br	K-line
2	- -	
3	- -	
4	- -	
5	0.30 Y/G	Collision signal output
6	- -	
7	0.50 Y/W	Driver safety belt ground
8	0.50 Y/R	Driver safety belt switch signal
9	- -	
10	- -	
11	- -	
12	0.85 R/Y	
13	- -	
14	0.30 Y/G	Driver safety belt unlock alarm
15	0.30 G/W	Driver airbag negative pole
16	0.30 G	Driver airbag positive pole
17	0.50 R/W	Passenger airbag positive pole
18	0.50 G/R	Passenger airbag negative pole
19	- -	
20	- -	
21	- -	
22	- -	
23	0.85 B	Ground
24	0.50 Y/W	SRS indicator

Harness Connector View

SRS Harness to I/P harness connector

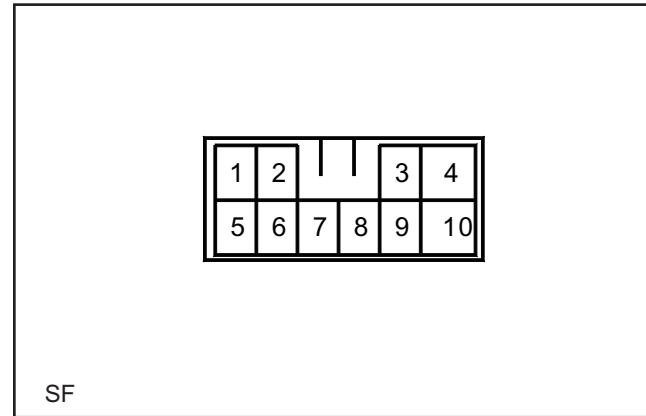

SF Pin Definition

Pin Number	Wire Width / Color	Function
1	0.30 Y/BI	Driver safety belt unlock alarm signal
2	0.30 Y/G	Collision signal output
3	--	
4	--	
5	--	
6	0.30 Br	K-line
7	0.50 Y/W	SRS indicator
8	0.85 R/Y	Power+
9	--	
10	--	

Reserving Radar Harness Connector(L--)

Reserving Radar Detector Connector

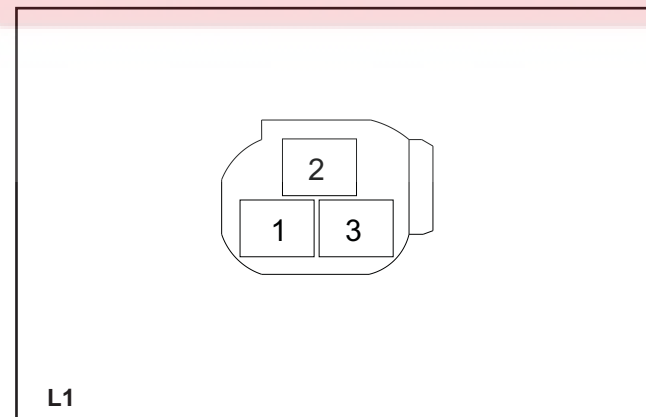

L1 Pin Definition

Pin Number	Wire Width / Color	Function
1	0.50 G	Signal+
2	0.50 Y	Radar detector signal1
3	0.50 B	Signal-

Reserving Radar Detector Connector

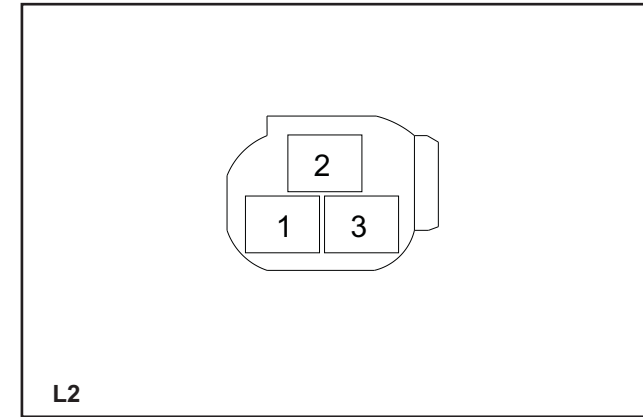

L2 Pin Definition

Pin Number	Wire Width / Color	Function
1	0.50 G	Signal+
2	0.50 Y/R	Radar detector signal 2
3	0.85 B	Signal-

Reversing Radar harness to Body harness Connector



LH1 Pin Definition

Pin Number	Wire Width / Color	Function
1	0.50 G	Power
2	0.50 B	Ground
3	--	
4	0.50 Y/R	Radar detector signal 1
5	0.50 Y	Radar detector signal 2
6	--	

Harness Connector View

HAVC Harness Connector(A--)

HAVC actuator connector

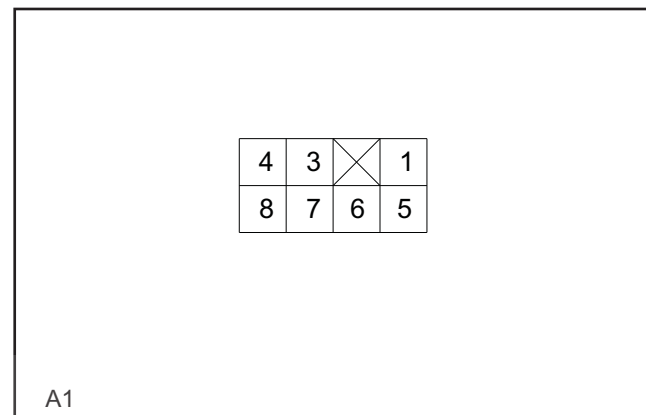

A1

A1 Pin Definition

Pin Number	Wire Width / Color	Function
1	0.50 B/W	Ground
2	--	
3	0.50 W/B	Mixture actuator eaction signal
4	0.50 Y/R	Sensor reference vottage
5	0.85 B	Mode valve actuator power
6	0.50 G/W	Blower speed reaction signal
7	0.50 G/R	Recircuilation valve actuator power
8	0.85 Br/G	Controller power

Blower connector

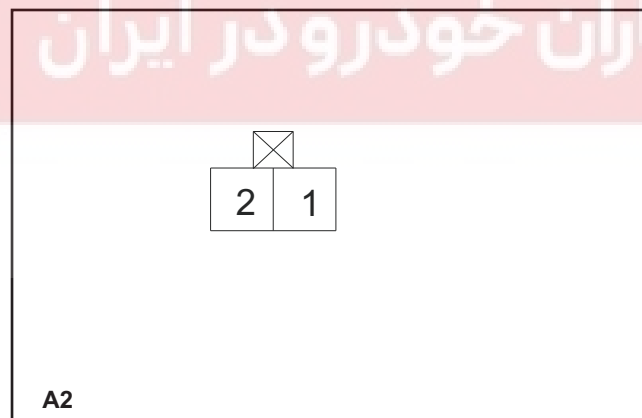

A2

A2 Pin Definition

Pin Number	Wire Width / Color	Function
1	3.00 Y	Blower motor power+
2	3.00 R/W	Signal-

Blower speed adjust module connector

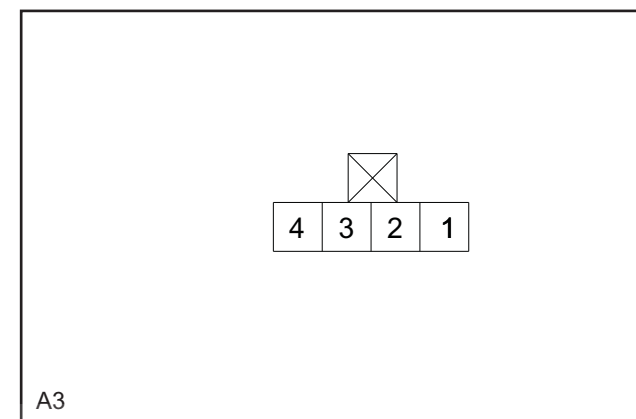

A3

A3 Pin Definition

Pin Number	Wire Width / Color	Function
1	3.00 R/W	Signal
2	0.50 Br/R	Mode valve actuator power
3	0.50 Br/W	Background light adjustment signal
4	3.00 B	Ground

Evaporator temperature sensor connector



A4

A4 Pin Definition

Pin Number	Wire Width / Color	Function
1	0.50 B/W	Sensor reference ground
2	0.50 W/R	Evaporator temperature sensor signal

Harness Connector View

Recirculation valve actuator connector

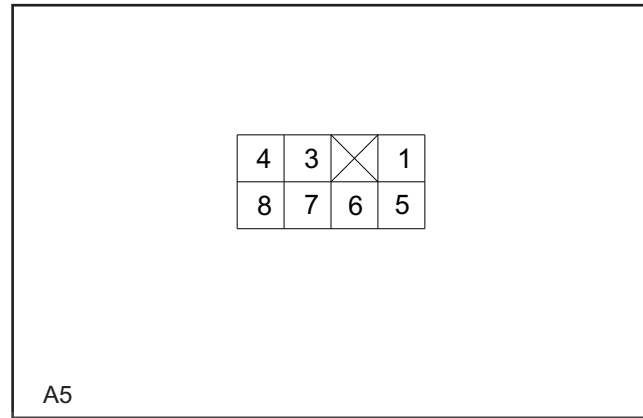

A5 Pin Definition

Pin Number	Wire Width / Color	Function
1	--	
2	--	
3	--	
4	--	
5	0.85 B	Mode valve actuator power
6	0.50 G/B	
7	0.50 G/Y	
8	0.85 Br/G	Controller power

Blower module actuator connector



A6 Pin Definition

Pin Number	Wire Width / Color	Function
1	0.50 BI/R	Controller power
2	--	
3	0.50 BI/Y	Illumination switch signal
4	0.50 BI/W	Recirculation valve actuator power

Pin Number	Wire Width / Color	Function
5	0.85 B	Mode valve actuator power
6	0.50 BI/B	Recirculation valve actuator power
7	0.50 BI/O	Blower speed adjust module signal
8	0.85 Br/G	Controller power

HAVC Connector

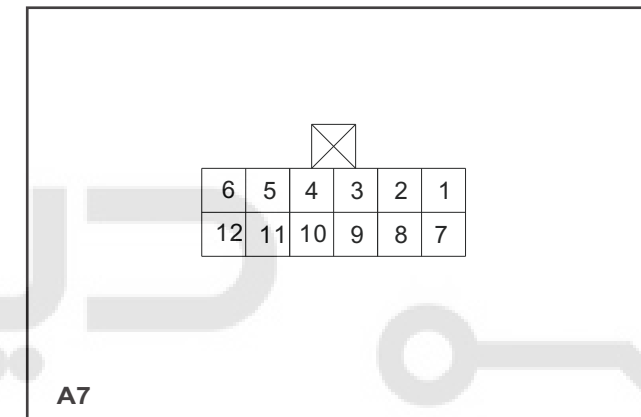

A7 Pin Definition

Pin Number	Wire Width / Color	Function
1	--	
2	0.50 Gr/R	Unlock signal
3	0.50 B/R	Hazard alarm signal
4	0.50 BI/W	Pre-unlock switch signal
5	0.50 R/Y	Hazard warning flash signal
6	0.50 Y/R	Sensor reference voltage
7	0.50 W/R	Evaporator valve temperature signal
8	0.50 W/B	Mode valve actuator status reaction signal
9	0.50 G/BI	Lock switch signal
10	0.50 B/W	Sensor reference ground
11	0.50 BI/W	Mode valve actuator power
12	0.50 R/G	A/C compressor power

Abbreviations

Abbreviations

Abbreviation	Description
A/C	Air Conditioning
AAT	Ambient Air Temperature
ABS	Anti-lock Brake System
AM/FM	Amplitude Modulation/ Frequency Modulation
APP	Accelerator Pedal Position
ASR	Acceleration Slip Regulation
AT	Automatic Transmission
ATF	Automatic Transmission Fluid
BCM	Body Control Module
CAN	Controller Area Network
CD	Compact Disc
CKP	Crankshaft Position Sensor
CMP	Camshaft Position Sensor
CRK	Crank
DDM	Driver Door Module
DLC	Data Link Connector
DOHC	Double Overhead Camshaft
DTC	Diagnostic Trouble Code
DVD	Digital Video Disk
EBD	Electronic Brakeforce Distribution
ECM	Engine Control Module
ECT	Engine Coolant Temperature
EGR	Exhaust-Gas Recirculation
EOBD	European On Board Diagnostic
ESP	Electronic Stability Program
ETC	Electronic Tune Control
EVAP	Evaporative Emission Control System
FWD	Front Wheel Drive
GPS	Global Positioning System
GVM	Gross Vehicle Mass
HCU	Hydraulic Control Unit
HFM	Hands Free Module
HID	High Intensity Discharge
HO2S	Heated Oxygen Sensor
HVAC	Heating, Ventilation and Air Conditioning
I/P	Instrument Panel
IAC	Idle Air Control Valve

Abbreviation	Description
IAT	Intake Air Temperature
ICU	Integrated Control Unit
IPC	Instrument Panel Cluster
ISO	International Standards Organization
ISS	Input Shaft Speed
KS	Knock Sensor
LED	Light Emitting Diode
LF	Left Front
LIN	Local Interconnect Network
LR	Left Rear
MAF	Mass Air Flow
MAP	Manifold Absolute Pressure
MIL	Malfunction Indicator Lamp
MP3	MPEG Audio Layer 3
MT	Manual Transmission
MTC	Manual Temperature Control
MY	Model Year
OBD-II	On Board Diagnostic II
OEM	Original Equipment Manufacturer
PAM	Parking Aid Module
PCV	Positive Crankcase Ventilation
PDC	Power Distribution Center
PDM	Passenger Door Module
PIN	Personal Identification Number
PWM	Pulse Width Modulation
RF	Right Front
RR	Right Rear
SAE	Society of Automotive Engineers
SAS	Steering Angle Sensor
SCCM	Steering Column Control Module
SDM	Supplemental Diagnostic Module
SFI	Sequential Fuel Injection
SOHC	Single Overhead Camshaft
SRI	Service Reminder Indicator
SRS	Supplemental Restraint System
TCC	Torque Converter Clutch
TCM	Transmission Control Module
TIR	Total Indicator Reading

Abbreviations

Abbreviation	Description
TPMS	Tire Pressure Monitoring System
TPS	Throttle Position Switch
TRS	Transmission Range Sensor
TSB	Technical Service Bulletin
TWC	Three-way Catalyst
VFD	Vacuum Fluorescent Display
VIN	Vehicle Identification Number
VSS	Vehicle Speed Sensor
WSS	Wheel Speed Sensor

⚠ Note: Refer to the workshop manual for the abbreviations not covered by the list.



دیجیتال خودرو

شرکت دیجیتال خودرو سامانه (مسئولیت محدود)

اولین سامانه دیجیتال تعمیرکاران خودرو در ایران