

DCN Node - Dena SMS MUX

6000A

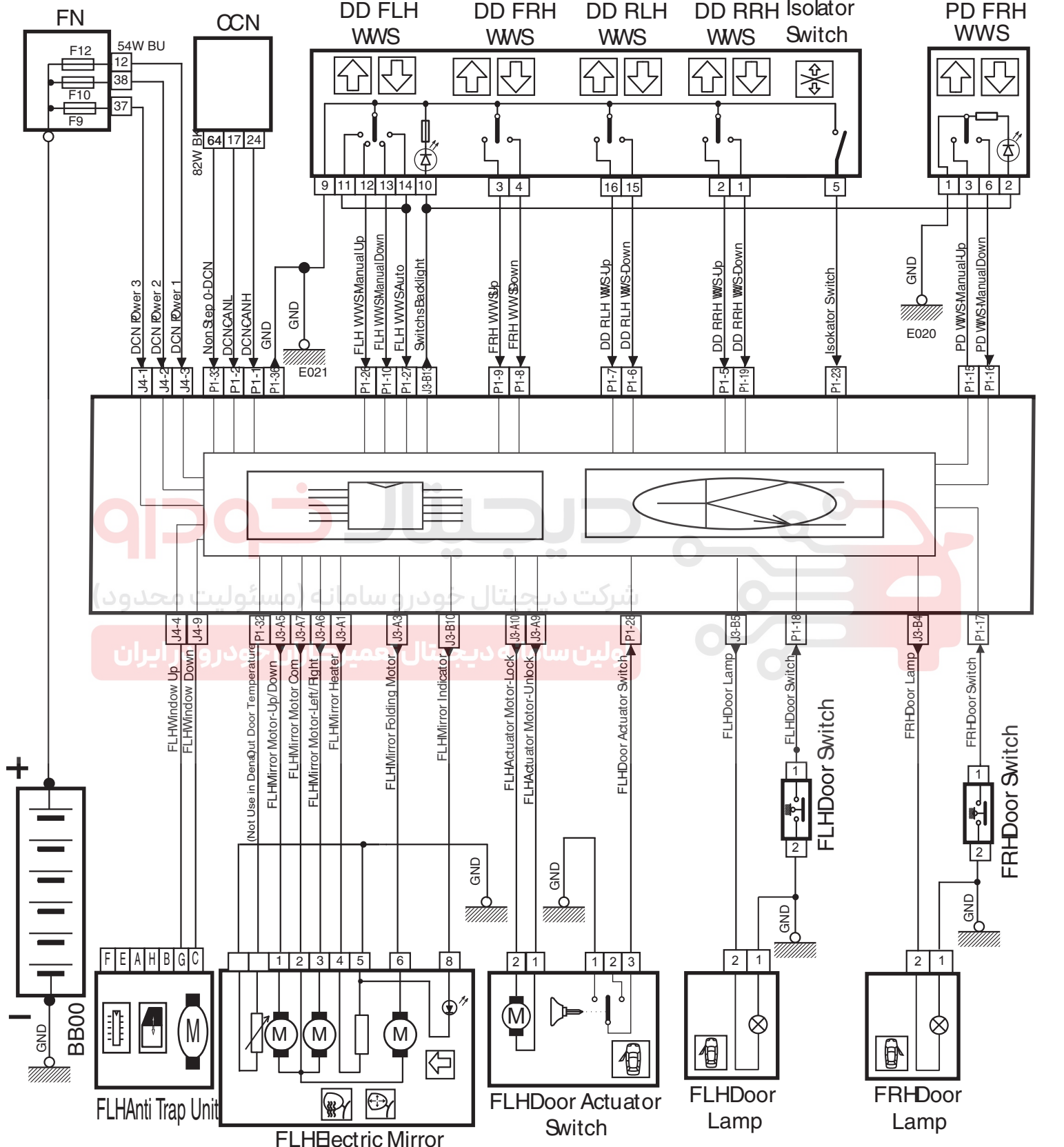

- J3-A = 10W WI
- J3-B = 14W WI
- J4 = 9W WI
- P1 = 40W WI

6000B Mirror Switch

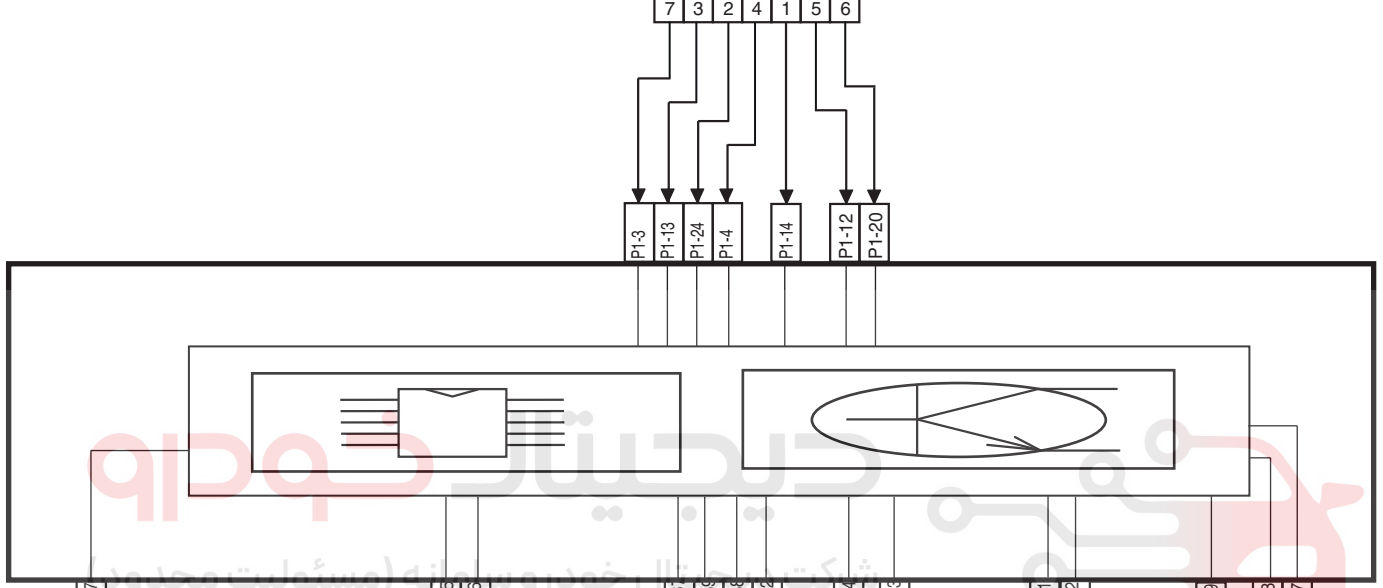
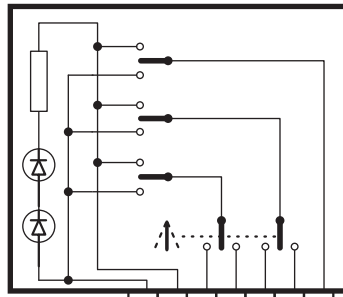

P1-37
Crash Unlock

J4-5
FRHWindow Up
J4-6
FRHWindow Down

J3-B
FRHMirror Motor-Up/Down
J3-B
FRHMirror Motor Com
J3-B
FRHMirror Motor-Left/Right
J3-A
FRHMirror Heater
J3-A
FRHMirror Folding Motor
J3-B
FRHMirror Indicator

J3-B1
FRH Actuator Motor Lock
J3-B2
FRH Actuator Motor-UnLock

P1-29
FRHDoor Actuator Switch

J4-8
J4-7
GND

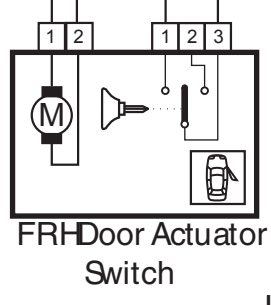
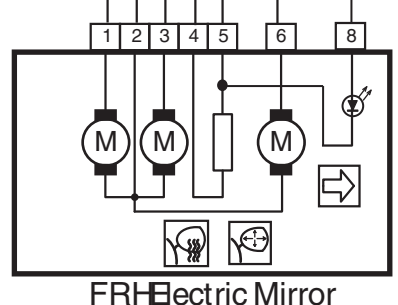
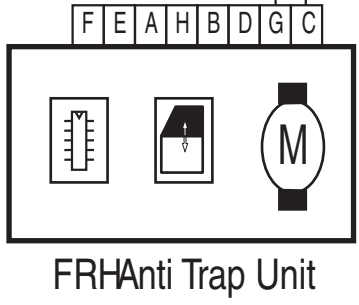
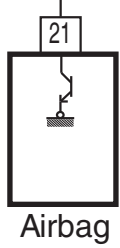

- J3-A = 10W WI
- J3-B = 14W WI
- J4 = 9W WI
- P1 = 40W WI