

8.2 Diagnosis and Inspection

8.2.1 System Circuit Diagram

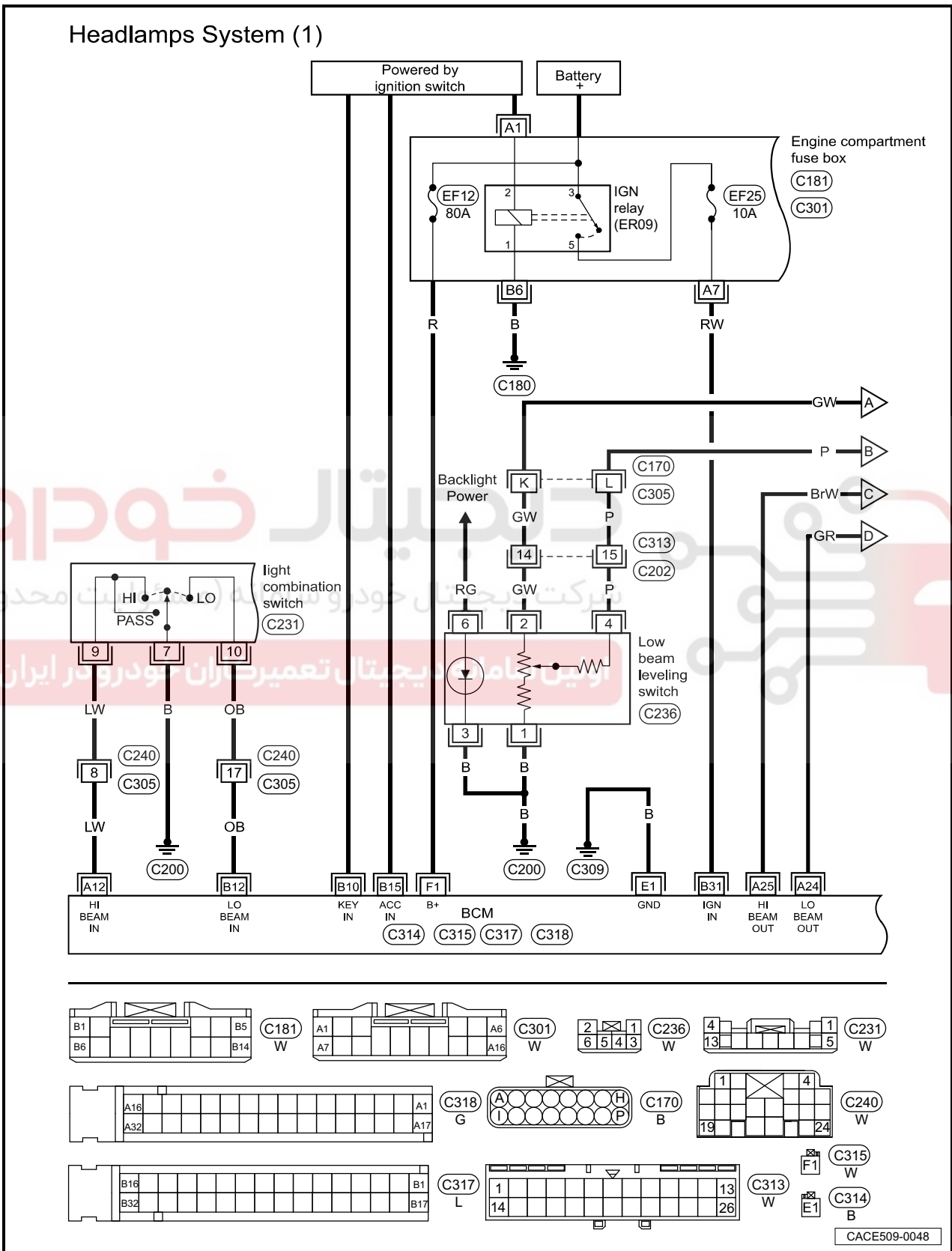

07 - Electrical Equipment

Headlamps System (2)

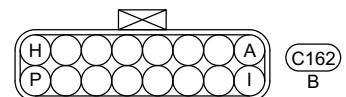
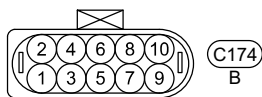
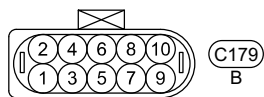
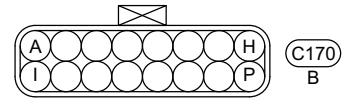
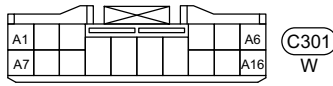
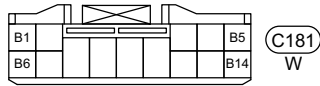
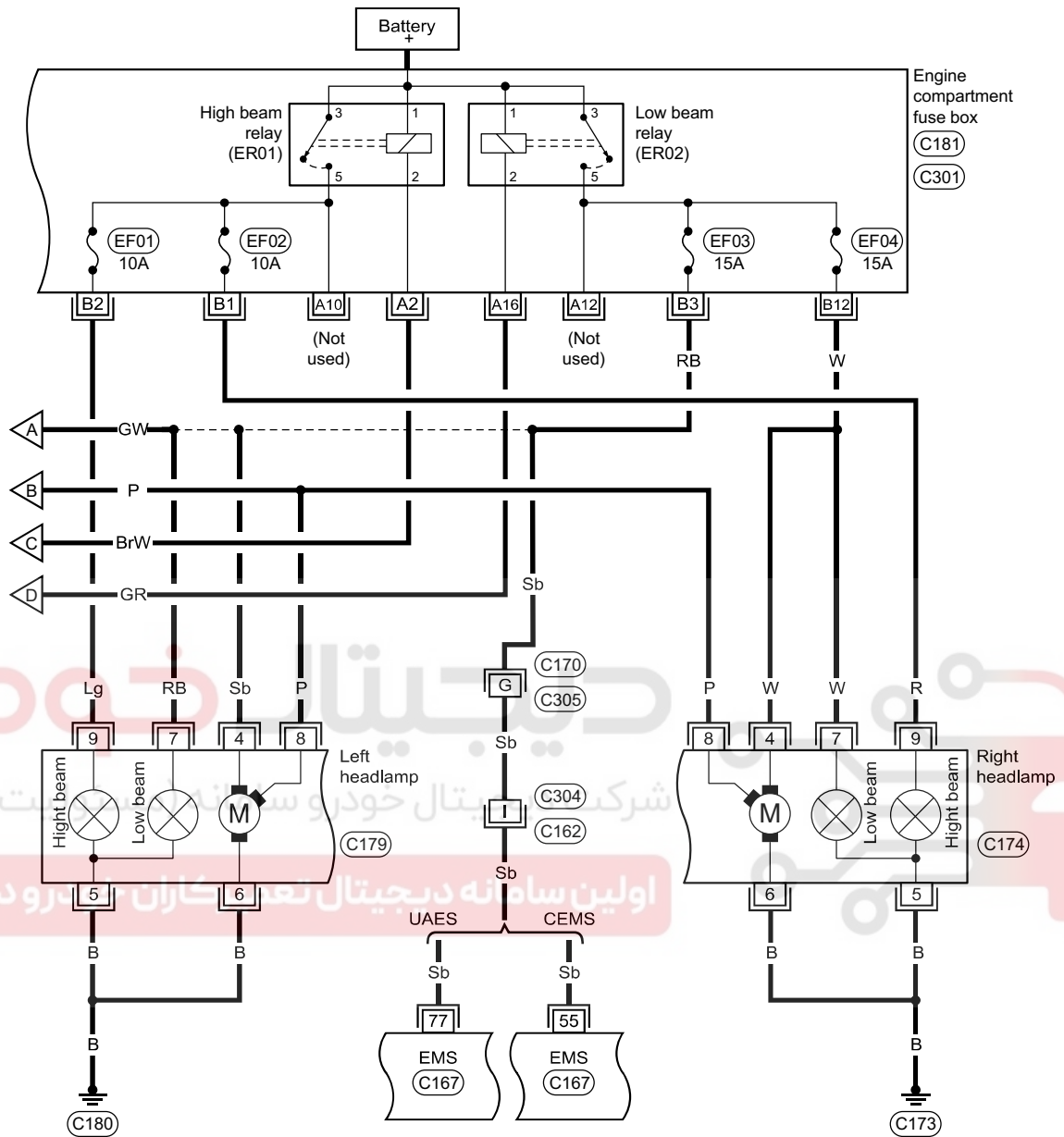

CACE509-0049