

5.2.2 System Circuit Diagram

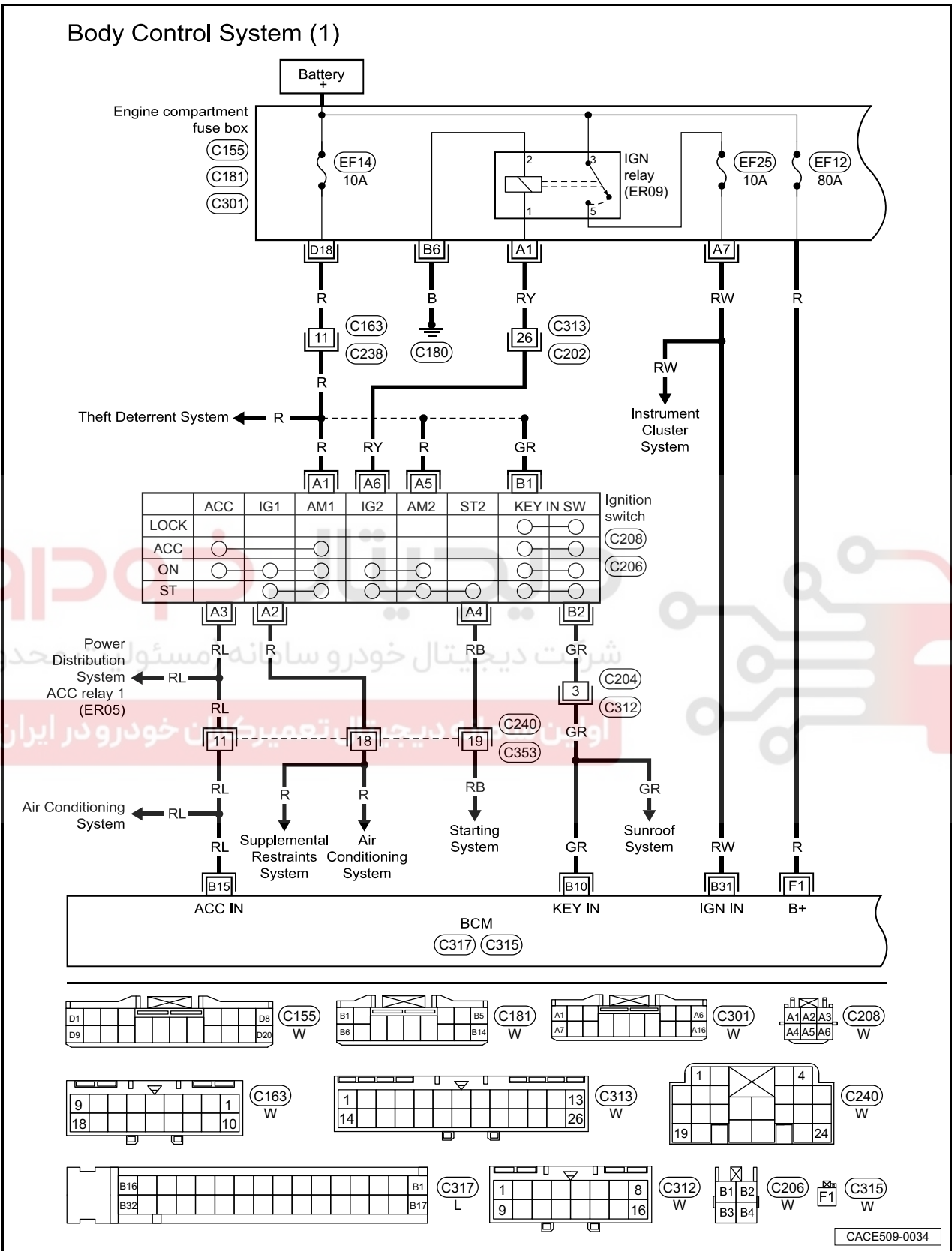

07

07 - Electrical Equipment

Body Control System (2)

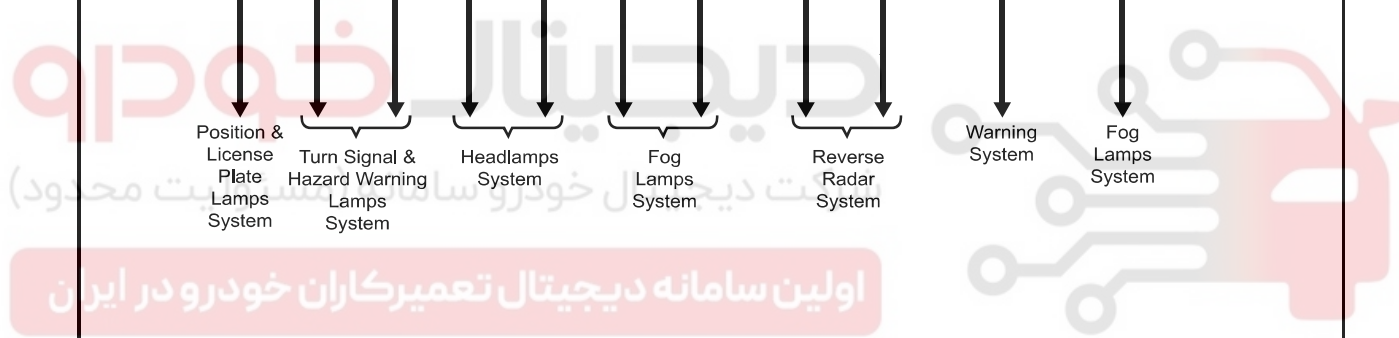
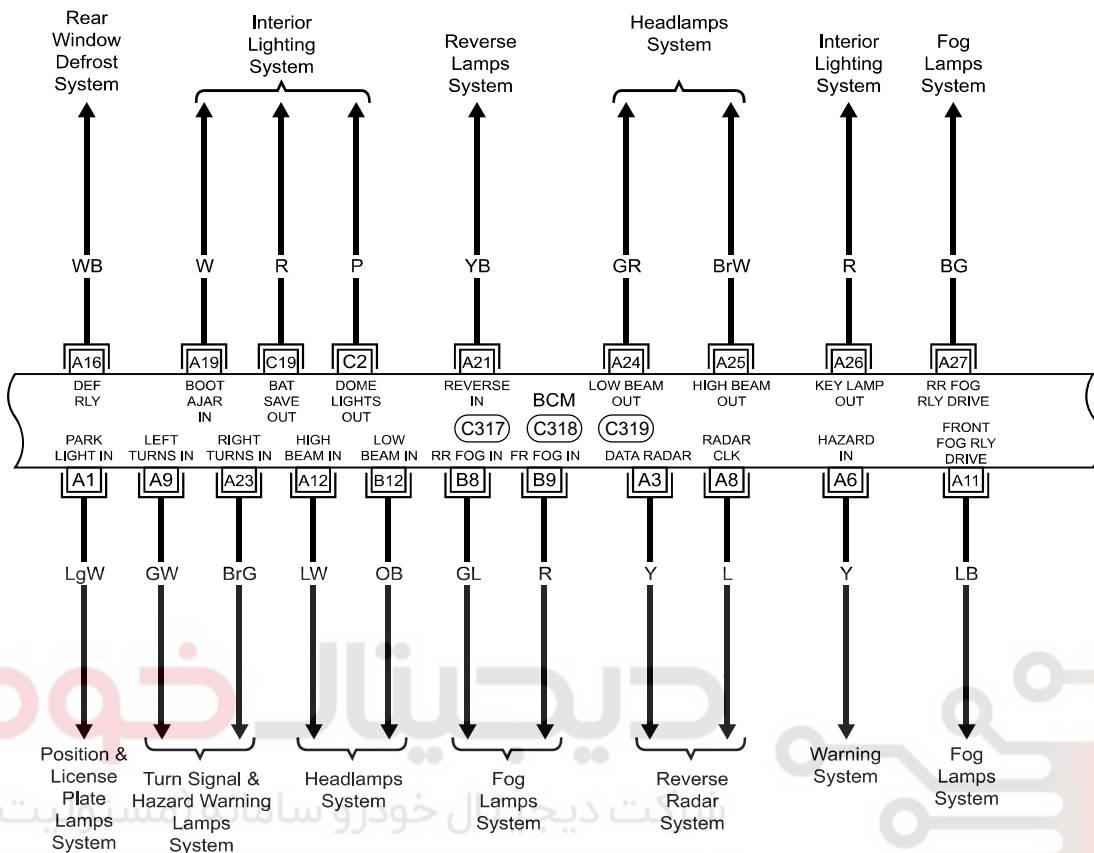

07

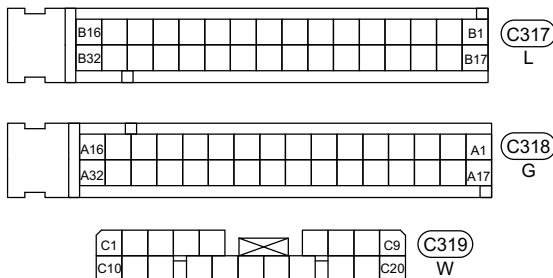

CACE509-0035

### Body Control System (3)

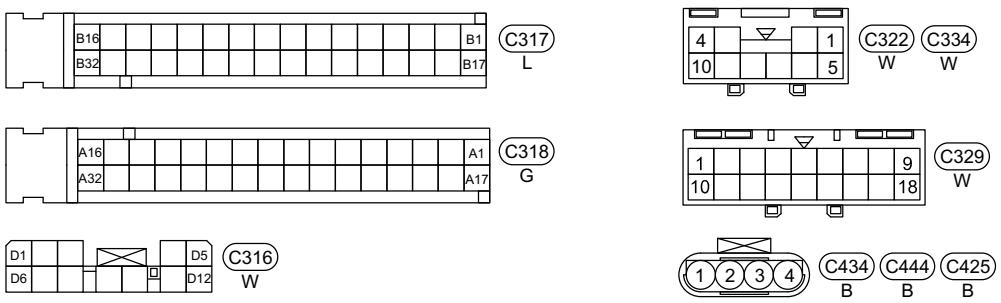
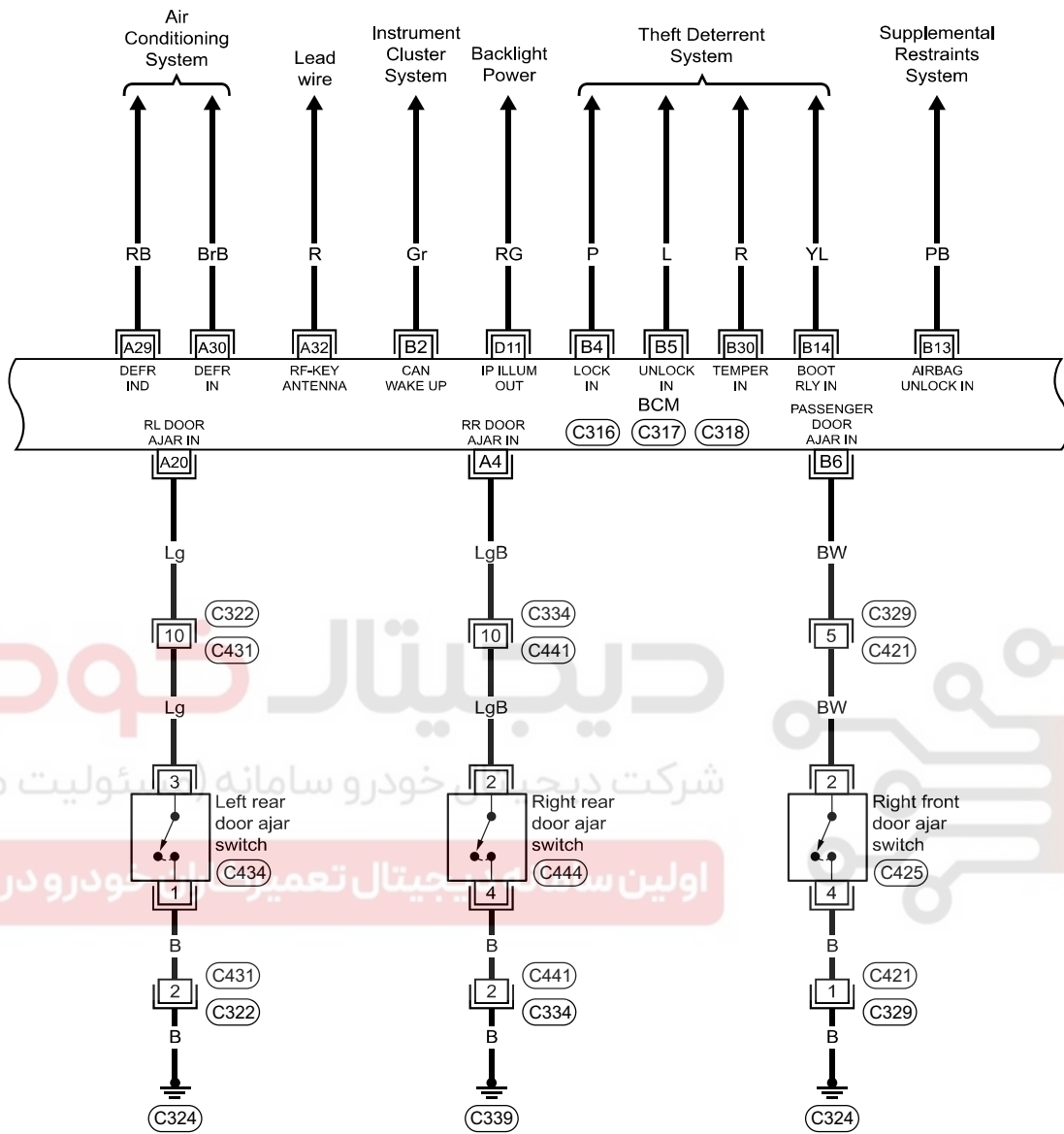

CACE509-0036

07 - Electrical Equipment

Body Control System (4)

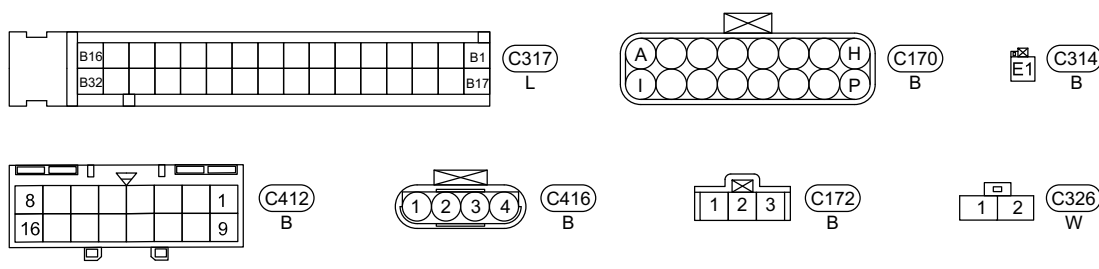
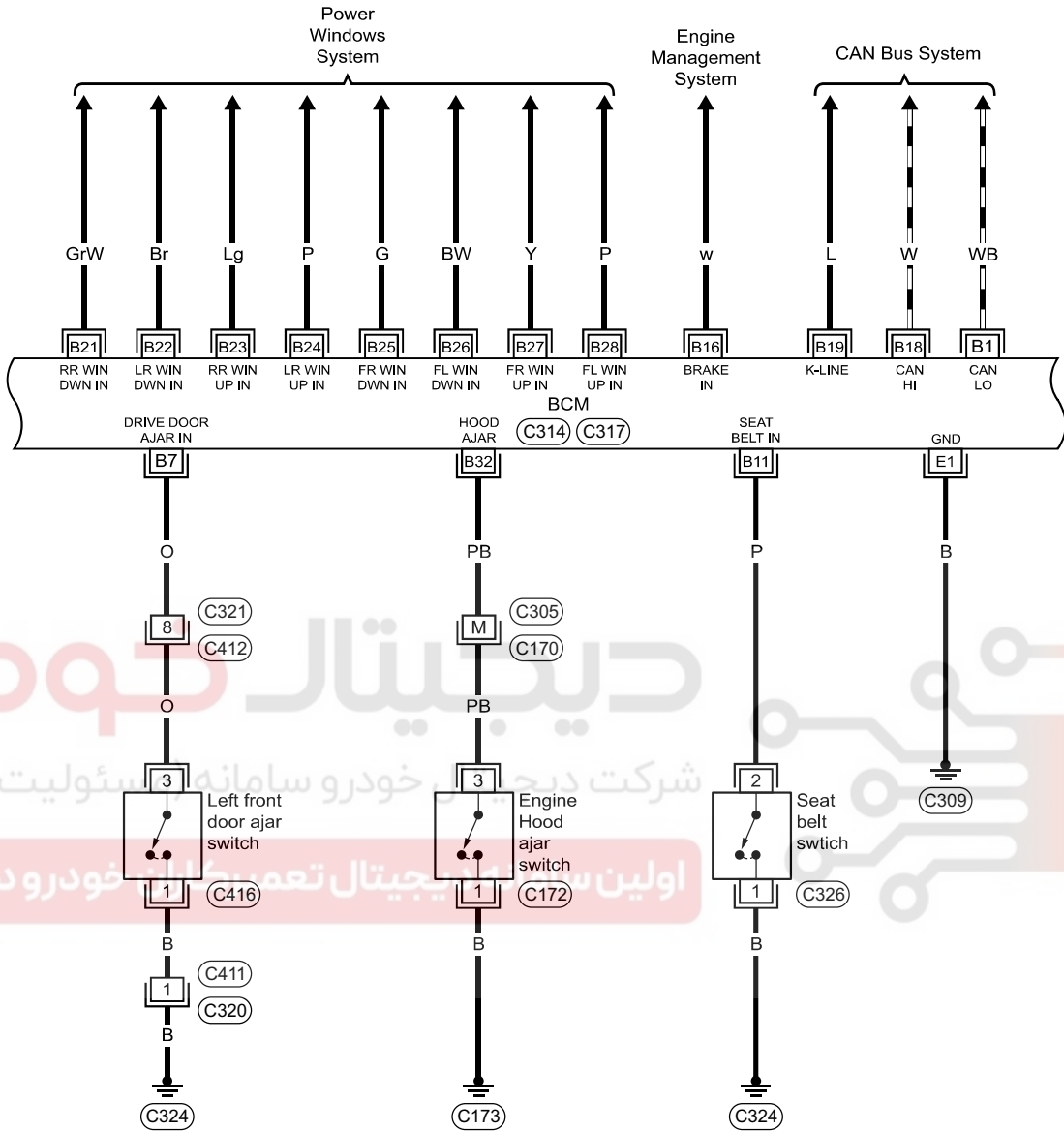

CACE509-0037

07

### Body Control System (5)

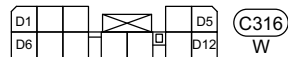
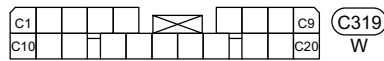
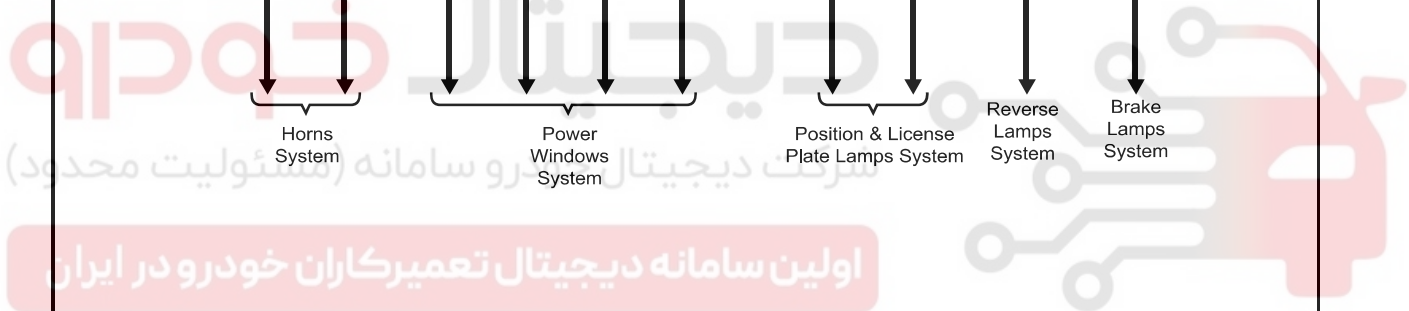
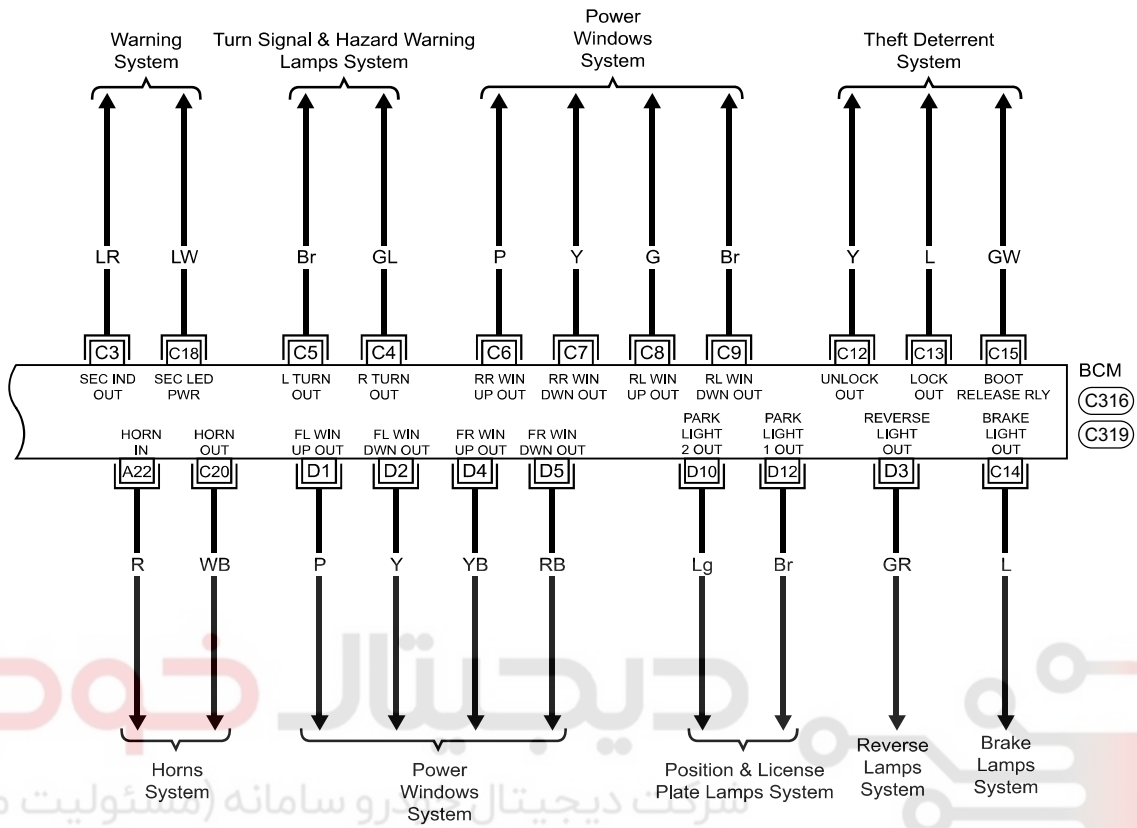

CACE509-0038