

Start System 1 (PEPS)



Harness Connector	Name	Page
M03	BCM C4	21
G51	Main Relay Left GND A	43

دیجیتال خودرو

شرکت دیجیتال خودرو سامانه (مسئولیت محدود)

اولین سامانه دیجیتال تعمیرکاران خودرو در ایران



M03 C4_BCM

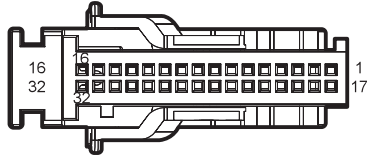

G51 Main Relay Left GND A

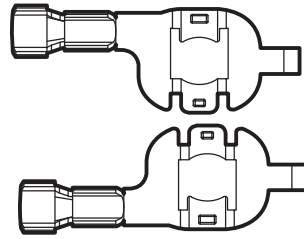

دیجیتال خودرو

شرکت دیجیتال خودرو سامانه (مسئولیت محدود)

اولین سامانه دیجیتال تعمیرکاران خودرو در ایران



Starting system 2 (1.5TGDI+DCT)

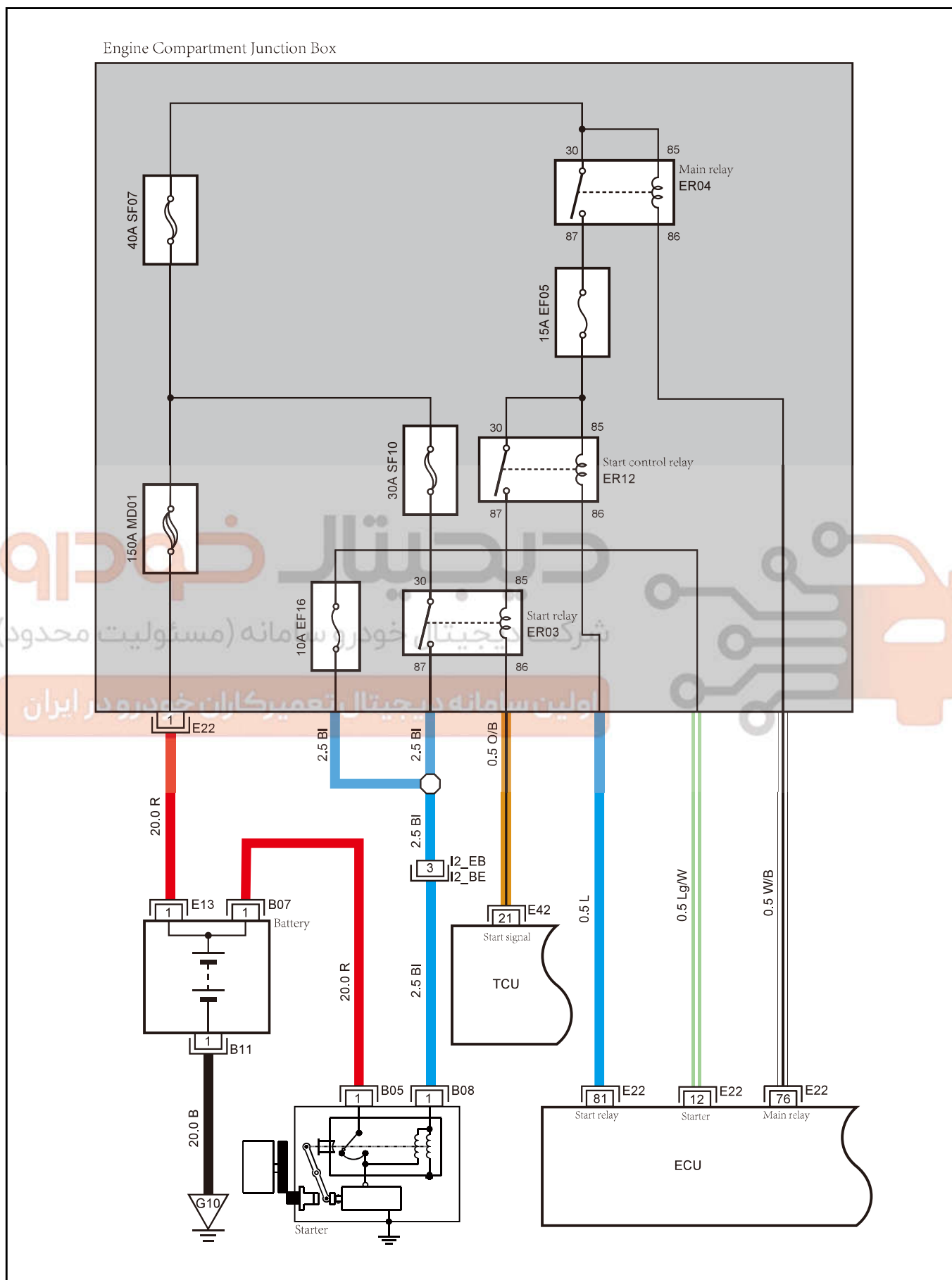

C22 ECU_1.5T GDI_C

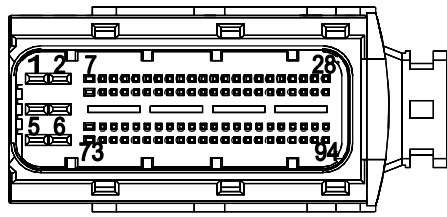

B05 1.5T GDI
Generator excitation

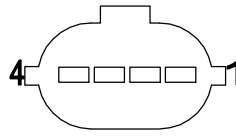

B08 1.5T GDI Generator B+

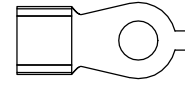

B01 Battery negative connector

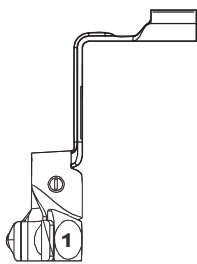

E13 Battery positive connector

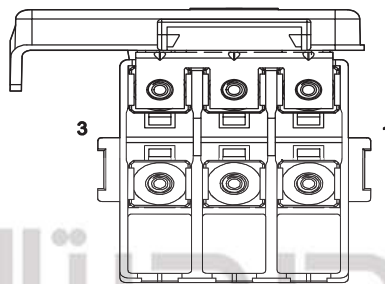

E22 EJB the positive connection
to connect power head

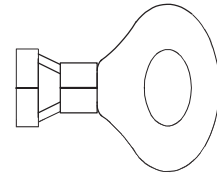

دیجیتال خودرو
شرکت دیجیتال خودرو سامانه (مسئولیت محدود)
اولین سامانه دیجیتال تعمیرکاران خودرو در ایران

B07 Battery power harness
connector for starter

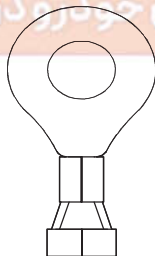

I2_BE Power harness connection
engine harness

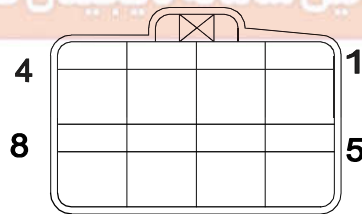

I2_EB Engine harness connection
power harness

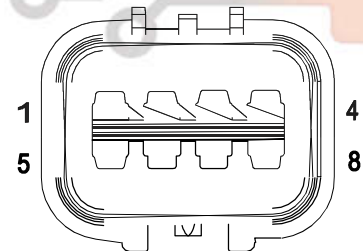

E42 DCT TCU

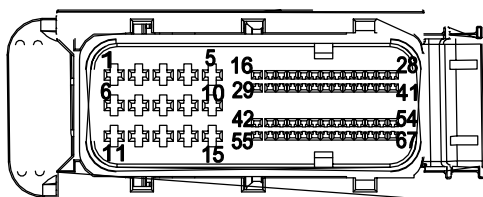

G21 Put iron battery cathode

