

DATA LINK DETAILS

E43FA177

Data Link Details (1)

SD200-1

C-CAN

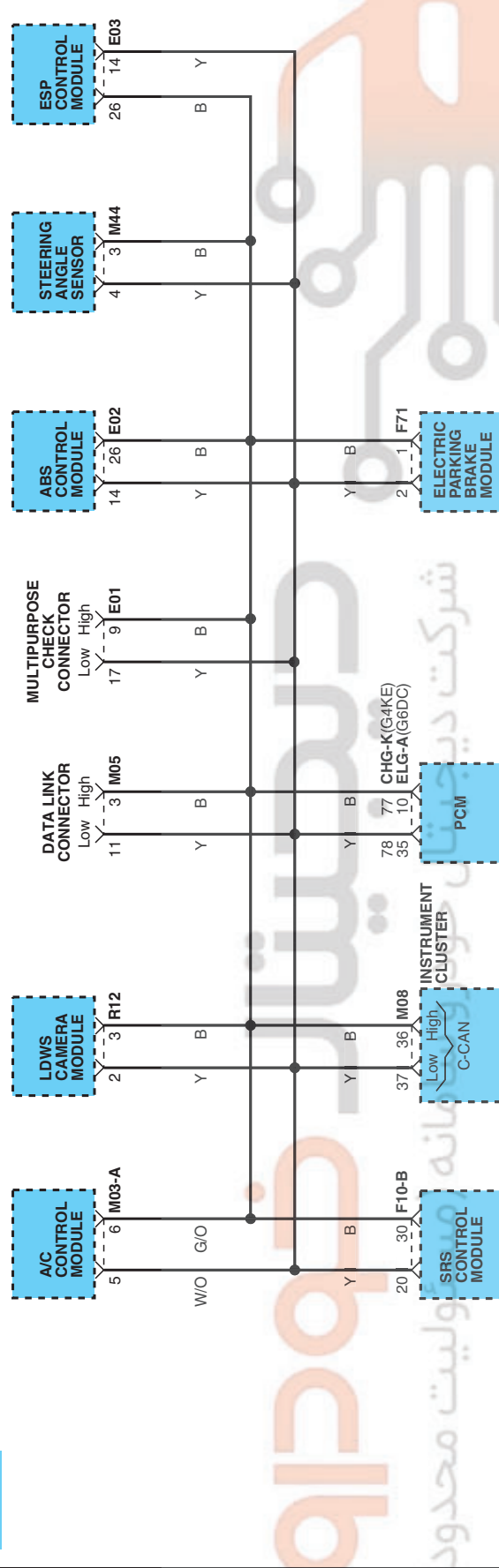

MM-CAN

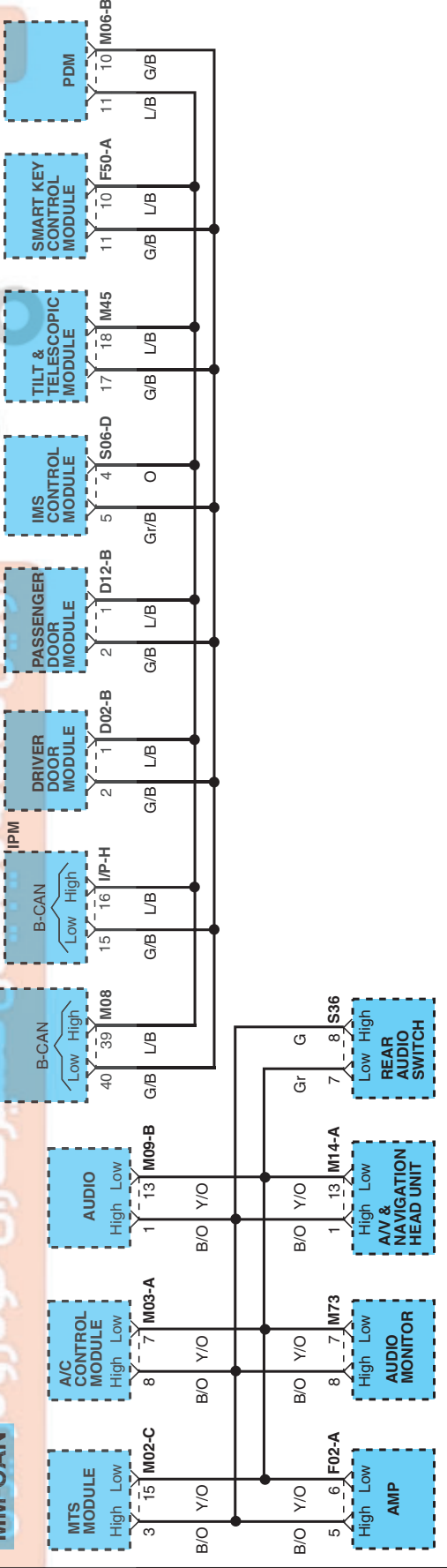

B-CAN

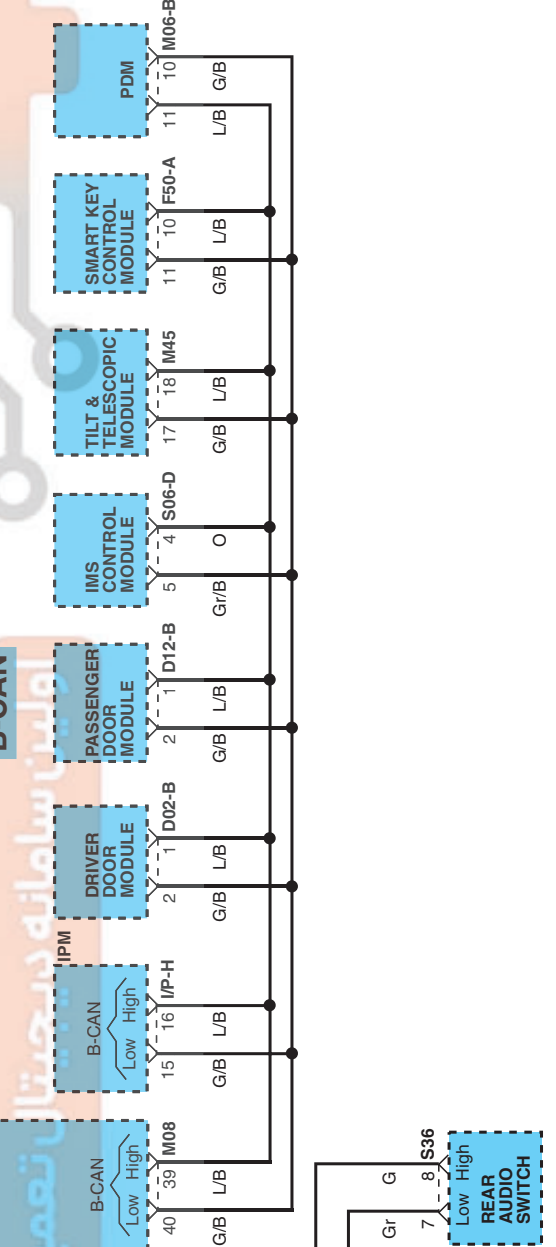

EVGSD12200AL

DATA LINK DETAILS

Data Link Details (2)

SD200-2

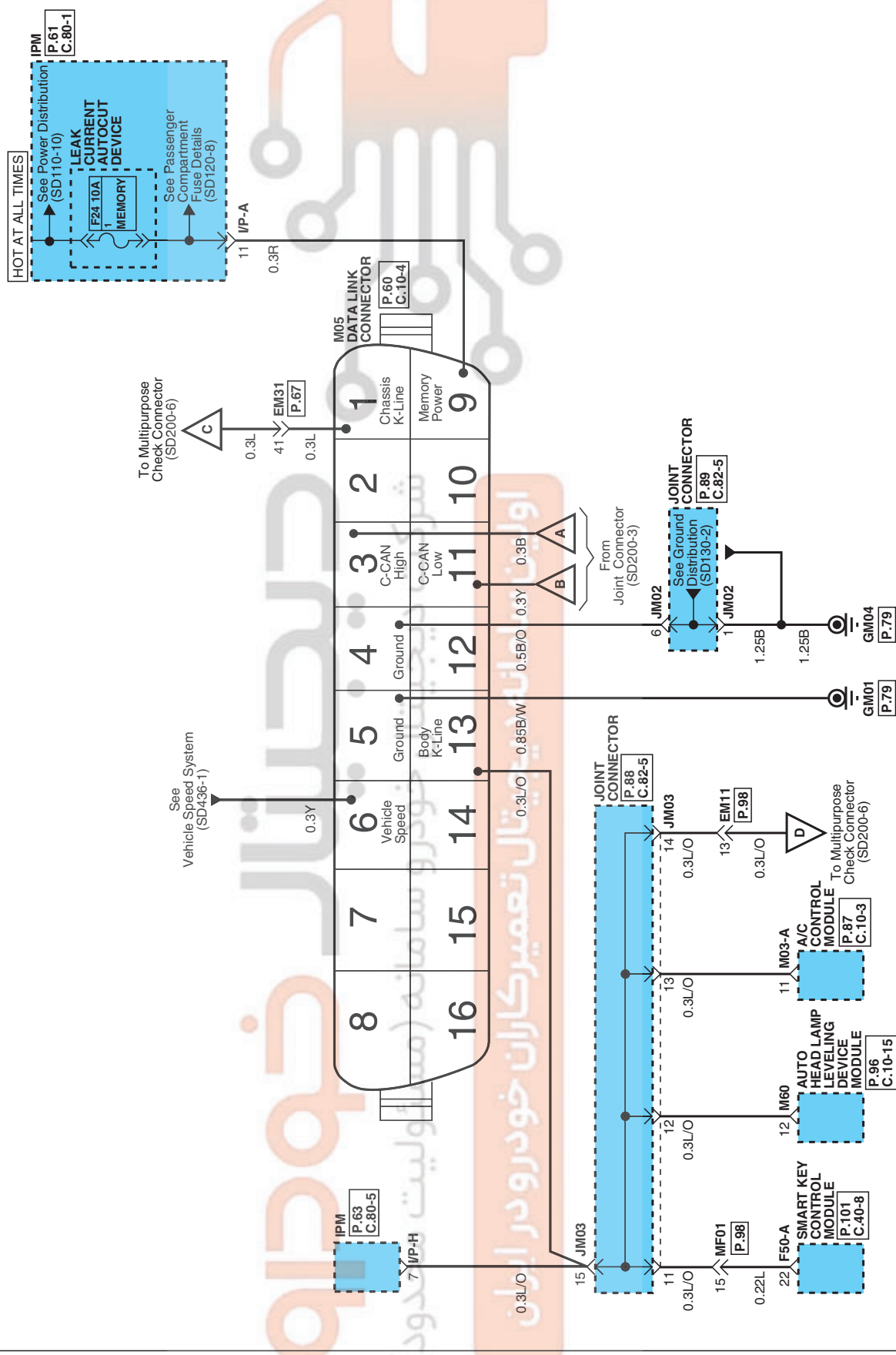

DATA LINK DETAILS

Data Link Details (3)

SD200-3

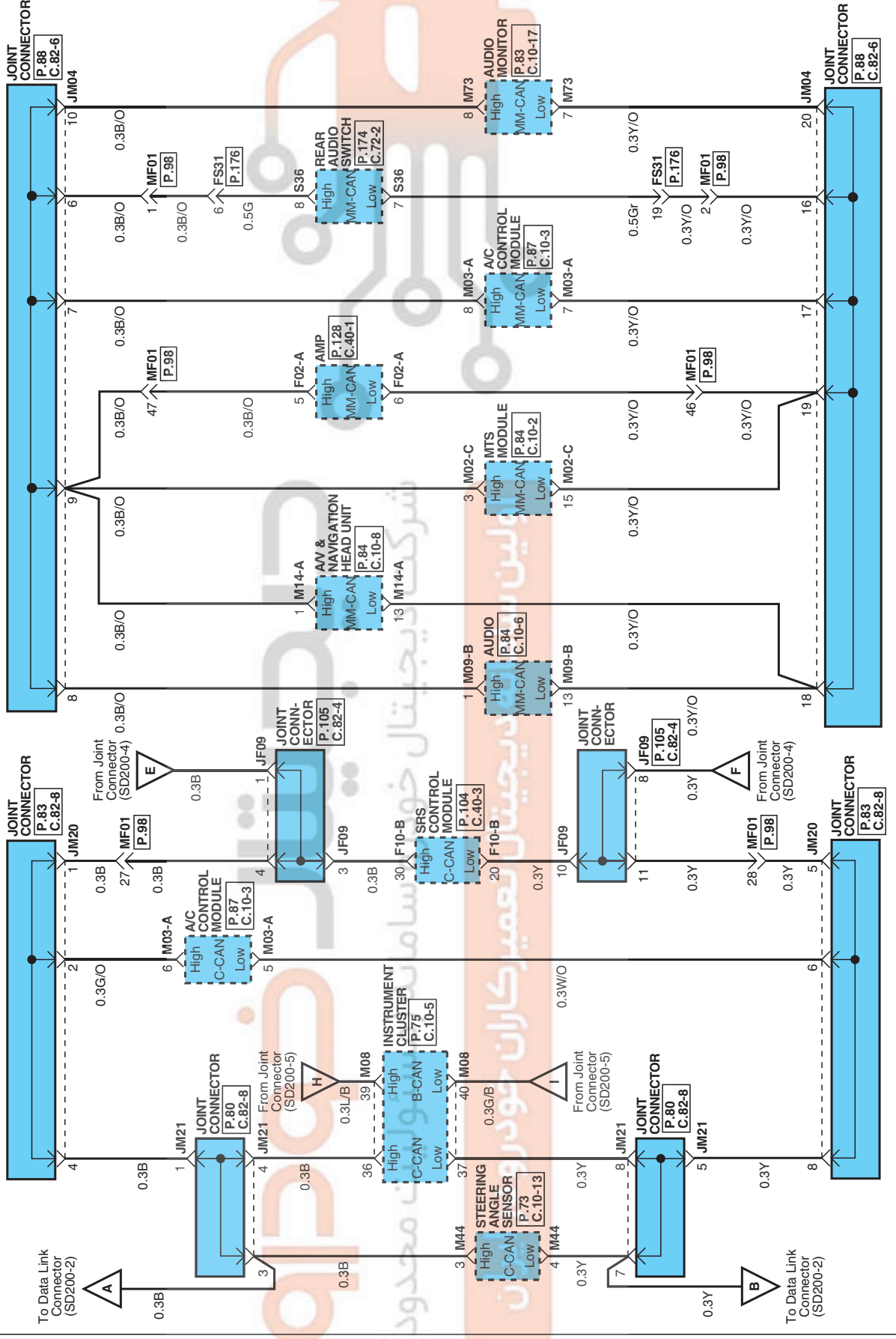

EVGSD12200CL

DATA LINK DETAILS

Data Link Details (4)

SD200-4

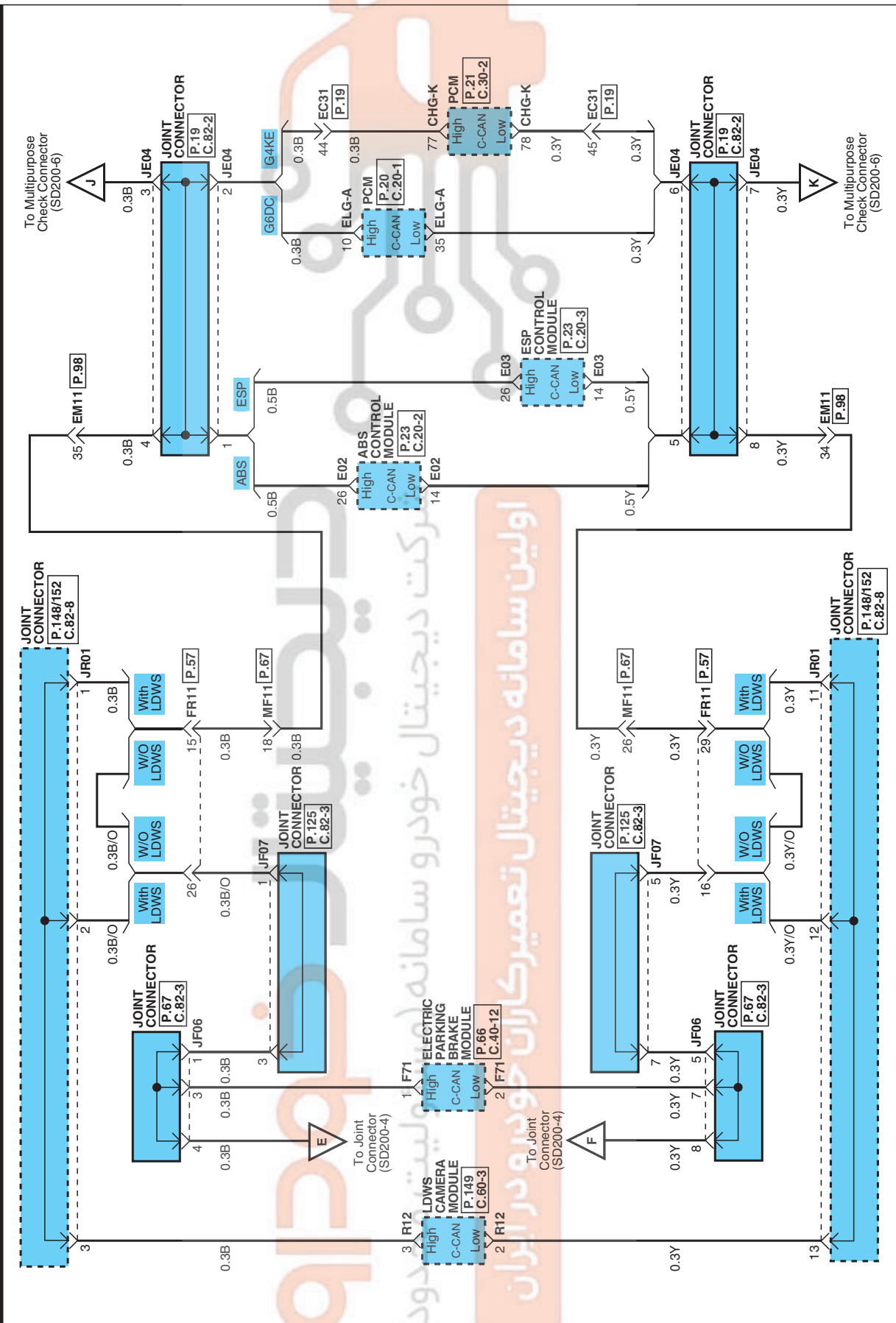

EVGSD1200DL

DATA LINK DETAILS

Data Link Details (5)

SD200-5

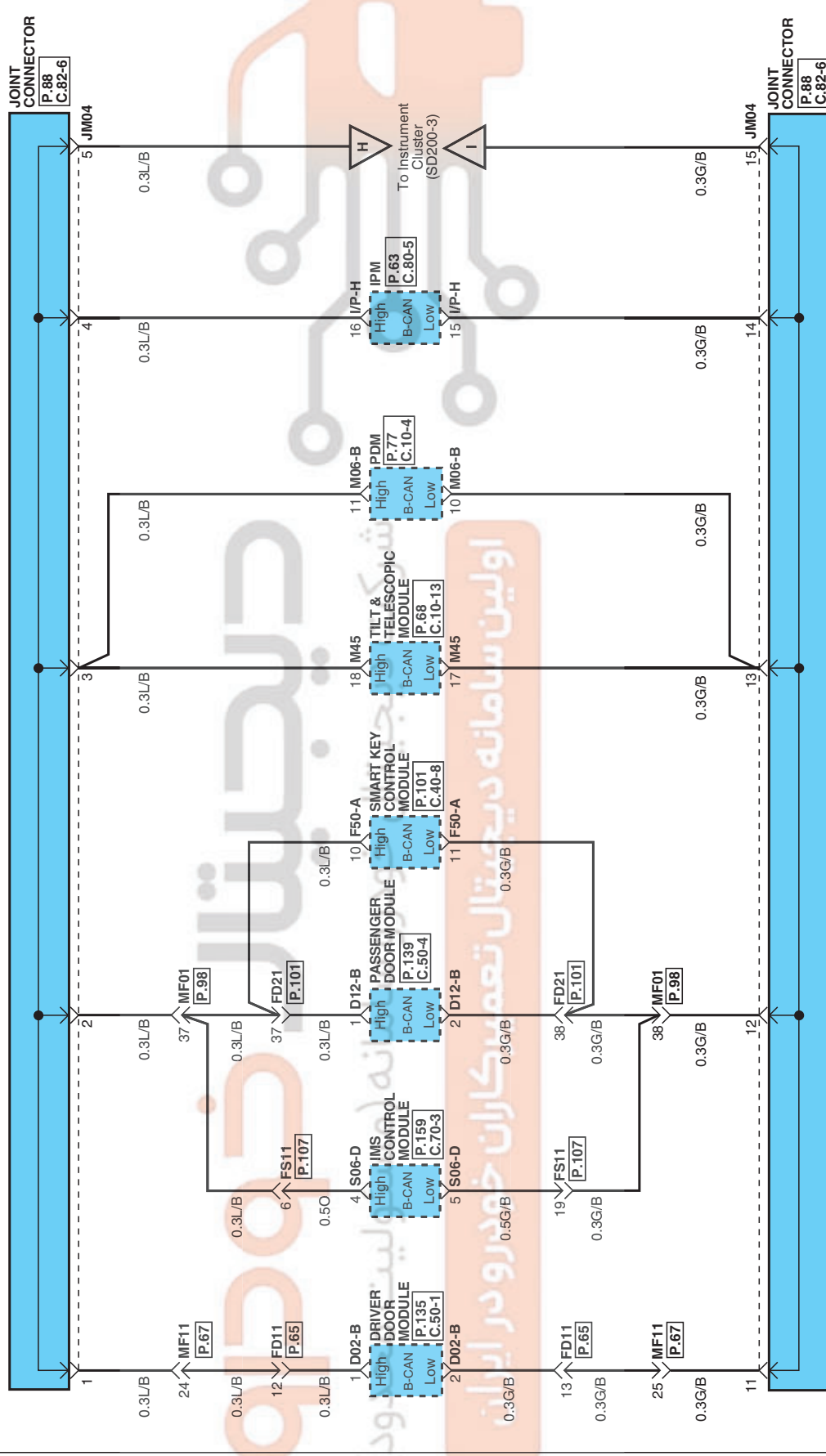

DATA LINK DETAILS

Data Link Details (6)

SD200-6

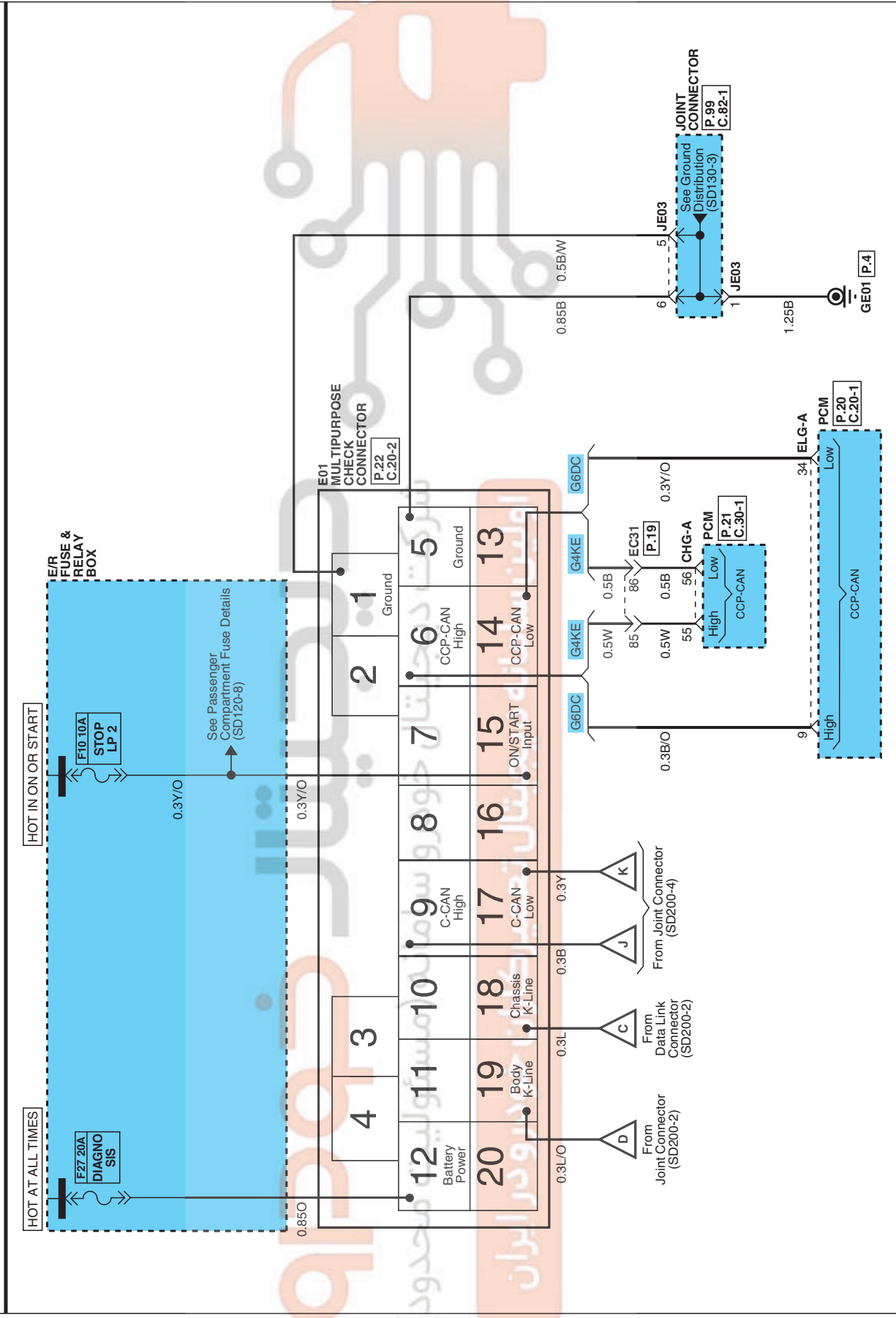

EVGSD1200FL